

**KIMTRON MODEL KT-7 VIDEO TERMINAL
OPERATOR'S GUIDE**

KIMTRON CORPORATION

**1705 Junction Court
Building #160
San Jose, California 95112
Telephone: (408) 727-1510
TWX: 910-338-0237**

Copyright 1983 by Kimtron Corporation. All rights Reserved. No part of this publication may be reproduced, transmitted, transcribed, stored in a retrieval system, or translated into any language or computer language, in any form or by any means, electronic, mechanical, magnetic, optical, chemical, manual, or otherwise, without the prior written permission of Kimtron Corporation.

DISCLAIMER

"Kimtron Corporation makes no representations of warranties with respect to this manual. Furthermore, Kimtron Corporation reserves the right to make changes in the specifications of the product described within this manual at any time without notice and without obligation of Kimtron Corporation to notify any person of such revision or changes."

WARNING

Keep away from live circuits

"This equipment generates, uses, and can radiate radio frequency energy, and if not installed and used in accordance with the instruction manual may cause interference to radio communications. This product has been tested for compliance with the limits for Class A computing devices pursuant to Subpart J of Part 15 of FCC Rules, which are designed to provide reasonable protection against such interference. Operation of this equipment in a residential area is likely to cause interference, in which case, the user, at his own expense, will be required to take whatever measures may be required to correct the interference."

WARNING

Voltage hazardous to human life are exposed within the cabinet. Use extreme caution when servicing either the power supply or any area where power terminals are exposed.

CAUTION

Under certain conditions, dangerous potentials may exist when the power is off, because of charges retained by capacitors and the CRT. To avoid injury, always remove power and discharge a circuit to ground before touching it. Never reach into the cabinet to service the equipment unless someone capable of giving aid is present.

ADDITIONAL WARNING

If the CRT tube should break, always wear heavy rubber gloves or use tongs to pick up the broken CRT pieces. The coating on the inside of the tube is poisonous.

WARRANTY AND WARRANTY RETURN PROCEDURE

Kimtron Corporation warrants that its products will be free from defects in material and workmanship for a period of 90 days from the date of shipment from the factory.

If a customer experiences a defect in either workmanship or materials during the warranty period, notify your supplier immediately. Your supplier may repair the terminal or determine if some other action is to be taken. In the event that a return of the terminal is deemed necessary, obtain a RETURN GOODS AUTHORIZATION (RMA) NUMBER from your supplier.

Repack the equipment in the original packing material and ship it in accordance with your supplier's shipping instructions. Make sure that the RMA number is clearly marked on the shipping label. Your supplier will not accept delivery of a return shipment without the proper RMA number.

SERVICE AND TECHNICAL ASSISTANCE

If your terminal requires service and it is out of warranty, you should follow the same procedure with your supplier as explained in WARRANTY RETURN PROCEDURE. Your supplier will be happy to provide you with any technical assistance pertaining to the use or maintenance of the terminal. Be well prepared with all of the necessary and specific information before you place a call to your supplier.

NOTE

Record the date of purchase and serial number of your terminal in the space provided below. The serial number is located on the back of the terminal.

Terminal Serial Number: _____

Date of Purchase: _____

REVISION CONTROL RECORD

As information pertaining to this product changes, revised pages may be issued. Changes will be noted by a heavy vertical bar in the margin. Replace the outdated page(s) with the revised page(s) and make note of this occurrence in the space provided below.

Page

Revision

TABLE OF CONTENTS

| | |
|--|------------|
| 1. INTRODUCTION | 1-1 |
| 1.1 Overview of this Document | 1-1 |
| 1.2 How to Use This Manual | 1-2 |
| 1.3 Conventions | 1-2 |
| 2. TERMINAL DESCRIPTION AND SPECIFICATIONS | 2-1 |
| 2.1 General Description | 2-1 |
| 2.2 Display Characteristics | 2-1 |
| 2.3 Keyboard Characteristics | 2-1 |
| 2.4 Communications Characteristics | 2-2 |
| 2.5 Technical Specifications | 2-2 |
| 3. INSTALLING THE TERMINAL | 3-1 |
| 3.1 Installation Overview | 3-1 |
| 3.2 Receiving Inspection | 3-1 |
| 3.3 Site Preparation | 3-1 |
| 3.4 Unpacking Instructions | 3-2 |
| 3.5 Shipping Damage Inspection | 3-3 |
| 3.6 Power Configuration | 3-3 |
| 3.7 Cable Connections | 3-4 |
| 3.7.1 Keyboard Connection | 3-4 |
| 3.7.2 Main Port Connection | 3-4 |
| 3.7.3 Auxiliary Device Connection | 3-5 |
| 3.7.4 Power Supply Connection | 3-5 |
| 3.8 Power-On | 3-5 |
| 3.9 Installation Checks | 3-5 |
| 4. SET-UP PROCEDURES | 4-1 |
| 4.1 Initial Options | 4-1 |
| 4.1.1 Cursor Type | 4-1 |
| 4.1.2 Auto Line Feed | 4-2 |
| 4.1.3 Duplex Mode | 4-2 |
| 4.2 Set-Up Mode | 4-2 |
| 4.2.1 Set-Up Line A | 4-3 |
| 4.2.2 Set-Up Line B | 4-5 |
| 4.3 Set-Up Checks | 4-8 |
| 5. DATA COMMUNICATIONS AND TERMINAL INTERFACING | 5-1 |
| 5.1 Overview | 5-1 |
| 5.2 Interfaces | 5-1 |
| 5.2.1 Main Port Interface | 5-1 |
| 5.2.2 Auxiliary Port Interface (Printer Port) | 5-2 |

| | | |
|-----------|---|------------|
| 5.2.3 | Bidirectional Print | 5-2 |
| 5.2.4 | Keyboard Interface | 5-2 |
| 5.3 | Communications Modes | 5-3 |
| 5.3.1 | Conversation Mode | 5-3 |
| 5.3.2 | Block Mode | 5-3 |
| 5.3.3 | Local Mode | 5-3 |
| 5.4 | X-On/X-Off Control | 5-3 |
| 5.5 | DTR Control | 5-3 |
| 5.6 | Software Reset | 5-3 |
| 6. | BASIC OPERATING INSTRUCTIONS | 6-1 |
| 6.1 | General Information | 6-1 |
| 6.2 | Adjusting Brightness | 6-1 |
| 6.3 | Keyboard Layout | 6-1 |
| 6.4 | Function of Keys | 6-2 |
| 6.4.1 | Alphanumeric Keys | 6-2 |
| 6.4.2 | Standard Control Keys | 6-2 |
| 6.4.3 | Editing Keys | 6-3 |
| 6.4.4 | Numeric Keys | 6-5 |
| 6.4.5 | Communications Keys | 6-5 |
| 6.4.6 | Device Control Key | 6-6 |
| 6.4.7 | Programmable Function Keys | 6-6 |
| 6.5 | Use of Status and User Lines | 6-6 |
| 6.5.1 | Description of Status Line Fields | 6-7 |
| 6.5.2 | Status Line Disable | 6-9 |
| 6.5.3 | Description of the User Line | 6-10 |
| 6.6 | Entering and Editing Data | 6-10 |
| 6.6.1 | General Information | 6-10 |
| 6.6.2 | Moving the Cursor | 6-10 |
| 6.6.3 | Editing Data | 6-10 |
| 6.6.4 | Setting and Clearing Tabs | 6-11 |
| 6.6.5 | Setting the Margin Bell | 6-11 |
| 7. | ADVANCED OPERATING INSTRUCTIONS | 7-1 |
| 7.1 | Additional Editing Functions | 7-1 |
| 7.2 | Addressing the Cursor | 7-2 |
| 7.3 | Reading the Cursor | 7-2 |
| 7.4 | Video Attributes | 7-4 |
| 7.5 | Protect Mode | 7-5 |
| 7.5.1 | Overview | 7-5 |
| 7.5.2 | Procedure for Protecting Data | 7-6 |
| 7.6 | Transmitting Screen Data to the Host | 7-6 |
| 7.7 | Communication with the Auxiliary Device | 7-7 |
| 7.8 | Selecting Termination Character | 7-8 |
| 7.9 | Programming Function Keys | 7-8 |

| | | |
|------|--------------------------------------|------|
| 7.10 | Answerback | 7-9 |
| 7.11 | Keyboard Lock/Unlock | 7-10 |
| 7.12 | Time of Day Clock | 7-10 |
| | 7.12.1 Set Time of Day | 7-10 |
| | 7.12.2 Send Time of Day | 7-10 |
| | 7.12.3 Print Time of Day | 7-10 |
| 7.13 | Monitor Mode | 7-10 |
| 7.14 | Graphics Mode | 7-11 |
| 7.15 | Background | 7-11 |
| 7.16 | Foreign Character Sets | 7-13 |
| 7.17 | Keyboard Keyclick | 7-13 |
| 7.18 | Terminal Emulation | 7-13 |
| 8. | OPTIONS | 8-1 |
| | 8.1 Amber Color Screen | 8-1 |
| | 8.2 Additional Pages of Memory | 8-1 |
| | 8.3 Current Loop Interface | 8-1 |
| | 8.4 Expansion Capability | 8-1 |
| 9. | PREVENTIVE MAINTENANCE | 9-1 |
| | 9.1 Cleaning the Terminal | 9-1 |
| | 9.2 Inspecting the Terminal | 9-1 |
| | 9.3 Replacing the Battery | 9-1 |
| 10. | TROUBLESHOOTING GUIDE | 10-1 |
| | 10.1 General Information | 10-1 |
| | 10.2 Troubleshooting Guide | 10-1 |

APPENDIX

- A QUICK REFERENCE TO TERMINAL FUNCTIONS**
- B CONTROL CHARACTER SYMBOLS**
- C FILL CHARACTER REQUIREMENTS**
- D USASCII CHART (CODES GENERATED FOR ENGLISH CHARACTER SET)**

LIST OF TABLES

| | | |
|-------------|---|-------------|
| 4-1 | Default Values at Power-On | 4-1 |
| 4-2 | Cursor Selection Codes | 4-1 |
| 4-3 | Duplex Selection Codes | 4-2 |
| 4-4 | Set-Up Line A: Options Available | 4-3 |
| 4-5 | Set-Up Line B: Options Available | 4-6 |
| 5-1 | Pin Connections: Main Port Interface | 5-1 |
| 5-2 | Pin Connections: Auxiliary Port Interface | 5-2 |
| 5-3 | Pin Assignments: Keyboard Interface | 5-2 |
| 6-1 | Standard Control Keys | 6-2 |
| 6-2 | Editing Keys | 6-3 |
| 6-3 | Communications Keys | 6-5 |
| 6-4 | Status Line Fields | 6-8 |
| 7-1 | Advanced Editing Commands | 7-1 |
| 7-2 | Cursor Addressing Codes | 7-3 |
| 7-3 | Video Attribute Codes | 7-5 |
| 7-4 | Data Transmission (To Host) Escape Codes | 7-7 |
| 7-5 | Communications Functions with the Auxiliary Device | 7-7 |
| 7-6 | Values of Parameter P1 | 7-9 |
| 7-7 | Values of Parameter P2 | 7-9 |
| 7-8 | Graphics Mode Character Conversions | 7-12 |
| 10-1 | Troubleshooting Guide | 10-1 |

LIST OF FIGURES

| | | |
|------------|--|-------------|
| 3-1 | How to Assemble Main Cabinet and Pedestal | 3-2 |
| 3-2 | Kimtron Model KT-7 Video Terminal - Interior View | 3-3 |
| 3-3 | Rear View - Kimtron KT-7 Video Terminal | 3-4 |
| 4-1 | Set-Up Line A | 4-3 |
| 4-2 | Set-Up Line B | 4-6 |
| 6-1 | Kimtron Model KT-7 Keyboard Layout | 6-1 |
| 6-2 | Status Line | 6-7 |
| 7-1 | Kimtron Model KT-7 Video Attributes | 7-4 |
| 7-2 | Sample Form Created on the Kimtron Model KT-7 | 7-6 |
| 7-3 | German Character Set: Keyboard Layout | 7-13 |
| 7-4 | French Character Set: Keyboard Layout | 7-13 |
| 7-5 | Spanish Character Set: Keyboard Layout | 7-13 |

1. INTRODUCTION

1.1 Overview of this Document

This Operator's Guide is designed to assist you to install, operate, program and take care of your new Kimtron Model KT-7 terminal. As you proceed through the Operator's Guide, you will find the following sections:

Section 2: Terminal Description and Specifications

This section will provide an overall description of the features and functions of the standard Kimtron Model KT-7 terminal. Detailed specifications are also provided.

Section 3: Installing the Terminal

The information required to prepare the work area, unpack and inspect the terminal, configure the terminal for operation, connect the terminal to various devices, and turn on the terminal power is provided in this section. Installation checks are also included.

Section 4: Set-Up Procedures

Your new terminal eliminates the need for setting switches to configure it properly. Instead, a Set-Up Mode is accessed. This section covers the available set-up parameters, how to change them and how to verify correct set-up procedures.

Section 5: Data Communication and Terminal Interfacing

The terminal operates in Block or Conversational Mode (In either half or full duplex). An explanation of these modes is included in this section, as well as pertinent information on X-On/X-Off and DTR controls, terminal interfaces, and Local mode operation.

Section 6: Basic Operating Instructions

Adjusting the brightness of the screen, the keyboard layout and function of keys, using the Status and User Lines, moving the cursor, and basic instructions for entering and editing data are provided in this section.

Section 7: Advanced Operating Instructions

Use of escape and control sequences can affect many of the terminal functions and features. This section provides information on the more advanced/technical terminal applications.

Section 8: Options

Several options are available for purchase. This section lists and discusses each of them.

Section 9: Preventive Care

This section discusses periodic inspection and cleaning of the terminal.

Section 10: Troubleshooting Guide

This is a basic guide to determining solutions to simple operational problems.

NOTE

Section 4 and 7 discusses the native emulation utilize supplement sheets for other emulations: VT-100/52.

1.2 How to Use This Manual

It is important to read this Operator's Guide thoroughly before using this product. Reading Sections 2 through 5 of this manual is extremely important, as all the basic information necessary to install and operate the terminal is contained in these sections.

A complete Table of Contents, List of Figures and List of Tables is provided at the front of this manual. If you have difficulty finding information, and do not find it listed in the front matter, consult the detailed subject index at the end of this manual.

Reference is made throughout this manual to escape and control code sequences. A "Quick Reference Guide to Terminal Functions", Escape and control Code Sequences, an ASCII chart, and various other technical tables are provided as appendices to explain these codes.

1.3 Conventions

A few conventions are consistent throughout this manual, and should be understood before you begin operating your terminal:

1. The characters ESC represent the ESC (Escape) key located on the keyboard. When you see these characters, you are to press the ESC key; do not type the actual characters ESC.
2. Escape code sequences are listed as ESC x, where x is the code to be entered. Please note that the space separating the characters ESC and x is for clarity; do not enter the space character (space bar). If you are supposed to press the space bar in a control or escape code sequence, this will be indicated by the word SPACE.
3. Control code sequences are listed as CTRL/X, where X is part of the code to be entered. Unlike the ESC code sequence where each key is pressed independently, the keys pressed in a CTRL code sequence are entered while the CTRL key is pressed. You must hold down the CTRL key while typing the character following CTRL in the command sequence. This is similar to using the SHIFT key to enter an upper case "S"; you must depress the SHIFT key while typing the character "S".
4. The word SHIFT or Shift indicates that you are to use the SHIFT key when entering a command or code sequence.

2. TERMINAL DESCRIPTION AND SPECIFICATIONS

2.1 General Description

The Kimtron Model KT-7 video terminal is a sophisticated data communications terminal. It supports various communications protocols, enables connection to two separate devices simultaneously, and provides non-volatile memory for storage of desired contrast setting, set-up parameters, programmable functions and programmable answerback.

2.2 Display Characteristics

The data image displayed on the screen of the 12 inch diagonal CRT consists of 24 lines of 80 columns each. The displayed characters may be entered from the keyboard or received from the host. A special 25th line of the screen is used as a Status Line for displaying various terminal status data, displaying function key or answerback data as these keys are being programmed, or as a User Line for displaying programmed user message data.

A total of 254 characters may be displayed on the screen; this includes the 128 ASCII characters (96 alphanumeric and 32 control), 15 character line graphics set, 32 international characters, 20 special and math symbols and 59 thick line and block graphics set.

In the Monitor mode, all 128 characters in ASCII code (including control characters) are displayed on the screen.

There are five visual attributes available on the Kimtron Model KT-7 video terminal: Reverse, Blinking, Underline, Half-Intensity and Blank Video. These attributes, with the exception of Half-Intensity, may be programmed to take up a cursor space (embedded) or programmed not to take up a cursor space (hidden or non-embedded). Low intensity is always non-embedded.

2.3 Keyboard Characteristics

This terminal uses a typewriter-style keyboard layout. In addition to the standard alphanumeric keys, this keyboard has additional keys: a numeric key pad, special function keys and programmable function keys.

With the exception of LOCAL, CTRL, CAPS LOCK, SHIFT, BREAK, XMIT, PRINT special function keys and the ten PF keys, all keys on the keyboard are typamatic. This means that a key will be automatically repeated if it is held down for more than 0.5 seconds. Key functions automatically repeat at the rate of approximately 15 characters per second, until the key is released.

Two-key rollover is another feature of this keyboard. When two keys are struck at the same time, both are displayed. If held depressed, only the latter will repeat. When two or more keys are pressed at the same time, only two keys are transmitted to the terminal in the order they were entered. Neither of these keys will be repeated until the third is released.

2.4 Communications Characteristics

This terminal has a Main Port (J1) and an Auxiliary Port (J2) which provide EIA RS-232C compatible interfaces. 15 baud rates of up to 19,200 bps are available for the Main Port, and up to 19,200 bps for the Auxiliary Port. Baud rate, Word length, Parity and Stop bit settings for each port may be selected independently.

The Main interface is provided for communication between the host and the terminal. Both X-On/X-Off and DTR control protocols are supported by the main port; this interface can also be configured for optional current loop operation instead of EIA voltage level operation.

The Auxiliary interface is provided for communication between the terminal and an auxiliary device (typically a serial printer). This port recognizes both X-On/X-Off and Busy/Ready signal generated by the printer. It can be configured for bidirectional communication with an auxiliary device or transparent communication between the host and the auxiliary device.

Data communication is asynchronous, and the word length can be either 9, 10 or 11 bits. If parity is enabled, the transmitted parity bit may be either odd or even, and the received parity bit will be checked by the terminal. If parity is disabled, the transmitted parity bit can be either mark or space, and the received parity bit will not be checked by the terminal. If no parity is set, the parity is neither generated nor checked by the terminal.

2.5 Technical Specifications

DISPLAY

CRT: 12 or 14 inch diagonal

Status Line: 25th line

Character: 7 x 9 dot matrix
(in 9 x 13 dot matrix field)

Paging: Up to three additional pages

Character Set: 128 ASCII plus
15 line graphics set,
4 international character sets,
(English, French, German, Spanish)
20 special and math symbols and
59 thick line and block graphics set

Video Attributes: Blinking (Hidden/Embedded)
Underline (Hidden/Embedded)
Half Intensity (Hidden only)
Reverse (Hidden/Embedded)
Blank (Hidden/Embedded)
Line or Page (In embedded mode)

Cursor Type: Underline/Block
in Static/Blinking
or Blank Cursor

EDITING FUNCTIONS

Margin Bell

Forward and reverse Tab, Tab Set, Tab Clear, All Tab Clear

Character Insert/Delete

Line Insert/Delete

Cursor Control : Up, Down, Left, Right, Home, Return, Line Feed, Back Space, Cursor Addressing and Reading, Tab and Back Tab

Erase : Character, End of Line, End of Page, Unprotected, All

PROGRAMMABLE FUNCTION KEY : 20 Programmable function keys Programmable up to 24 characters for each key

PROGRAMMABLE ANSWER BACK : Programmable up to 16 characters

COMMUNICATION

(Main Port)

Type : EIA RS-232C
Optional 20 mA Current Loop

Speeds : 50, 75, 110, 135, 150, 300, 600, 1200, 1800, 2400, 3600, 4800, 7200, 9600, 19200 bps

Parity : Even, Odd, Mark, Space, No Parity

Method : ASCII, Asynchronous, Serial

Protocol : X-On/X-Off, DTR

Modes : Half Duplex, Full Duplex, Block

(Auxiliary Port)

Type : EIA RS-232C

Speeds : 50, 75, 110, 135, 150, 300, 600, 1200, 1800, 2400, 3600, 4800, 7200, 9600, 19200 pbs

Parity : Even, Odd, Mark, Space, No Parity

Method : ASCII Asynchronous Serial

Protocol : X-On/X-Off and Busy/Ready interpreted by terminal

Modes : Unidirectional print, Bidirectional print, transparent print

KEYBOARD

Typewriter-Style
Detachable
Sculptured Style
2-Key Rollover
Keyboard Lock/Unlock
Keyclick : Electronic Sound
Auxiliary Keypad : Numeric Pad with Comma, Decimal, Minus and Enter
Keys with LED : Alpha Lock

POWER

Line Voltage : 115/230 V
Line Frequency : 50 Hz/60 Hz
Power Consumption: 45 Watts

ENVIRONMENTAL

Temperature : 10 to 40°C (50 to 104°F)
Humidity : 10% to 90%
Altitude : Up to 3000 meters

MECHANICAL

Dimensions : Cabinet Height — 360mm (14.2 inches)
— include option neck 420mm (16.5 inches)
Width — 328mm (12.9 inches)
Depth — 339mm (13.3 inches)

Keyboard Height — 36.5mm (1.4 inches)
Width — 455mm (17.9 inches)
Depth — 186mm (7.3 inches)

Weight: Terminal : 8.3 kg (18.4 pounds)
: include option neck 8.5 kg (18.8 pounds)
Key board: 1.5 kg (3.3 pounds)

Shipping Weight: 12.5 kg (27.6 pounds)

NOTE

Specifications Subject to Change Without Prior Notice.

3. INSTALLING THE TERMINAL

3.1 Installation Overview

This section contains procedures for installing the Kimtron Model KT-7 video terminal. It includes instructions for unpacking and inspection, explains the procedures for connecting the terminal to the keyboard, peripheral devices and power source; and details initial set-up for communication with the host system and auxiliary device.

3.2 Receiving Inspection

When the terminal is delivered by a transfer company, it must be carefully inspected for damage. Prior to accepting delivery, carefully inspect the shipping container for obvious damage. If damage is sighted, note it on the waybill and require that the delivery agent sign the waybill. Notify the transfer company immediately, and submit a damage report to the carrier.

NOTE

If the terminal must be reshipped for any reason, it must be repacked in a manner that will prevent damage while in transit. Damage caused by improper packaging will not be covered under warranty.

3.3 Site Preparation

There are very few constraints to selecting the desired work space in which to install your terminal. Extreme temperature and/or humidity, however, should be avoided.

The Kimtron Model KT-7 requires an area 16.5 inches (420 mm) high x 12.9 inches (328 mm) wide x 13.3 inches (339 mm) deep. Additional space for ventilation clearance is not required. Terminal weight (including keyboard) is 21.7 pounds (10 kg).

The installation site should have a 115 Vac 60 Hz at 65 watts power source in the immediate vicinity; in the United States, this is a NEMA standard 5-15R, 3-prong receptacle. To ensure adequate protection from electrical shock and provide immunity from stray fields, a proper ground must be provided on the power source.

This equipment contains a semiconductor memory device in which various setup data are stored. This device is very sensitive to electrical surge, fluctuation, broadband noise, or unusually high levels of electrostatic discharge through the equipment. If this equipment is exposed to any one or a combination of the above mentioned environments, changes in stored setup data may be observed. It is recommended that you eliminate the conditions described above. Action such as installing a constant voltage transformer and/or surge isolator, conductive mat, etc. can be taken.

NOTE

DO NOT PLUG IN THE TERMINAL until you read Section 3.4 below, and are sure the proper voltage setting has been selected.

3.4 Unpacking Instructions

The shipping carton contains the main unit with power cord, keyboard, Operator's Guide and keyboard cable. Follow the procedure outlined below to properly unpack these items.

1. Remove all packing material. Save all packing materials for possible use in reshipping the terminal.
2. Read this section of the Operator's Guide thoroughly before proceeding.
3. Carefully lift the keyboard and video terminal out of the box and place it in the desired work area. Ensure that air can circulate freely around the rear, base and top of the unit. Check that cables are free of kinks or tight bends. The main cabinet and pedestal are shipped separated. Assemble the main cabinet and the pedestal as follows:
 - a. Place the terminal upside down on a flat surface.
 - b. Attach the neck to the pedestal as shown in figure 3-1 (A). If use of the neck piece is not desired, skip this step.
 - c. Attach the pedestal to the main cabinet as shown in figure 3-1 (A) & (B). An indent in the bottom of the base is provided for rotating the pedestal 90° while being held slightly away from the base of the terminal.
 - d. Make sure the short end of the pedestal faces the front of the terminal.
 - e. Slide the pedestal along the guide groove to the rear side of the cabinet to locate the center of the pedestal at the protruded area (slide guide) of the main cabinet. Refer to figure 3-1 (C).
 - f. Erect the terminal, being careful not to damage the cabinet and the pedestal. An effective way is to hold the main cabinet tightly with both hands, lift it high enough and then place the terminal in the proper position.

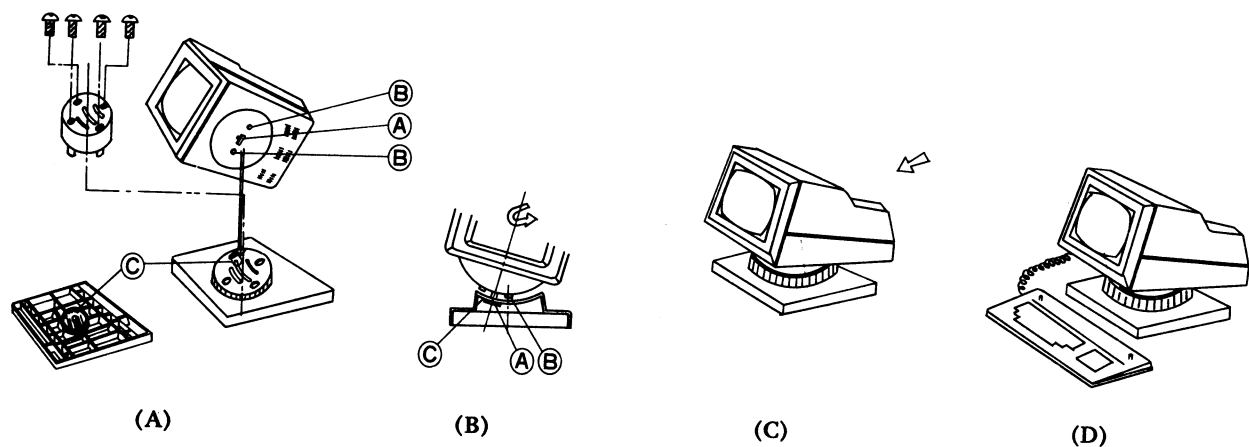

Figure 3-1: How to Assemble Main Cabinet and Pedestal

4. Inspect the video terminal for external damage.

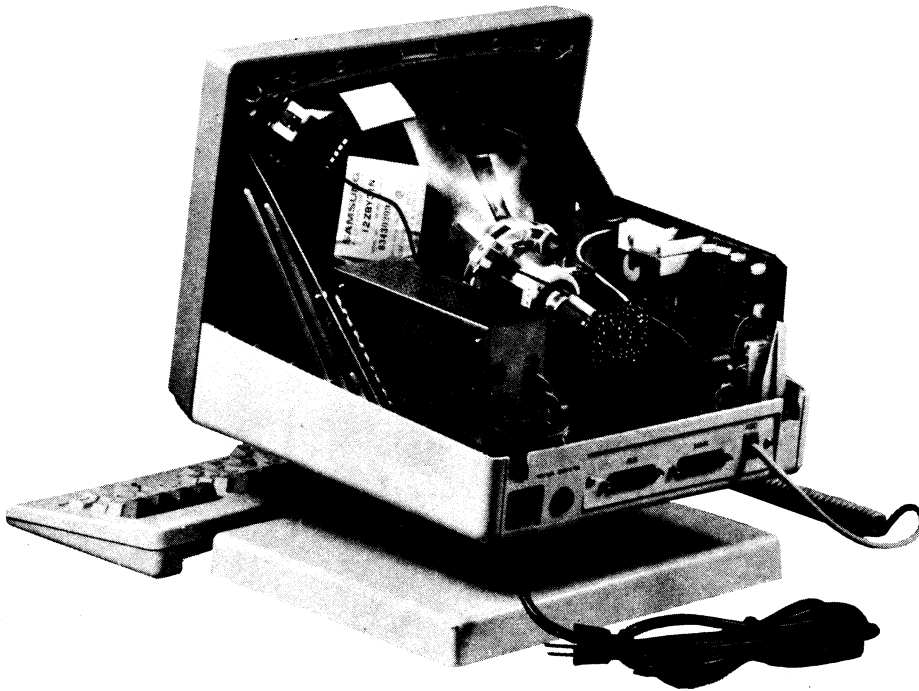

Figure 3-2: Kimtron Model KT-7 Video Terminal-Interior View

3.5 Shipping Damage Inspection

If damage to the video terminal is apparent, notify the transfer company immediately. Save all packing materials for the transfer company's inspection, and file a damage report with the carrier.

NOTE

Damage to equipment in transit is not covered under warranty.

Promptly notifying the transfer company of damage will ensure claim validity and will help expedite payment for necessary repairs by the transfer company or its insurance agent.

3.6 Power Configuration

The Kimtron Model KT-7 will operate at 115 Vac or 230 Vac, depending upon the rating of the user site power line. Locate the Voltage Selection Jumper on the power supply board inside Terminal. (115V is standard factory setting in the US). If the factory setting of this Jumper is not appropriate for the installation site, use the following modification procedures. This jumper must be properly set before turning on the terminal.

1. Remove the two screws located on the rear of the main unit, and lift off the cover.
2. Remove the three screws located on the side of the power module, and lift off the power shield case upper.
3. Set the voltage selection jumper for the proper voltage.

NOTE

Failure to set this jumper properly may result in damage to the terminal.

Also verify that the rating of the fuse, located in the fuse holder on the rear of the terminal, is adequate for input power. The standard fuse shipped from the factory is a 115V 1.0 amp fast blow fuse. For 230 VAC applications, a 250V 0.5 amp instantaneous (fast blow) fuse should be installed. (refer to note on page 10-3)

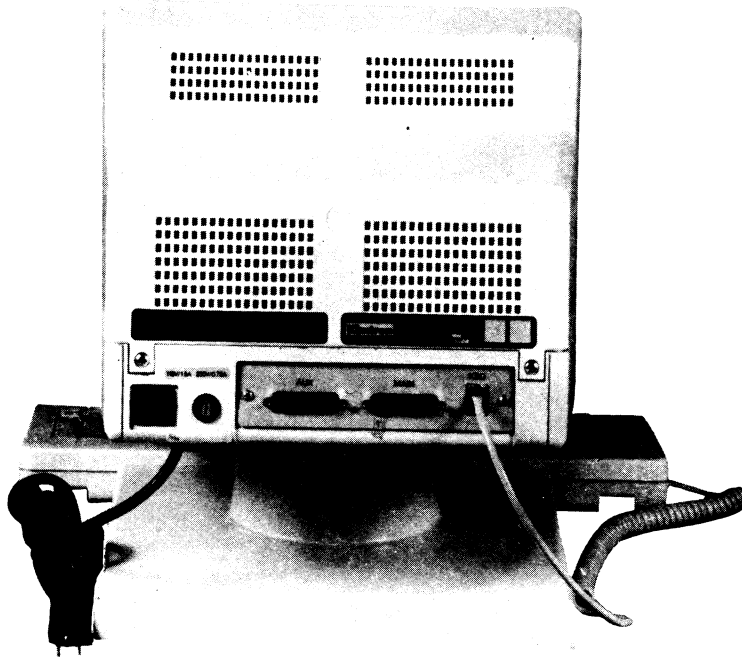

Figure 3-3: Rear View-Kimtron KT-7 Video Terminal

3.7 Cable Connections

The main unit of the video terminal must be connected to the keyboard. In addition, you will connect the terminal to either a computer system or communications device (modem, coupler, etc.) which will allow access to a remote computer system. Optionally, you may connect the terminal to a printer or other auxiliary device.

3.7.1 Keyboard Connection

One end of the keyboard cable must be plugged into the adapter located in left side of keyboard. The other end must be plugged into the adapter marked "KBD" located on the rear panel of the main unit (see Figure 3-3).

3.7.2 Main Port Connection

A standard RS-232C interface cable is required for connecting the Kimtron Model KT-7 terminal to the host system or communications device. This cable is not provided with your terminal.

Connect one end of the RS-232C EIA cable to the port labeled MAIN on the rear panel of the main unit. and the other end to the computer system/modem.

3.7.3 Auxiliary Device Connection

An auxiliary device, typically a serial printer, can be connected to the Model KT-7. This connection enables the printer to make a permanent copy of the data displayed on the screen. If you wish to connect a printer to your terminal, first verify that the printer has a serial interface, and is equipped with to X-On/X-Off protocol or Busy/Ready protocol. If this is the case, install one end of the RS-232C interface cable to the port labeled "AUX" on the rear panel of the main unit. Connect the other end of the cable to the printer.

3.7.4 Power Supply Connection

1. One end of the power cord is connected to the main unit.
2. Make sure that the POWER switch (located in the back lower left corner of the terminal) is in the OFF position. (refer to note on page 10-3)
3. Plug the terminal power cord into a grounded outlet (see Section 3.3, Site Preparation).

3.8 Power-On

Once you have completed the steps outlined in this section, and have verified the proper voltage selection and fuse rating, turn the power switch ON. If you see or smell smoke, turn the terminal OFF immediately.

3.9 Installation Checks

1. Within one or two seconds of power on, you will hear a "beep" tone from the video terminal.
2. Within five to 15 seconds, a rectangular block (CURSOR) will appear in the upper left corner of the screen. This is referred to as the "HOME" position.
3. Locate the BRIGHTNESS control volume on the bottom left corner of front terminal. Adjust this volume for the desired screen intensity.

NOTE

Brightness may have to be readjusted after the CONTRAST is set. Refer to Table 4-4 for information on contrast.

4. If the cursor is not visible, adjust the BRIGHTNESS control volume discussed in Step 3 above.
5. At the base of the screen (the 25th line) a "Status Line" will appear (see Figure 6-2). This line provides useful terminal status information and will be discussed further in Section 6.5.
6. Press the SHIFT and LOCAL/BREAK keys simultaneously. It is located in the upper Right side of the keyboard. Then "LOCAL" should be displayed in the middle of the Status Line.
7. Press each of the keys on the keyboard and verify that the characters typed are properly displayed on the screen.
8. Press the ALPHA LOCK key. It is located above the SHIFT key on the lower left side of the keyboard. The red light should illuminate. Repeat Step 7 above, and verify that the alphabetic characters are displayed in upper case.
9. Check operation of the RETURN key. Once the cursor is positioned at the 24th line (just above the status line), a RETURN should cause the cursor to return to the first column of the line on which it is located.

4. SET-UP PROCEDURES

The Kimtron Model KT-7 terminal allows the user to select various terminal parameters from the keyboard or the host system, eliminating cumbersome DIP switches.

The parameters, other than the default values at power-on, are set by the user and stored in the non-volatile memory of the terminal. These values will be in effect whenever the terminal is powered on. Power-on default values are outlined in Table 4-1 below. These default values are restored upon power-on.

Table 4-1: Default Values at Power-On

| | | | |
|----------------|------------------------------|-----------------|--------------------------|
| Enabled Modes: | Conversation (FDX) | Disabled Modes: | Graphics Mode |
| | On-Line | | Multiple Insert Mode |
| | Margin Bell at Column 72 | | Transparent Print Mode |
| | Normal Screen | | Bidirectional Print Mode |
| | Tab stop at every 8th column | | Local Edit Mode |
| | | | Protect Mode |
| | | | Monitor Mode |

4.1 Initial Options

Besides the parameters that can be accessed through the Set-Up mode, the operator can also change the type of cursor displayed on the screen, enable the Auto Line Feed function (if so desired), and select the duplex required for communication with the host computer system. Make sure that the terminal is in LOCAL mode (the Status Line displays the word "LOCAL").

4.1.1 Cursor Type

The default type of cursor, when shipped from the factory, is the static (non-blinking) rectangular block. Table 4-2 lists the available types of cursor display, and provides the escape sequence required to enable the desired cursor type. Make sure to enter the appropriate escape sequence in LOCAL mode:

Table 4-2: Cursor Selection Codes

| | |
|-------------------------|---------|
| Blinking Block | ESC . 1 |
| Static Block | ESC . 2 |
| Blinking Underline | ESC . 3 |
| Static Underline | ESC . 4 |
| Fast Blinking Block | ESC . 5 |
| Fast Blinking underline | ESC . 6 |
| No cursor display | ESC . 0 |

NOTE

Throughout this manual, the characters ESC represent the ESC (Escape) key. Do not type the characters ESC; press the ESC key (See Section 1.3, Conventions).

4.1.2 Auto Line Feed

The Kimtron Model KT-7 terminal is configured at the factory with the Auto Line Feed mode disabled. To enable Auto Line Feed, type:

ESC 8

If Auto Line Feed is enabled, each carriage return operation will position the cursor at the first column of the next line. Many computers generate a line feed as well as carriage return. If this is the case, a double line feed will be displayed. To eliminate this, type:

ESC 9

4.1.3 Duplex Mode

In Full Duplex mode, data entered from the keyboard is sent directly to the computer system. Once it reaches the computer, the data is typically "echoed" back to the terminal screen.

In Half Duplex mode (full duplex with local copy), data entered from the keyboard is sent directly to the computer system and is treated as received data by the terminal. Echoing is not required in this mode; if it is used, each transmitted character will be displayed twice on the screen.

Table 4-3 lists the escape sequences required to select duplex, when the terminal is in Conversation mode.

Table 4-3: Duplex Selection Codes

| | |
|-------------------|------------------|
| Conversation Mode | ESC C or CTRL/F2 |
| Full Duplex | ESC } or CTRL/F4 |
| Half Duplex | ESC { or CTRL/F3 |

4.2 Set-Up Mode

It is necessary to put the terminal in "Set-Up" mode and configure the terminal to meet the host system's requirements. This is accomplished by following the procedure below:

1. Verify that the terminal is in LOCAL mode. If it is On-Line, press the LOCAL key while pressing the SHIFT key so that the Status Line displays the word "LOCAL".
2. Once in the LOCAL mode, press the SHIFT and SET UP/NO SCROLL keys at the same time, or type ESC z.

Two SHIFT keys are provided near the base of the keyboard; either SHIFT key may be used.

The SET UP key is located in the lower row of the keyboard, and is labeled "SET UP NO SCRL". It is next to the LINE FEED key.

3. The previously displayed Status Line will be replaced by Set-Up Line A (see Figure 4-1). This line will display the current communication parameter values stored in the terminal's memory, and the screen refresh rate. The Contrast Control field is also located in this line.
4. Place the cursor in the appropriate field by using the Cursor Right (right arrow) or Cursor Left (left arrow) keys.
5. Change the value by pressing Cursor Up (up arrow) or Cursor Down (down arrow) to set the desired value.

6. Continue with Set Up Line B (see Figure 4-2), by pressing SHIFT/SET UP once more, or entering the cursor home code (1EH). This line contains other options available in the Kimtron Model KT-7 video terminal.
7. When you have completed setting up the parameters, exit from the Set-Up mode by either pressing the RETURN key or the SHIFT/SET UP key.

4.2.1 Set-Up Line A

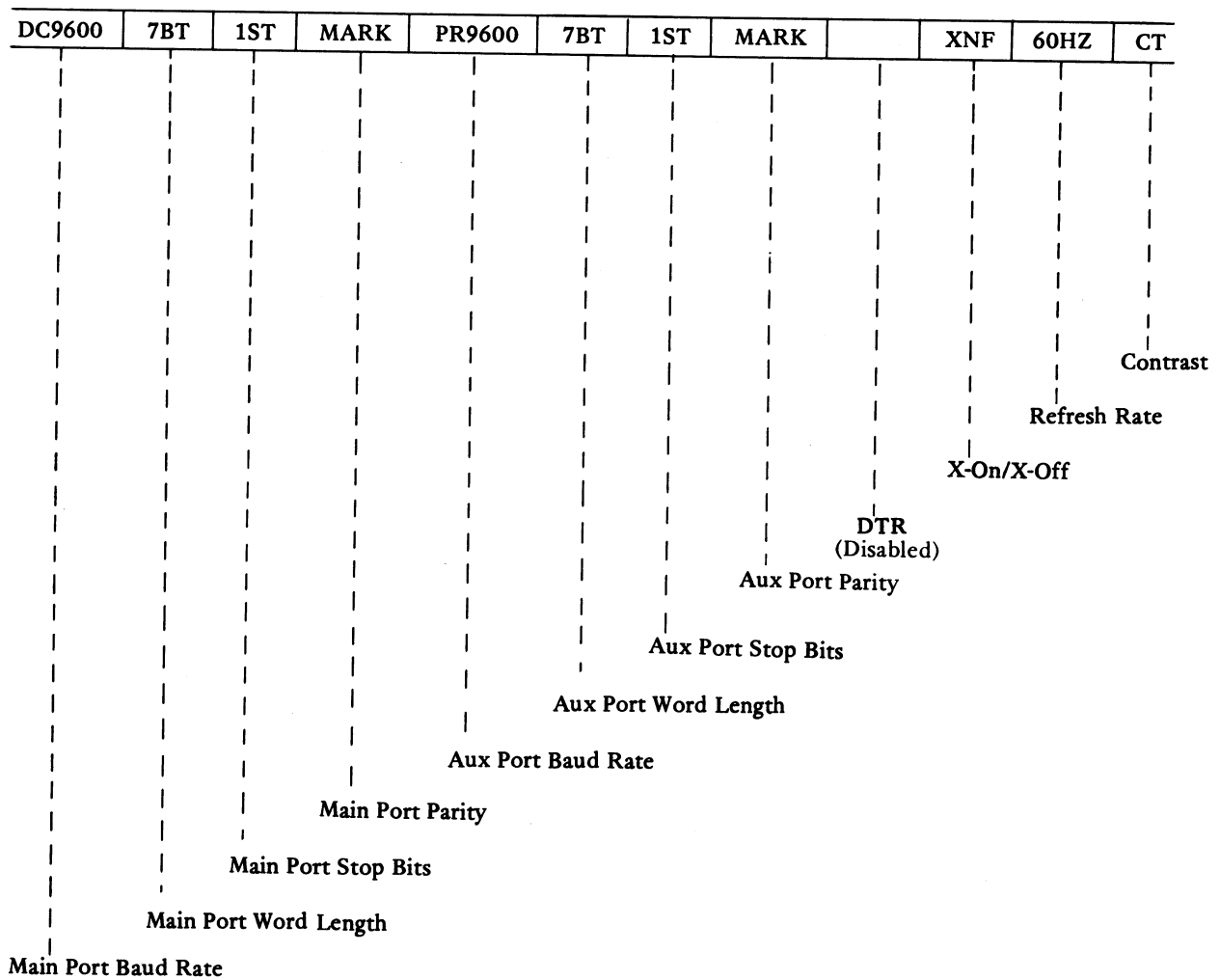

Figure 4-1: Set-Up Line A

Figure 4-1 and 4-2 show each parameter field and the factory default values of each field. To change any of these values, follow the instructions provided in the previous subsection. For a description of each field, refer to Table 4-4.

Table 4-4: Set-Up Line A: Options Available

Main Port (DC):

| | |
|--------------------|--|
| Baud Rate | This value must match the data rate required by the host for transmitting and receiving data. Available data rates are: 50, 75, 110, 135, 150, 300, 600, 1200, 1800, 2400, 3600, 4800, 7200, 9600, and 19200 bits per second (bps). |
| Word Length | The number of data bits in the word structure may be changed from seven (7) to eight (8) to match the host system's requirements. |
| Stop Bits | The number of stop bits (either one or two) may be selected, and are in effect at any baud rate during data transmission. |
| Parity | <p>The five standard parity modes are available for use with your system.</p> <p>Odd : Checks for odd parity on received data, and generates odd parity on outgoing data.</p> <p>Even: Checks for even parity on received data and generates even parity on outgoing data.</p> <p>Space: Parity bits are set to "0" on transmitted data. No parity check is done on received data.</p> <p>Mark: Parity bits are set to "1" on transmitted data. No parity check is done on received data.</p> <p>No Parity: No parity bit is generated or checked.</p> |

Auxiliary Port (PR):

| | |
|--------------------|--|
| Baud Rate | This value must match the data rate required by the printer or other auxiliary device for receiving data. Available data rates are: 50, 75, 110, 135, 150, 300, 600, 1200, 1800, 2400, 3600, 4800, 7200, 9600 and 19200 bits per second (bps). |
| Word Length | The number of bits in the word structure may be changed from seven (7) to eight (8) to match the printer's requirements. |
| Stop Bits | The number of stop bits (either one or two) may be selected, and are in effect at any baud rate during data transmission. |
| Parity | <p>The five standard parity modes are available for use.</p> <p>Odd: Checks for odd parity on received data, and generates odd parity on outgoing data.</p> <p>Even: Checks for even parity on received data and generates even parity on outgoing data.</p> <p>Space: Parity bits are set to "0" on transmitted data. No parity check is done on received data.</p> |

Mark: Parity bits are set to "1" on transmitted data. No parity check is done on received data.

No Parity: No parity bit is generated or checked.

NOTE

The values established for the auxiliary device (printer) are independent of the Main Port values.

Remaining Options:

DTR When this field is blank, DTR control is disabled. If the field displays "DTR", it is enabled.

X-On/X-Off If X-On/X-Off protocol is required by the host, toggle the value so that the characters XNF are displayed.

Refresh Rate This field enables 50 Hz or 60 Hz terminal refresh rate. After this field has been changed, the terminal must be reset for the new refresh rate to be in effect. Reset can be done by turning the power off and then back on again.

Contrast Press the Cursor Up/Down key until the desired contrast is attained.

4.2.2 Set-Up Line B

To view the second set of parameters stored in the terminal's memory, press the SET UP key while pressing the SHIFT key. You should still be in LOCAL mode. This will be the second time you have performed the SHIFT/SET UP operation.

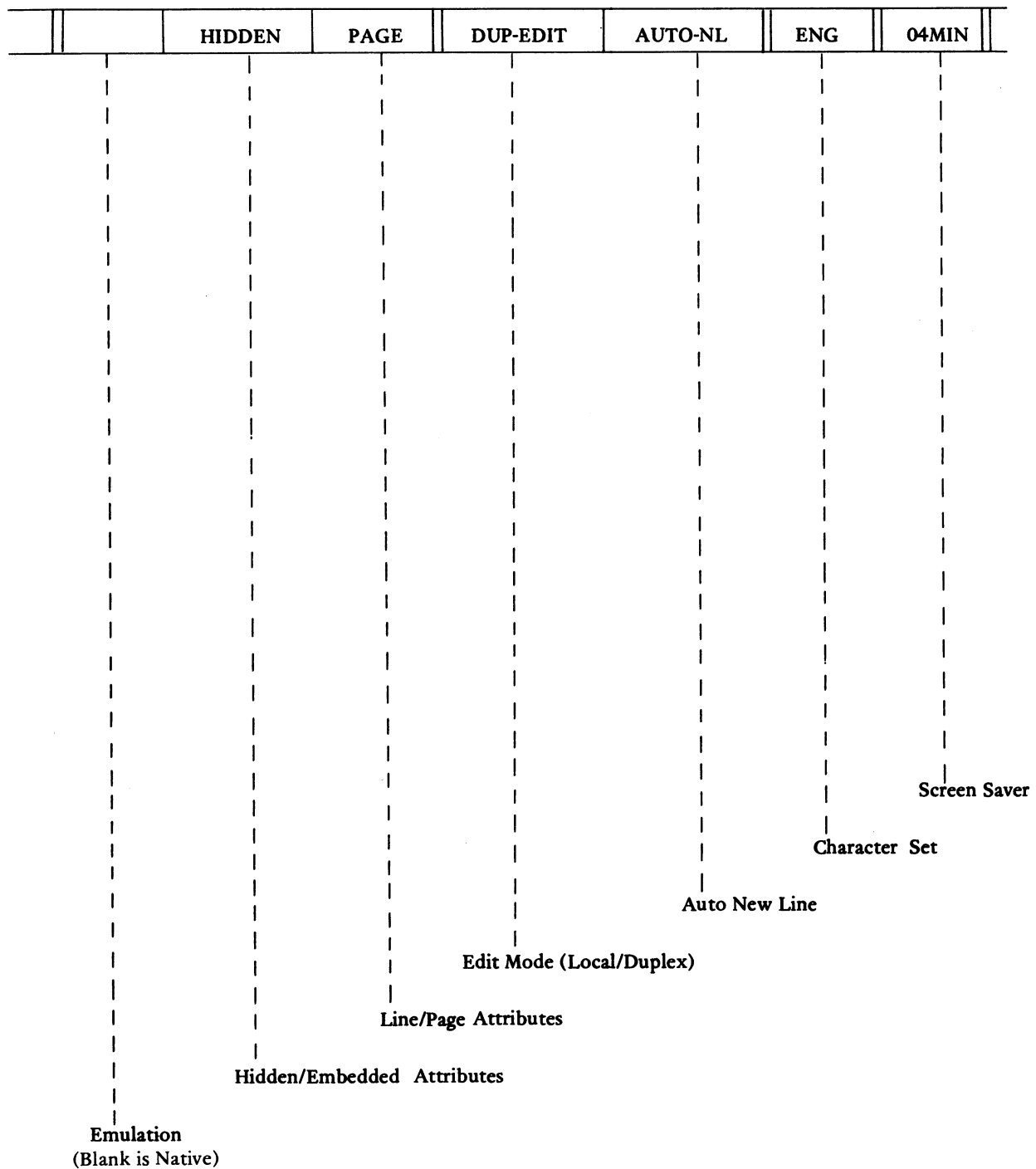

Figure 4-2: Set-Up Line B

To change the values established in the second page of the Set-Up Line, follow the procedure outlined in Section 4.2. For a description of the options available, refer to Table 4-5.

Table 4-5: Set-Up Line B: Options Available

| | |
|-----------------|--|
| Emulation | If the characters 920E appear in this field, your terminal is configured to emulate the TeleVideo Model 920 terminal. If this field is blank, the terminal is in its native mode and code-compatible with the TeleVideo Model 925. Escape and control code sequences for this emulation are also listed in Appendix A. |
| Hidden/Embedded | EMBEDD indicates that video attributes are embedded. This means that when video attributes are changed, a cursor space is taken on the screen for all video attributes except low intensity. If the word HIDDEN appears in this field, video attributes are hidden; that is, they do not occupy a cursor space. |
| Line/Page | If LINE is displayed, video attributes are enabled for the line on which the cursor is positioned. If PAGE is displayed, video attributes are enabled for the page in which the cursor is positioned. |

NOTE

Line/Page is in effect only when the Embedded attribute mode is selected.

| | |
|---------------|--|
| Edit Mode | If LOC-EDIT (Local Edit) is displayed, all cursor control keys (directional arrows and HOME) operate in Local mode only, regardless of the terminal communication mode. If DUP-EDIT (Duplex Edit) is displayed, the cursor control keys will operate in terminal communication mode like any other keys. |
| Auto New Line | If this function is enabled, the field will display the characters AUTO-NL. In this mode, the terminal will perform a CR and LF operation whenever data is entered on screen column 80. If disabled, the cursor will stay on column 80 until a cursor control code is received up, down, left or right arrow, CR, LF, etc. Data entered will be typed over column 80. |
| Character Set | Four different character sets are available: English, German, French and Spanish. |

NOTE

Control and ESC codes may vary, depending on the international character set selected. Refer to the proper CTRL and ESC code tables as you change from one character set to another.

| | |
|--------------------------------|--|
| Time Required for Screen Saver | To increase the life of the phosphor on your screen, you may opt to command the screen to go blank if the terminal does not receive any data within a specified amount of time. The digits displayed in this field (4, 8 or 16) specify the number of minutes required for the screen saver to be in effect. If this field is blank, the function is disabled. |
|--------------------------------|--|

NOTE

Data on the screen is safe as long as the terminal has not been turned off; data will not be lost as a result of the screen saver function.

4.3 Set-Up Checks

1. Once you have set the parameters to meet the requirements of your computer system, press the RETURN or SHIFT/SET-UP key. This will exit the Set-Up mode. The terminal should still be in LOCAL mode; the Status Line, User Line or blank 25th line should replace the Set-Up Line, depending on the 25th line mode set prior to entering Set-Up mode.
2. Press the SHIFT/LOCAL key on the keyboard. The Status Line will display the word "ON LINE."
3. Follow the log-on procedure required by your computer system. If you successfully log-on, you are ready to proceed to Section 6, Basic Operating Instructions.
4. If you are unsuccessful in your attempt to log on, one or more of the set-up values may have to be changed to meet the requirements of your computer system. Refer to the previous subsections for instructions, and instructions on your host computer system if necessary.

5. DATA COMMUNICATIONS AND TERMINAL INTERFACING

5.1 Overview

This section will provide information on each of the interfaces installed in the Model KT-7 terminal, the pin-outs, and communications modes available for use with your host computer system. A careful study of your system's specific requirements may be required to properly select the various parameters available to you.

5.2 Interfaces

Three separate interfaces are provided as a standard part of your terminal: Main Port (Data Communication interface), Auxiliary Port (generally a Printer Port interface), and a Keyboard Interface. Optionally, a Current Loop interface is available.

5.2.1 Main Port Interface

The standard 25 pin RS-232C connector (J1) located on the back of the terminal provides the connection to either the data set (modem) or the host computer directly. Pin connections for this interface are provided in Table 5-1.

Table 5-1: Pin Connections: Main Port Interface (J1)

| PIN NO. | EIA DESIGNATION | DIRECTION | DESCRIPTION |
|---------|--------------------|---------------|-------------------------------|
| 1 | AA | ----- | Protective Ground |
| 2 | BA | From Terminal | Transmit Data Output |
| 3 | BB | To Terminal | Receive Data Input |
| 4 | CA | From Terminal | Request to Send Output |
| 5 | CB | To Terminal | Clear to Send Input |
| 6 | CC | To Terminal | Data Set Ready Input |
| 7 | AB | ----- | Signal Ground |
| 8 | Not Used | | |
| 11 | Not Used | To Terminal | External Receive Clock |
| 12 | SCF (option) | To Terminal | Receive Current Loop + |
| 13 | SCB (option) | From Terminal | Transmit Current Loop - |
| 14 | SBA (option) | From Terminal | 20 mA Source -12V |
| 15 | DB (option) | From Terminal | 20mA Source +12V |
| 16 | SBB (option) | From Terminal | 20mA Source -12V |
| 17 | DD (option) | From Terminal | 20mA Source + 12V |
| 19 | Not Used | | |
| 20 | CD | From Terminal | Data Terminal Ready Output |
| 21 | Not Used | | |
| 24 | DA (option) | To Terminal | Receive Current Loop - |
| 25 | Not Used (option) | From Terminal | Transmit Current Loop + |

5.2.2 Auxiliary Port Interface (Printer Port)

This port is labeled AUX on the rear panel of the terminal. It provides an interface to an auxiliary device (generally a printer). Any RS-232C compatible serial printer equipped with X-On/X-Off or Busy/Ready protocol can be used. If your printer is equipped with Busy/Ready signal, connect Busy/Ready signal from the printer to Pin 20 (DSR Input) of the terminal. If Busy/Ready is not used, pin 20 must be left disconnected or held at positive EIA level.

The device connected to this interface must operate with a data rate, word structure and parity which is consistent with one of the terminal configurations available through the Set-Up mode (See Section 4.2). Refer to your printer manual for specific interface requirements.

Table 5-2: Pin Connections: Auxiliary Port Interface (J2)

| PIN NO. | EIA DESIGNATION | DIRECTION | DESCRIPTION |
|---------|-----------------|---------------|-----------------------------------|
| 1 | AA | ----- | Protective Ground |
| 2 | BB | To Terminal | Receive Data Input |
| 3 | BA | From Terminal | Transmit Data Output |
| 4 | CA | To Terminal | Clear to Send Input |
| 5 | CB | From Terminal | Request to Sent Output |
| 6 | CC | From Terminal | Data Terminal Ready Output |
| 7 | AB | ----- | Signal Ground |
| 8 | CF | From Terminal | Data Carrier Detect Output |
| 19 | Not Used | | |
| 20 | CD | To Terminal | Data Set Ready (Busy/Ready) Input |
| 21 | Not Used | | |
| 25 | Not Used | | |

5.2.3 Bidirectional Print

If a device is connected to the Auxiliary Port to communicate with the host, the "bidirectional" feature should be enabled. Enter:

CTRL/R

This code functionally connects the Main and Auxiliary Ports. A device such as a KSR (keyboard send/receive) printer will be able to communicate directly with the host, and the screen will continue to be updated. To disable this function, enter:

CTRL/T

5.2.4 Keyboard Interface

The six pin KB connector (J10) is provided on the rear panel of the terminal for keyboard connection. The pin assignments are as follows:

Table 5-3: Pin Assignments: Keyboard Interface (J10)

| PIN NO. | DESCRIPTION |
|---------|--------------------------|
| 1 | AC Ground |
| 2 | DC Ground |
| 3 | +12V |
| 4 | Busy (from keyboard) |
| 5 | Receive (to Keyboard) |
| 6 | Transmit (from Keyboard) |

5.3 Communications Modes

Duplex, parity, word structure, and baud rates affecting the transmission and receipt of data must be set to match the device to be used. These parameters are established in the Set-Up mode (see Section 4.2). Communications modes, however, are set by entering a specific escape code sequence while in the LOCAL mode.

5.3.1 Conversation Mode

ESC C or CTRL/F2 puts the terminal in Conversation mode. Each character or character sequence is transmitted to the host as it is keyed in. Conversation mode is active in either full or half duplex.

In Full Duplex mode (ESC } or CTRL/F4), data entered from the keyboard is sent directly to the computer system. The echo back from the host is required in this mode for the data to be displayed on the screen.

Half Duplex mode (ESC { or CTRL/F3). Data entered from the keyboard is sent directly to the computer system and is also treated as received data by the terminal. Echoing is not required by the terminal in this mode; if it is used, each character entered from the keyboard will be displayed twice on the screen.

5.3.2 Block Mode

ESC B or CTRL/F1 puts the terminal in Block mode. In this mode, each character or character sequence is stored in the data space of terminal memory until a command to transmit the data to the host is entered (see Table 6-3 for information on the "XMIT" key).

5.3.3 Local Mode

When "LOCAL" is displayed in the middle of the status line, the terminal is in LOCAL mode. Each character or character sequence is stored in the data space, just as in the Block mode, but communication with the host is disabled. Depressing the SHIFT/LOCAL key when it is in LOCAL mode will cause the terminal to return to an On-Line mode of operation.

5.4 X-On/X-Off Control

The Kimtron Model KT-7 video terminal has a 256-byte storage receive buffer. When the buffer is almost full (within 16 characters), the terminal will automatically send an X-Off code (DC 3/13H) to the host, requesting it to stop sending data. When the data in the receive buffer has been processed, the terminal transmits an X-On code (DC1/11H) to the host. This code requests that the computer resume sending data to the terminal.

Configuring the port for X-On/X-Off operation is done via the Set-Up Mode (see Section 4.2).

5.5 DTR Control

If DTR control is enabled and the terminal's receive buffer is filled, the Data Terminal Ready (DTR) line of the data communications port will go low. The DTR line will go high again once the terminal has processed all of the data stored in the receive buffer. DTR control is established via the Set-Up mode (See Section 4.2).

5.6 Software Reset

Your terminal can be reset to initial power-on state under terminal software control. To perform the Software Reset, type:

ESC CTRL /\

The software reset will cause the power-on default values to be restored.

6. BASIC OPERATING INSTRUCTIONS

6.1 General Information

Basic operating instructions include adjusting brightness, information on the keyboard layout and function of keys, how to use the Status and User Lines, and how to change initial set-up parameters. Instructions for turning the terminal on, and setting the terminal up for communication with the computer and auxiliary device have been discussed in previous sections.

6.2 Adjusting Brightness

If the intensity of the characters displayed on the screen appears too bright or too dim, use the BRIGHTNESS control knob on bottom front right corner of the terminal to adjust brightness. Contrast is adjusted through the Set-Up mode (see Section 4.2).

6.3 Keyboard Layout

Figure 6-1 illustrates the Kimtron Model KT-7 keyboard layout. The following subsection discusses each key's specific function(s) and the codes generated.

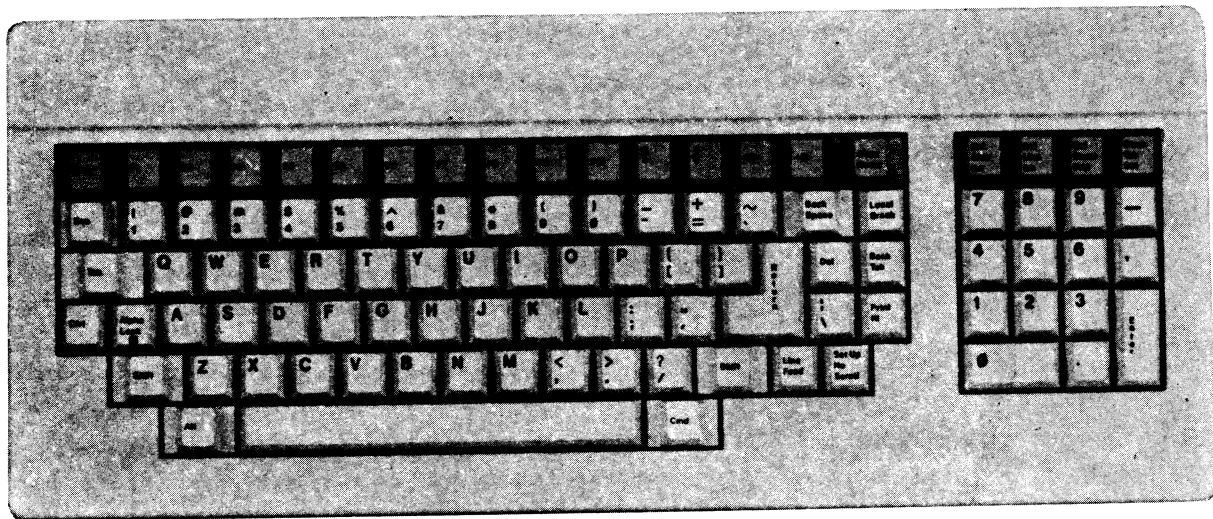

Figure 6-1: Kimtron Model KT-7 Keyboard Layout

6.4 Function of Keys

The Kimtron Model KT-7 video terminal keyboard is made up of seven types of keys, grouped according to their code generating functions:

1. Alphanumeric
2. Standard Control
3. Editing
4. Numeric
5. Communication
6. Device Control
7. Programmable Function

The following subsections discuss each of these groups in detail.

6.4.1 Alphanumeric Keys

There are 48 alphanumeric keys on the keyboard. They consist of:

- 26 alphabetic keys
- 10 combination numeric and symbol keys
- 11 dual symbol keys
- 1 space key

6.4.2 Standard Control Keys

These keys consist of the ESC, TAB, CTRL, ALPHA LOCK, SHIFT, BACK SPACE, DELETE, BACK TAB, RETURN and LINE FEED keys. Table 6-1 lists each key, the code generated, and the function performed.

Table 6-1. Standard Control Keys

| KEY | CODE GENERATED | FUNCTION |
|-------------------|----------------|---|
| ESCAPE (ESC) | ESC (1BH) | This code signifies the start of a multiple character command instruction. The terminal does not take any action until the full multiple character escape sequence command is entered and interpreted. Appendix A lists all of the available escape code sequences interpreted by the terminal. |
| TAB | CTRL/I (09H) | When this code is generated by the keyboard or host system, the cursor moves to the next tab stop position. If no tab stops are present, the cursor maintains its present position. |
| CONTROL (CTRL) | None | This key does not generate any output code by itself. When depressed in combination with certain other keys (see Appendix B), it causes control ASCII codes to be generated. |
| SHIFT | None | This key does not generate code by itself. When depressed in combination with certain other keys, it causes upper case code generation. |

| | | |
|-------------------|-----------------|--|
| BACK SPACE | CTRL/H (08H) | This code causes the cursor to move back (to the left) one character position on the current line (line on which the cursor is presently located). If the cursor is presently positioned at column 1, it will go to the last column of the previous line (same as cursor left). |
| DELETE | DEL (7FH) | This key generates the ASCII delete code. This key may be used to "rub out" previously entered characters. When received by the terminal, this character is ignored. |
| BACK TAB | ESC I (1BH-49H) | This key causes the cursor to move to the previous tab position. |
| RETURN | CTRL/M (0DH) | This key generates a CR code and performs a carriage return, or a CR and LF (carriage return and line feed) operation. It depends on whether or not the terminal is in the Auto LF mode. |
| LINE FEED (LF) | CTRL/J (0AH) | This key moves the cursor down one line in the same column without affecting the displayed data. When the cursor is in the last line, this code causes the terminal to scroll up one line. This only applies in the Conversation mode. In Block mode, the LF key will cause the cursor to move to the first line in the same column (see Section 5.3). |

6.4.3 Editing Keys

These keys control the direction of cursor movement (up, down, left, and right); position the cursor to HOME; insert characters and lines; delete characters and lines; erase lines and pages; and, in general, allow the user to edit any of the data entered on the screen. Tab Set/clear is also a function of one of the editing keys. Refer to Table 6-2 for a complete description of editing key functions and the codes generated by them.

Table 6-2. Editing Keys

| KEY | CODE GENERATED | FUNCTION |
|-------------------------------|----------------------------|--|
| CURSOR RIGHT (Right Arrow) | CTRL/L (0CH) | This key moves the cursor one position to the right. When the cursor is positioned in the last column, the cursor moves to the first column of the next line. When it is in the last column of the bottom line, the cursor moves to the Home position. |
| CURSOR LEFT (Left Arrow) | CTRL/H (08H) | This key moves the cursor one position to the left. When the cursor is positioned in the first column, it moves to the last column of the previous line. When the cursor is in the Home position, it moves to the last column of the bottom line. |
| CURSOR DOWN (Down Arrow) | CTRL/J (0AH) (920 Mode) | Same as Line Feed |

| | | |
|--------------------------------------|-----------------------------|--|
| | CTRL/V (16H) (KT-7 Mode) | This key moves the cursor down one line in the same column. If the cursor is at the bottom of the page, this key has no effect. |
| CURSOR UP (Up Arrow) | CTRL/K (0BH) (920 Mode) | This key moves the cursor up one line in the same column. When the cursor is positioned at the top of line of the page, it moves to the same column on the bottom line. |
| | CTRL/K (0BH) (KT-7 Mode) | Same as the 920 mode, except that it has no effect when the cursor is at the top line of the page. |
| HOME | CTRL/ ^ (1EH) | This key moves the cursor from any position on the screen to the first column of the top line. |
| INSERT CHARACTER | ESC Q (1BH-51H) | This key positions characters, starting at the current cursor location, to the right one character position. This enables a character (new) to be inserted at the cursor position. The last character of that line will be deleted. |
| DELETE CHARACTER (w/SHIFT key) | ESC W (1BH-57H) | This key replaces the character located in the cursor position with the character to its right. All characters following it are shifted one position to the left. |
| INSERT LINE | ESC E (1BH-45H) | This key causes the line containing the cursor and all lines below it to move down one line. All characters in the bottom line of the page are lost (deleted). The line on which the cursor is positioned is filled with spaces, allowing a new line of characters to be inserted. |
| DELETE LINE (w/SHIFT Key) | ESC R (1BH-52H) | This key causes the line on which the cursor is positioned to be replaced by the line below it. All lines following the deleted line are moved up one line. Spaces are inserted in the bottom line. |
| ERASE TO EOF (w/SHIFT key) | ESC T (1BH-54H) | This key causes the character in the cursor position and all characters to its right to be replaced by spaces. This command effects only characters located on the current line. The cursor does not move. "EOF" represents "End of Field". |
| ERASE TO EOP | ESC Y (1BH-59H) | This key causes the character in the cursor position and all characters following within the page to be replaced by spaces. Characters to the left of the cursor (on the current line) are not affected. The cursor does not move. "EOP" refers to "End of Page". |
| TAB SET | ESC 1 (1BH-31H) | This key establishes a tab setting for the column on which the cursor is positioned. This can be generated at any column on the screen, and causes tab stops to be set in the specified column for all lines. |

| | | |
|-------------------------------|--------------------|--|
| TAB CLEAR (w/SHIFT KEY) | ESC 2 (1BH-32H) | This key clears the tab set in the column on which the cursor is positioned. |
| TAB ALL CLEAR (w/CTRL KEY) | ESC 3 (1BH-33H) | This key clears all tab settings. |

6.4.4 Numeric Keys

The numeric pad is located to the right of the alphanumeric keys (main keyboard), and contains 14 keys: the digits 0 through 9, a decimal point, a comma, a minus symbol and an ENTER key. Each key generates the same character as the corresponding key on the main keyboard. The action of these keys is completely independent of the SHIFT, CTRL and ALPHA LOCK keys. The ENTER key corresponds to the RETURN key on the main keyboard.

6.4.5 Communications Keys

Communications protocol is discussed in Section 5, and the escape sequence codes required for setting the various modes are outlined. In this section, actual communications keys are discussed. Table 6-3 details the function of these three keys.

Table 6-3. Communications Keys

| KEY | CODE GENERATED | FUNCTION |
|----------------|---|--|
| XMIT | Normal: ESC 7(1BH-37H) Transmit Page | When this key is entered, all data on the page, from the HOME position to the current cursor position, will be transmitted to the host. |
| | Shift: ESC 5 (1BH-38H) Transmit Unprotected | When this key is pressed with the SHIFT key (or an ESC 5 is entered), all unprotected data on a page from the first column to the cursor position will be transmitted to the host. |
| LOCAL BREAK | Normal: None | This key generates a 250 millisecond break pulse to the host. |
| | Shift: None | When this key is pressed with the SHIFT key, the status line will display the word "ON LINE" or "LOCAL" |
| PRINT NL | Normal: 1FH | Auto-New line and Auto-line feed. |
| | Shift: ESC P (1BH-50H) Print Screen Formatted | When the PRINT key is pressed with the SHIFT key, all data on the screen including CR and LF codes at the end of each line are transmitted to the AUX Port. |

Table 6-3. Communications Keys (Contd.)

| KEY | CODE GENERATED | FUNCTION |
|-------------------|-----------------------------|--|
| | Control: ESC L (1BH-4CH) | When the PRINT key is pressed with the CTRL key, all unprotected data is sent to the printer. Protected fields are printed as spaces. Refer to Section 7.5 for a discussion of the Protect mode. |
| SET UP NO SCRL | NORMAL: None | When this key is pressed, the KT-7 stops screen updating. When pressed again, the KT-7 will start updating the screen. |
| | Shift; None | When this key is pressed with the SHIFT key, you can enter into or exit from SET-UP mode. Refer to Section 4.2 for a discussion of the SET-UP mode. |

6.4.6 Device Control Key

This key is labeled LOCAL and BREAK. In LOCAL mode, the terminal performs in the same manner as it does in the BLOCK mode (see Section 5.3.2), but communication with the host is not possible. To communicate with the host, depress the LOCAL key with SHIFT key again, the terminal will once again be On-Line. The Set Up key with SHIFT key enables you to go into SET-UP mode.

6.4.7 Programmable Function Keys

There are 20 (1 to 10 and shifted 1 to 10) programmable functions keys (PFK). A total of 256 bytes is provided for user-programming of these keys. Each PFK may be programmed with up to 25 characters.

6.5 Use of Status and User Lines

The Kimtron Model KT-7 video terminal reserves the 25th line of the screen for a status line. At power-on, the Status Line appears and provides useful information for the operator. Figure 6-2 illustrates a Status Line format.

NOTE

If the 25th line is enabled, LF function will require a longer time to process.

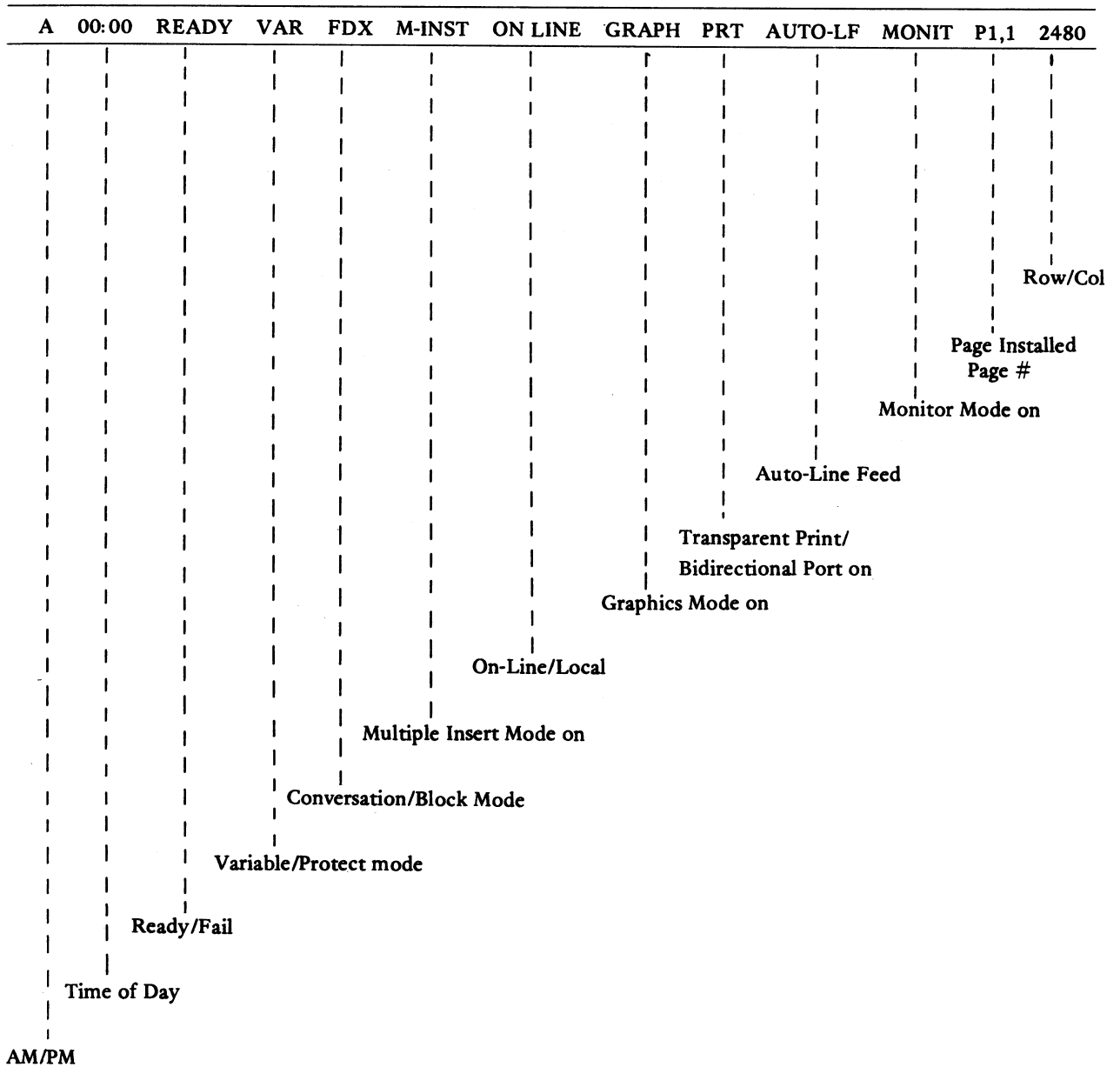

Figure 6-2: Status Line

6.5.1 Description of Status Line Fields

Table 6-4 lists and provides a description of each of the available fields displayed in the Status Line.

Table 6-4. Status Line Fields

| FIELD | DESCRIPTION |
|---------------------------|--|
| AM/PM | This field contains either the character A for AM, or P for PM, with reference to the time of day. |
| TIME OF DAY | This field contains the time of day in the format Hours: Minutes. See Section 7.12 for instructions on setting and sending the time of day. |
| READY/FAIL/KB LOCK | <p>READY indicates that the terminal is available for operator use. No error conditions have been detected, and the keyboard is unlocked.</p> <p>FAIL indicates that an error condition has been encountered.</p> <p>KB LOCK indicates that the keyboard is "locked". Receipt of the sequence ESC " from the host system will unlock the keyboard. When the keyboard is unlocked, "READY" will be displayed.</p> |
| VARIABLE/PROTECT | <p>VAR in this field indicates that the terminal is not in the Protect mode.</p> <p>PRO indicates that the terminal is in the Protect mode.</p> |
| FDX/HDX/BLK | <p>FDX indicates that the terminal is in Full Duplex Mode.</p> <p>HDX indicates that the terminal is in Half Duplex mode.</p> <p>BLK indicates that the terminal is in Block mode.</p> |
| ON LINE/LOCAL | The terminal automatically powers on in the ON LINE mode. Pressing the LOCAL/BREAK key with SHIFT key will cause this field to display the word LOCAL/BREAK and the terminal to operate in the LOCAL mode. |

Table 6-4. Status Line Fields (Contd.)

| FIELD | DESCRIPTION |
|------------------------|--|
| GRAPH | If these characters are displayed, the Graphics mode has been enabled. |
| PRT/P&D/BID | <p>PRT indicates that the terminal is in "Transparent Print" mode. In this mode, data from the host is transmitted to the printer port without displaying the data on the terminal screen.</p> <p>P&D is the same as PRT, except that the data are displayed on the terminal screen and transmitted to the printer port simultaneously.</p> <p>BID indicates the terminal is in "bidirectional" mode. In this mode, two way communication between terminal and auxiliary device is possible (see Section 5.2.3).</p> |
| AUTO-LF | If AUTO-LF is displayed, and the RETURN key is pressed, the cursor is moved to the first column of the next line. A line feed is performed automatically with a RETURN function. |
| MONITOR | If the characters MONIT are displayed, the Monitor mode has been enabled. In this mode, all characters entered on the keyboard or received from the host, including escape and control code sequences, are displayed on the screen but not acted upon (see Section 7.13). |
| PAGE 1/2/4 | "P", followed by a number, represents the number of pages the terminal has in memory. The single digit numeric indicates the page number where the cursor is located. |
| ROW/COL. | <p>The first two digits displayed in this field represent the row or line number on which the cursor is positioned.</p> <p>The last two digits in this field indicate the number of the column over which the cursor is positioned. Row and column indicators are always two digit decimal numbers.</p> |

6.5.2 Status Line Disable

To disable the display of the Status Line, enter:

ESC e

6.5.3 Description of the User Line

The 25th Line may be programmed to display user-supplied data, rather than the fields described in the previous section. To replace the Status Line with a User Line, follow the procedure outlined below.

1. Make sure the terminal is in LOCAL mode.
2. Type: ESC g
3. Type: ESC f
This will clear the User Line.
4. Enter the data you wish to be displayed in the User Line. A maximum of 80 characters is allowed.
5. To terminate the user message, enter a RETURN.

NOTE

If the User Line is filled with a total of 80 characters without a carriage return code, the cursor will automatically move to the previous screen cursor position. Host can send data as per steps 2 through 5 above.

6. To redisplay the Status Line, enter:

ESC h

6.6 Entering and Editing Data

6.6.1 General Information

Data (text) is entered via the keyboard and displayed on the screen. If the terminal is in Conversation mode, the terminal will transmit the corresponding ASCII code or code sequence to the host at the same time. In Local mode, the characters entered will simply be sent to the screen. A bell will sound when you approach column 72; this is a margin bell similar to that of a typewriter. You can change the column location at which the bell will sound (see Section 6.6.5). Setting and clearing tabs is also similar to those functions on a typewriter.

Editing or changing screen data is accomplished by moving the cursor to the location of the desired change, and then pressing the appropriate edit key (see Section 6.4.3.).

6.6.2 Moving the Cursor

As you type, the cursor will automatically move from left to right. When you reach column 80 (the end of a screen line), the cursor will advance to column 01 of the next line (if Auto New Line is enabled).

Five cursor control keys are located in the top row of the keyboard; four of them are marked with an arrow and the other is labeled HOME. To move the cursor to the top left position of the screen (Row/Line 01, Column 01), press the key marked HOME. To move the cursor in a different area of the screen, press one of the cursor control keys marked with an arrow. The cursor will move in the direction indicated on the keytop. Some software will not recognize the standard ASCII codes transmitted by the keys. In this case these keys will not function.

6.6.3 Editing Data

Edit keys and their corresponding codes are listed and discussed in Section 6.4.3, Table 6-2. Several additional codes are available for advanced editing applications, and are listed in Section 7.1, Table 7-1.

6.6.4 Setting and Clearing Tabs

Pressing the TAB key will cause the cursor to move to the location of the nearest tab stop (to the right). Screen tabs are set by positioning the cursor to the desired location for a tab stop, and then pressing the TAB SET/CLEAR key (located in the upper right corner of the keyboard). A tab will be set at this column on each screen line.

To clear a tab stop, position the cursor to the existing tab location. Press the SHIFT and TAB SET/CLEAR key. The tab stop will be cleared.

To clear ALL tab stops, enter:

CTRL/TAB CLR

Tab set/clear instructions may also be generated with escape code sequences:

| | |
|-------|--------------------------------------|
| ESC 1 | Set tab at current cursor position |
| ESC 2 | Clear tab at current cursor position |
| ESC 3 | Clear ALL tab stops |

6.6.5 Setting the Margin Bell

A bell will automatically sound when the cursor is positioned at column 72. If you would like the bell to sound at a different cursor position, move the cursor to the desired right margin and type the command:

ESC o

The command:

ESC n

disables the margin bell.

The margin Bell responds to data entered via keyboard only, and does not respond to data from the host.

7. ADVANCED OPERATING INSTRUCTIONS

7.1 Additional Editing Functions

Basic editing instructions are listed in Section 6.4.3, Editing Keys. There are several escape code sequences to enable more advanced editing tasks.

Table 7-1. Advanced Editing Commands

| CODE | FUNCTION | DESCRIPTION |
|-----------------|------------------------------------|--|
| ESC t | Erase to End-of-Line with Nulls | All characters from the cursor position to the end of the line or unprotected field are erased and replaced with null characters. If half intensity is on, the erased characters are replaced with half-intensity null characters (see Video Attributes, Section 7.4). NOTE: Null characters are displayed on the screen as spaces. |
| ESC y | Erase to End-of-Page with Nulls | All unprotected characters from the cursor position to the end of the page are erased and replaced with null characters. If half-intensity is on, the erased characters are replaced with half-intensity null characters. |
| ESC : | Clear Unprotected to Nulls | All unprotected data on the page is cleared to the null character (or half-intensity null characters if half-intensity is set). |
| ESC ; or CTRL/z | Clear Unprotected to Spaces | All unprotected data on the page is cleared to spaces. |
| ESC + | KT-7 MODE | Same as clear unprotected to spaces. |
| | TV 920 Mode | Clear all to spaces. |
| ESC , | Clear Page to Half-Intensity Space | All unprotected data on the page is cleared to half-intensity spaces. |
| ESC * | Clear All Data to Nulls | All data on the page is cleared to nulls. The Half Intensity and Protect modes are reset. |
| ESC F | Fill Screen with H Character | Fills the screen with H Character. |

7.2 Addressing the Cursor

By transmitting a four-character escape code sequence (see Table 7-2), the host can instruct the terminal to position the cursor in a specific location on the screen. This function is called "loading the cursor".

If your terminal has more than one page of memory, enter the command:

ESC - PRC

where **P** is the desired page, **R** is the desired row/line and **C** is the desired column. Values for **R** and **C** are listed in Table 7-2.

If your terminal has only one page of memory, enter the command:

ESC = RC

where **R** is the desired row/line on that page, and **C** is the desired column number. Values listed in Table 7-2 apply to single page terminals also.

7.3 Reading the Cursor

Entering the proper escape sequence will enable the computer to "read" the cursor's page, row and column position. Operators of single page terminals should enter:

ESC ?

Operators of multiple page terminals should enter:

ESC /

The terminal will respond by sending current page number, row/line number and column number. Page number is sent as a numeric ASCII character (e.g. "1" for Page 1). Row and column numbers are read as indicated in Table 7-2.

Table 7-2. Cursor Addressing Codes

| Value of R or C* | ASCII Code/ Keystroke | Value of C | ASCII Code/ Keystroke |
|------------------|-----------------------|------------|-----------------------|
| 1 | SPACE | | |
| 2 | ! | 41 | H |
| 3 | " | 42 | I |
| 4 | # | 43 | J |
| 5 | \$ | 44 | K |
| 6 | % | 45 | L |
| 7 | & | 46 | M |
| 8 | ' | 47 | N |
| 9 | (| 48 | O |
| 10 |) | 49 | P |
| 11 | * | 50 | Q |
| 12 | + | 51 | R |
| 13 | , | 52 | S |
| 14 | - | 53 | T |
| 15 | . | 54 | U |
| 16 | / | 55 | V |
| 17 | 0 | 56 | W |
| 18 | 1 | 57 | X |
| 19 | 2 | 58 | Y |
| 20 | 3 | 59 | Z |
| 21 | 4 | 60 | [|
| 22 | 5 | 61 | \ |
| 23 | 6 | 62 |] |
| 24 | 7 | 63 | ^ |
| 25 | 8 | 64 | _ |
| 26 | 9 | 65 | ` |
| 27 | : | 66 | a |
| 28 | ; | 67 | b |
| 29 | < | 68 | c |
| 30 | = | 69 | d |
| 31 | > | 70 | e |
| 32 | ? | 71 | f |
| 33 | @ | 72 | g |
| 34 | A | 73 | h |
| 35 | B | 74 | i |
| 36 | C | 75 | j |
| 37 | D | 76 | k |
| 38 | E | 77 | l |
| 39 | F | 78 | m |
| 40 | G | 79 | n |
| | | 80 | o |

7.4 Video Attributes

By controlling video attributes, the Kimtron Model KT-7 terminal can display characters with underline, reverse video, blink, blank or half-intensity, or any combination thereof (see Figure 7-1). Escape sequence commands to set or clear video attributes are shown in Table 7-3. Use the codes listed at the right hand side when the terminal is in 920 emulation mode.

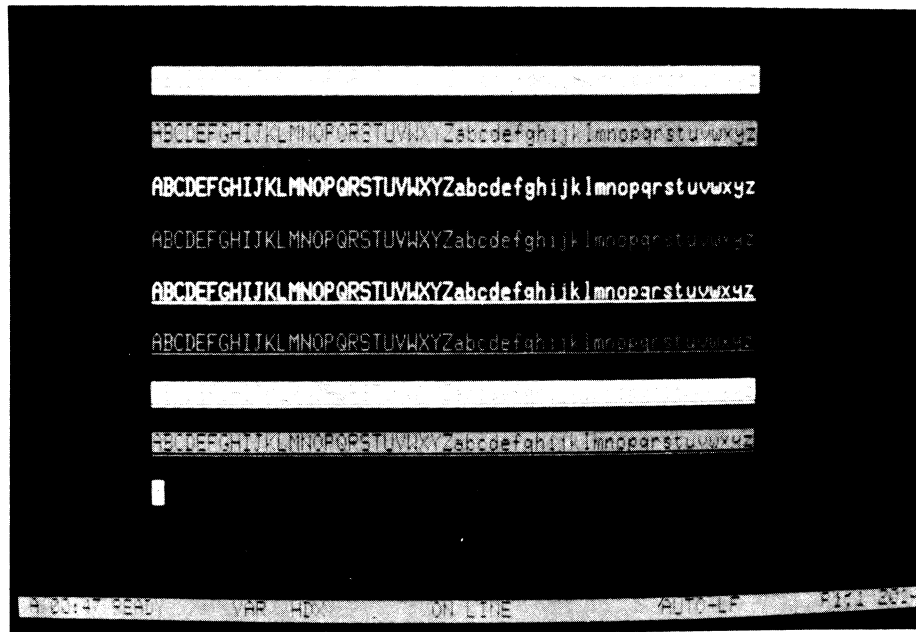

Figure 7-1: Kimtron Model KT-7 Video Attributes

Depending upon the parameters established in Field 2 of Set-Up Line B, all attributes other than half-intensity may be either embedded or hidden (half-intensity is always hidden).

If hidden attributes are selected, setting or clearing attributes will not require a character space on the screen. Also, if hidden attributes are selected, all attributes will be character attributes; that is, video attributes will be shown along with a character when a character is entered.

If embedded attributes are selected, setting or clearing all attributes, other than half-intensity, will require a character space on the screen to be occupied by an attribute character (attribute characters are displayed as blank spaces on the screen). Also, if embedded attributes are selected, all attributes other than half-intensity may be either line or page attributes, depending on the parameter selected in Field 3 of Set-Up Line B. If line attribute is selected, attributes will be visible as soon as they are activated from the activating position to the end of that line, or to the next attribute character, whichever is first. If page attribute is selected, attributes will be visible from the activating position to the end of the page, or to the next attribute character, whichever is first.

Table 7-3. Video Attribute Codes

| VIDEO ATTRIBUTE | MODEL KT-7 |
|--------------------------------------|-------------------|
| Invisible Screen Off (Normal Screen) | ESC G 0 |
| Invisible Screen On | ESC G 1 |
| Blinking On | ESC G 2 |
| Invisible Blink (End Blink) | ESC G 3 |
| Start Reverse Video | ESC G 4 |
| Invisible Reverse Video | ESC G 5 |
| Reverse Blink On | ESC G 6 |
| Invisible Reverse Blank | ESC G 7 |
| Underline On | ESC G 8 |
| Invisible Underline | ESC G 9 |
| Underline Blink On | ESC G : |
| Invisible Underline Blink | ESC G ; |
| Underline Reverse On | ESC G < |
| Invisible Underline Reverse | ESC G = |
| Underline Reverse Blink | ESC G > |
| Invisible Underline Reverse Blink | ESC G ? |
| Half Intensity On | ESC) |
| Half Intensity Off | ESC (|

7.5 Protect Mode

7.5.1 Overview

Enabling Protect mode allows designated areas (protected fields) on the screen to be protected from being altered or destroyed during future data entry sessions. An example of this would be the creation of a form on the screen (see Figure 7-2). The headings on this sample form should remain constant and should not be altered. If they are entered in the protect mode (as protected characters), it would not be possible for an operator to enter data over the protected text. A form can be set up to allow data entry in unprotected fields only.

All half-intensity fields (characters on the screen) are protected fields by definition when Protect mode is enabled. If Protect mode is enabled, the cursor is not allowed to enter the protected fields at all. It will instead pass over to the next available unprotected field. If the entire screen is protected, the cursor will go to HOME position and will not move.

PURCHASE ORDER

MANUAL 3
12 MONTGOMERY STREET
LOS GATOS, CA 95030

| QTY | ITEM | PART NO. | UNIT COST | EXTENSION |
|-----|------|----------|-----------|-----------|
| | | | | |

READY PRO HDN LOCAL AUTO-EP FINISH

Figure 7-2: Sample Form Created on the Kimtron Model KT-7

7.5.2 Procedure for Protecting Data

1. Position the cursor to the desired location of the first character.
2. Enter: ESC)
3. Enter the desired data.
4. Verify that each character entered is displayed at half-intensity.
5. Review the entry for accuracy and make any necessary changes.
6. Enter: ESC (
 - This will terminate half-intensity writing (protected writing).
7. Position the cursor to the next location to be protected and repeat the steps above.
8. Once the fields to be protected have all been entered, the screen is ready to be protected. This will prevent the cursor from entering any protected area unless Protect mode is disabled. Enter:

ESC &

9. To disable the Protect mode, enter:

ESC '

7.6 Transmitting Screen Data to the Host

Use of the XMIT key (discussed in Section 6.4.3) will enable the terminal to transmit a page or unprotected data on the screen to the host. The SHIFT/PRINT key will enable screen data transmission to the auxiliary device. Table 7-4 lists escape code sequences that enable various other means of data transmission.

Table 7-4. Data Transmission (To Host) Escape Codes

| CODE | FUNCTION | DESCRIPTION |
|-------------|-----------------------------|--|
| ESC 4 | Send Line Unprotected | All unprotected data on a line, from column 1 through the cursor position, will be sent to the host. Field delimiters instead of protected fields, and an end-of-text character at the end of data transmission are also sent to the host. |
| ESC 5 | Send Page Unprotected | Same as SHIFT XMIT Key (see Table 6-3). |
| ESC 6 | Send Line All | Sends the entire line on which the cursor is located. |
| ESC 7 | Send Page All | Same as XMIT key (see Table 6-3). |
| ESC S | Send Message Unprotected | All unprotected data on a page, bracketed by start of text (STX) and end of text (ETX), is sent to the host. If the page contains no STX and/or ETX codes, the Home position and end of page position will take their place, respectively. |
| ESC s | Send Message All | All data, including protected data between STX and ETX, is transmitted to the host. |

7.7 Communication with the Auxiliary Device

The data on the screen can be sent to the auxiliary device by using the SHIFT/PRINT key, as explained in Section 6.4.3. Table 7-5 explains the various communications functions with the auxiliary device.

Table 7-5. Communications Functions with the Auxiliary Device

| CODE | FUNCTION | DESCRIPTION |
|-------------|---|--|
| ESC P | Print Page All | Same as SHIFT/PRINT key (see Table 6-3). |
| ESC L | Print Page Unprotected | Same as CTRL/PRINT key (see Table 6-3). |
| ESC ' | Transparent Print (no video display) | All data received by terminal (including escape and control code characters) is output to the Auxiliary Port. When this mode is active, the screen is not updated. |

| | | |
|-----------------|---|--|
| ESC a | Transparent Print without display disabled | This code turns the transparent without display mode off. Data remaining in the terminal buffer will continue to be sent to the Auxiliary Port when the Printer buffer empties. This also turns off bidirectional print, or transparent w/o disp. |
| ESC @ | Transparent Print (with video display) | All data received by the terminal will be sent to the screen and the device connected to the Auxiliary Port. |
| CTRL/R | Bidirectional Print On | When the bidirectional port is enabled, data can be received from the auxiliary device. Data received from the auxiliary device will be treated the same as inputs from the keyboard. This feature allows an auxiliary device to communicate with the host directly, while displaying data on the KT-7 screen. |
| ESC A or CTRL/T | Transparent Print Off/ BID Port Off | This code turns off transparent print with display or BID port. |

For more information concerning data communications and terminal interfacing, refer to Section 5.

7.8 Selecting Block Mode Termination Character

Some host systems require line and/or transmit termination characters when utilizing the Block Mode. If this is the case, they may be programmed as follows:

ESC x 4NN for transmit termination and
ESC x 1NN for line termination

where NN are any two ASCII characters. The factory default value of these termination characters are:

Transmit termination character : CR, LF
Line termination character : US, NULL

7.9 Programming Function Keys (PFK)

As discussed in Section 6.4.7, the ten keys and the ten keys shifted on the keyboard may be programmed to perform user-specified functions; hence, the term "programmable function keys" (PFK). Up to 25 characters may be programmed on each function key, including function key number, duplex code, and termination character (CTRL/Y).

To program the PF keys, enter:

ESC | P1 P2 DATA CTRL/Y

where P1 is the number of the PF key, as listed in Table 7-6; P2 is the parameter for selecting mode, as listed in Table 7-7; DATA is the code specified by the user; CTRL/Y is the sequence entered to terminate the programming function. The HEX values for the escape sequence above are:

1BH 7CH P1 CODE P2 CODE code sequence to be programmed 19H

Table 7-6. Values of Parameter P1

| KEY | CODE ENTERED | KEY | CODE ENTERED |
|-----|--------------|-------------|--------------|
| F1 | 1 (31H) | F1 w/SHIFT | ! (21H) |
| F2 | 2 (32H) | F2 w/SHIFT | @ (40H) |
| F3 | 3 (33H) | F3 w/SHIFT | # (23H) |
| F4 | 4 (34H) | F4 w/SHIFT | \$ (24H) |
| F5 | 5 (35H) | F5 w/SHIFT | % (25H) |
| F6 | 6 (36H) | F6 w/SHIFT | ^ (5EH) |
| F7 | 7 (37H) | F7 w/SHIFT | & (26H) |
| F8 | 8 (38H) | F8 w/SHIFT | * (2AH) |
| F9 | 9 (39H) | F9 w/SHIFT | ((28H) |
| F10 | 0 (30H) | F10 w/SHIFT |) (29H) |

Table 7-7. Values of Parameter P2

| CODE | FUNCTION |
|---------|---|
| 1 (31H) | Full Duplex (Send to the host only) |
| 2 (32H) | Local (Send to the screen only) |
| 3 (33H) | Half Duplex (Send to the host and screen) |

To read the programmed functions, enter:

ESC M

This will display data stored in the function key buffer. A function key number will appear as a half-intensity character, followed by an ASCII character for P2, data sequence for that key, and finally CTRL/Y (EM). ASCII characters corresponding to function key numbers are as follows:

| | | |
|--------------------|----------------|-----|
| F1–F10 | Half-intensity | q-x |
| SHIFT/F1-SHIFT/F10 | Half-intensity | Q-X |

To clear the PF keys, enter:

ESC !

This will store 00H values in the PF key buffer.

7.10 Answerback

The Kimtron Model KT-7 terminal is equipped with an auto-answerback for modem or telex applications. When the terminal receives CTRL/E, it will respond by sending preprogrammed data to the data communications port.

To program the auto-answerback data, enter:

ESC] DATA (CR)

While data is being entered, it is displayed on the 25th line at the same time. The data to be programmed should not exceed 16 characters. Any character entered after the 16th character will replace the 16th character.

The 25th line is restored when the RETURN key is pressed.

7.11 Keyboard Lock/Unlock

The keyboard can be disabled by entering (or receiving from the host) the following code:

ESC #

Once the keyboard is locked (disabled), the keys are no longer functional. You must receive the following code from the host to enable (unlock) the keyboard:

ESC "

7.12 Time of Day Clock

Your terminal has a clock which will record and keep track of the time of day. The time is displayed in the first field of the Status Line in the following format:

A (AM) or P(PM) HR(Hour): MN (Minutes)

7.12.1 Set Time of Day

To set or change the time of day, enter:

ESC (Space) 1 X HR MN

where ESC is the ESC key, (Space) means pressing the space bar, 1 is the digit one, X is either A (for AM) or P (for PM), HR is the hour (two digits required), and MN is a two digit number to represent minutes. 8:15 in the morning would be entered as follows:

ESC (Space) 1 A 08 15

7.12.2 Send Time of Day

The computer can request the time of day by sending the following sequence to the terminal:

ESC (Space) 2

The terminal will respond with a five-character sequence (A or P, hours and minutes).

7.12.3 Print Time of Day

To send the time of day to the printer or auxiliary device, enter:

CTRL/SPACE BAR

7.13 Monitor Mode

The Monitor mode is useful in debugging programs. It enables the display of all 128 ASCII characters received from the host or entered from the keyboard, including escape and control code sequences (see Appendix A). Action is not taken on any of these codes; they are merely displayed on the screen. To enter the Monitor mode, type:

ESC U

To terminate the Monitor mode, type:

ESC u or ESC X

7.14 Graphics Mode

The terminal may be instructed to operate in a graphics mode. All characters entered from the keyboard or received from the host will be displayed as graphic symbols, rather than the characters indicated on the keytops. All ASCII characters except CTRL characters will be replaced by graphics characters in this mode (neither CTRL characters nor the Space Bar are affected). Table 7-8 lists the character conversion codes, and the visual attributes available in this mode. To enter the Graphics mode, type:

ESC \$ or CTRL/F9

To disable this mode and return to the normal character set, enter:

ESC % or CTRL/F10

7.15 Background

The operator has a choice between operating with a dark background (default condition) or a bright background. To implement the light background, in local mode, type:

ESC b

To return to a dark background, in local mode, type:

ESC d

Table 7-8. Graphics Mode Character Conversions

| | ø | 1 | 2 | 3 | 4 | 5 | 6 | 7 | | |
|---|----------|----------|---------|---------|---|---|---|---|----|-----|
| 0 | NL ° | DL ë | SP ! | SP ≤ | ø | @ | P | ∖ | ● | p |
| 1 | SH ı | D1 è | ! " | ≤ ≥ | 1 | A | Q | a | ↑ | q |
| 2 | SX ı̇ | D2 è | " # | ≥ ≪ | 2 | B | R | b | ↓ | r |
| 3 | EX £ | D3 é | # \$ | ≪ ≫ | 3 | C | S | c | ← | s |
| 4 | ET β | D4 ı̇ | \$ % | ≫ ⋈ | 4 | D | T | d | → | t |
| 5 | EQ Ñ | NK ı̇ | % & | ⋈ ⋉ | 5 | E | U | e | ı̇ | u |
| 6 | AK ñ | SY ı̇ | & ' | ⋉ ≅ | 6 | F | V | f | ı̇ | v |
| 7 | BL § | EB ı̇ | ' (| ≅ π | 7 | G | W | g | ı̇ | w |
| 8 | BS ç | CN ö | () | π θ | 8 | H | X | h | ı̇ | x |
| 9 | HT Ä | FM ö |) * | θ Ω | 9 | I | Y | i | ı̇ | y |
| A | LF Ö | SB ö | * Ω | Ω : | : | J | Z | j | ı̇ | z |
| B | VT Ü | EC ó | + α | α ; | ; | K | [| k | ı̇ | { |
| C | FF ä | FS ü | ' β | β < | < | L | \ | l | ı̇ | ı̇ |
| D | CR â | GS û | — Φ | Φ = | = | M |] | m | ı̇ | } |
| E | SO à | RS ù | · λ | λ > | > | N | ^ | n | ı̇ | ~ |
| F | SI á | US ú | / μ | μ ? | ? | O | — | o | ı̇ | DEL |

International Characters

Special Characters

Thin Line

Block

Thick Line

Black

7.16 Foreign Character Sets

International character sets for the English, German, French, and Spanish languages are available as a standard feature of the Kimtron KT-7 terminal. Anyone of the four sets may be selected via the setup mode. (Refer to Section 4.2.2). When the character set is changed, the KT-7 keyboard is automatically converted to the selected language layout. The Figure 7-3 through 7-5 show the layouts for each language mode. Seven bit character codes for all international characters are listed in Table 7-9.

In French mode, two diacritical marks, circumflex accent and umlaut mark, are available for character composition. These diacritical marks may be composed with vowel characters to display vowels with diacritical marks. For the character composition with diacritical marks, the following rules apply.

1. Display a vowel with a diacritical mark.
Enter a diacritical character followed by a vowel. When a valid vowel is entered, the corresponding composition character will be displayed at the cursor position and a two code sequence is transmitted to the host. The first code represents the vowel.
2. Display a diacritical mark only.
Enter diacritical mark character followed by a space character. When properly entered, the diacritical character is displayed by itself at the cursor position and only one code for the diacritical mark is transmitted to the host.
3. Cancel a diacritical mark.
If the character entered following a diacritical mark character is a non-vowel other than the space character, the diacritical mark is erased and the second character is displayed by itself. In this case, only one code for the character entered following the diacritical mark is transmitted to the host.

EXAMPLE: To display “â” on the screen, enter the following sequence:

- 1) Press the key labeled “^”.
- 2) Press “a”

The transmitted code sequence is 5EH followed by 61H.

Table 7-9: International Character Set

| ASCII | HEX | 23H | 24H | 40H | 5BH | 5CH | 5DH | 5EH | 60H | 7BH | 7CH | 7DH | 7EH |
|---------|--------|-----|-----|-----|-----|-----|-----|-----|-----|-----|-----|-----|-----|
| | SYMBOL | # | \$ | @ | [| \ |] | ^ | ‘ | { | | } | ~ |
| France | | £ | \$ | à | ° | ç | § | ^ | ‘ | é | ù | è | .. |
| Germany | | # | \$ | § | Ä | Ö | Ü | ^ | ‘ | ä | ö | ü | β |
| Spain | | # | \$ | @ | í | Ñ | ¿ | , | ‘ | ° | ñ | ç | ~ |

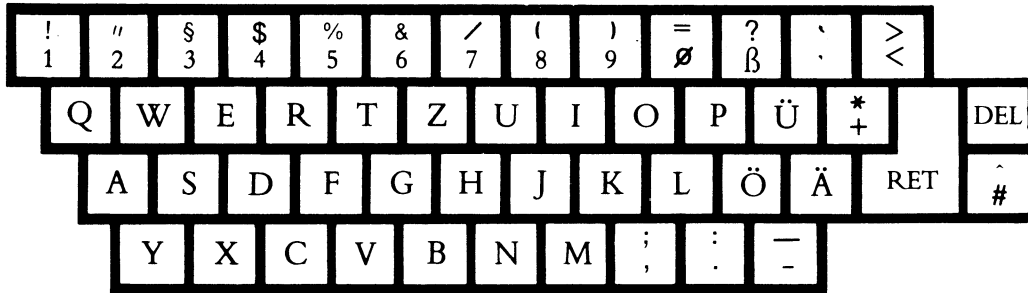

Figure 7-3. German Character Set: Keyboard Layout

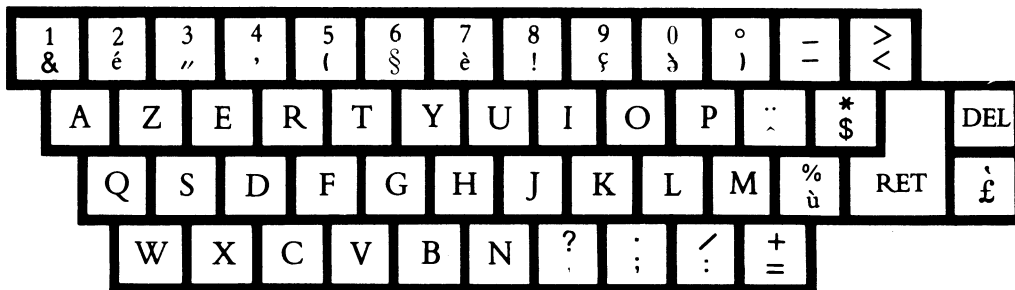

Figure 7-4. French Character Set: Keyboard Layout

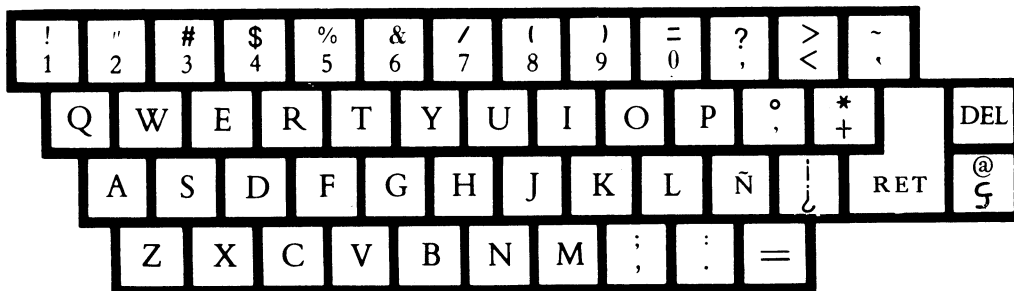

Figure 7-5. Spanish Character Set: Keyboard Layout

7.17 Keyboard Keyclick

If an audible "click" is desired whenever a key is depressed, this feature should be enabled. Enter:

ESC >

To silence the keyclick, enter: ESC <

7.18 Terminal Emulation

The standard Kimtron Model KT-7 terminal is code compatible with the TeleVideo Model 925. By setting Field 1 of Set-Up Line B, it can be enabled to emulate the TeleVideo Model 920. TeleVideo, Model 925 and 920, are trademarks of TeleVideo Systems, Inc.

8. OPTIONS

8.1 Amber Color Screen

An amber color screen is available as an option upon your request. Make certain "Amber Screen" is specified in your purchase order.

8.2 Additional Pages of Memory

A standard Kimtron Model KT-7 terminal is equipped with one page of memory. An additional three pages of memory may be added. A supplementary manual for a multi-page unit will be supplied.

8.3 Current Loop Interface

For those systems requiring a current loop interface, Kimtron may provide an addition 20mA current loop interface on the rear panel of the terminal. This interface converts the standard EIA RS-232C voltage level interface to a 20mA current flowing in the circuit; a spacing condition (logical 0) is no current flowing.

The terminal provides either a full or half duplex current loop interface. The terminal does not provide power for the current loop interface, so an external power source is required.

8.4 Expansion Capability

The Kimtron model KT-7 terminal is designed to be upgraded with additional capabilities by OEM's or system integrators. Added devices can be a built-in modem, processing capabilities, additional memory, and cards to emulate other terminals such as IBM 327X.

9. PREVENTIVE MAINTENANCE

Normal care should be taken with all computer equipment. Your terminal is no exception! Inspect and clean it periodically.

9.1 Cleaning the Terminal

Follow the steps outline below to properly clean your terminal.

1. Use a small brush or a soft brush vacuum attachment to clean and dust the keyboard. Do this every three months.
2. Dust the cabinet with a soft, lint-free cloth and a non-abrasive detergent if necessary. Do this every three months.

NOTE

Do not use solvent-based cleaners.

CAUTION

Do not pour detergent onto the terminal or spray the terminal. Put the detergent onto the cloth for cleaning.

9.2 Inspecting the Terminal

Once a year, inspect the terminal for the following conditions:

1. Crack or breaks in the cabinet.
2. Free movement of each key.
3. Cable damage.

9.3 Replacing the Battery

The Kimtron Model KT-7 uses a lithium battery, installed in a battery holder which is mounted on the terminal logic board. Its function is to back-up non-volatile memory in which set-up data are stored. The expected life of the battery can typically range from several months to as long as five years, depending on the way your terminal is used. If you observe changes in the stored set-up data, you may wish to replace the battery. Contact your supplier for a new battery, and then follow the procedure below to replace the battery:

1. Disconnect all cables.
2. Remove the four screws located on the rear of the main unit, and lift off the cover.
3. Disconnect all cables.
4. Gently slide out the logic board and replace the battery.
5. Slide the logic board back to its original location, reinstall connectors, and put the cover on.
6. Set up all non-volatile terminal parameters.

10. TROUBLESHOOTING GUIDE

10.1 General Information

It is important to remember that your terminal is a part of a total working system. All other parts (i.e. the host system, modem, interface cables, printer, etc) must be functioning properly for efficient input and output. Each part of the system should be checked out thoroughly before reporting a terminal malfunction to your service organization.

The terminal has a simple self-test program. If your terminal meets the test, the word READY will be displayed in the Status Line. If your terminal does not display READY in the Status Line, we suggest that you refer to the Troubleshooting Guide which follows.

Table 10-1 lists potential problems that may be encountered at the terminal, and suggests the probable cause (s) and solution (s). If you refer to this table and are unable to locate or resolve the problem detected, you should contact an authorized service agent.

10.2 Troubleshooting Guide

This guide provides some probable causes and suggests simple solutions. If this table does not enable you to resolve a terminal problem, contact an authorized service agent.

Table 10-1. Troubleshooting Guide

| PROBLEM | PROBABLE CAUSE | POSSIBLE SOLUTION |
|---|---------------------------------------|---|
| TERMINAL DEAD (No tone, no cursor) | No AC Power | Plug terminal in. Turn terminal on. Check voltage selector jumper on power P.C.A. |
| TERMINAL DEAD | Faulty or loose power supply fuses | Turn terminal power off and change fuses. |
| CURSOR WILL NOT APPEAR (terminal on; tone heard) | Light contrast setting | Toggle contrast setting in Set-Up Mode. Check brightness control volume. |
| | Blank Cursor | Type ESC .2 in LOCAL mode. |
| TERMINAL WILL NOT GO ON LINE | System not "up" | Verify system status. |
| | Loose, damaged or disconnected cables | Secure/connect cables. Check for cable damage. Check pins of J1 interface (see Section 5.2.1, Main Port Interface), |
| | Modem not on; faulty modem | Turn on modem; attach different modem to J1 port. |

Table 10-1: Troubleshooting Guide (Contd.)

| | | |
|---|--|--|
| | Position of phone handset reversed | Check position of handset. |
| TERMINAL ON-LINE; SYSTEM WON'T RESPOND | Parity, stop bit, word structure set incorrectly | Alter values in Set-Up Line. |
| TERMINAL DISPLAYS GARBAGE CHARACTERS | Incompatible baud rate/communications parameters | Verify system requirements; alter appropriate values in Set-Up Mode. |
| | Faulty modem | Replace modem. |
| | Static electricity | Check/treat area for static. |
| | AC outlet wired incorrectly | Check for proper grounding/wiring. |
| | Noisy phone lines | Check phone lines; install dedicated lines. |
| | EIA and AC cords intertwined | Keep power cord away from EIA cable to reduce noise on the data line. |
| TERMINAL DOESN'T DISPLAY CHARACTERS ENTERED WHILE ON-LINE | Incorrect duplex | Change duplex parameter. |
| INCORRECT DATA DISPLAYED SOME OF THE TIME | See above | See above. |
| FLICKERING/WAVY DISPLAY | Incorrect Refresh Rate setting | Alter Refresh parameter in Set-Up Mode. |
| ESCAPE/CONTROL SEQUENCES DO NOT FUNCTION PROPERLY | Incorrect use of escape/control sequences | Check terminal emulation value in Set-Up Mode; refer to Appendix B for proper codes. |
| | ALPHA LOCK key on | Depress key to enable lower case character generation. |
| | Wrong International Character Mode | Change international character mode in Set-Up Line B. |
| PRINTER DOES NOT PRINT WHEN COMMANDED | Incorrect command or key used | See Section 7.7. |

TABLE 10-1. Troubleshooting Guide(Contd.)

| | | |
|---------------------------------------|---|--|
| | Printer not on or plugged in | Turn printer power on; check printer power cord. |
| | EIA cable pin connections wrong | See Table 5-2. |
| GARBLED OUTPUT; TERMINAL LOSES MEMORY | AC outlet wired incorrectly | Check for proper grounding/wiring. |
| | Static Electricity | Check/treat area for static: <ul style="list-style-type: none"> – Install anti-static floor mats. – Use anti-static spray on carpeting in work area. – Increase the humidity. |
| KEYBOARD LOCKED | System not “up”; no communications link | Set duplex to HALF; try to enter data. If nothing appears, host must send ESC “. If data is displayed, check cables, modem phone lines; verify that system is up. Verify set-up parameters. |
| | Keyboard not connected to (J10) | Connect keyboard interface cable to main unit. |

NOTE

1. In order to replace the fuse, you should turn it counter-clockwisely pressing with a driver.
2. Power-switch on and off state.

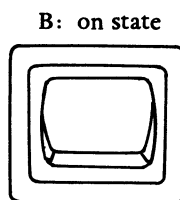
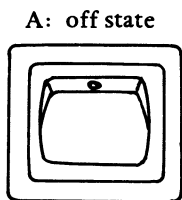

APPENDIX A

QUICK REFERENCE TO TERMINAL FUNCTIONS

| FUNCTION | 920E | KT-7 |
|--------------------------------|-------------------|-----------------------------|
| Bell | CTRL/G | CTRL/G |
| Cursor Left | CTRL/H | CTRL/H |
| Cursor Right | CTRL/L | CTRL/L |
| Cursor Down | CTRL/J | CTRL/V |
| Cursor Up | CTRL/K | CTRL/K |
| Cursor Home | CTRL/ ^ | CTRL/ ^ |
| Carriage Return | CTRL/M | CTRL/M |
| Linefeed | CTRL/J | CTRL/J |
| Newline | CTRL/- | CTRL/- |
| Tab | CTRL/ I | CTRL/ I |
| Address Cursor Page Row Column | ESC-P,R,C | ESC-P,R,C |
| Address Cursor Row Column | ESC =R,C | ESC =R,C |
| Read Cursor Page Row Column | ESC / | ESC / |
| Read Cursor Row Column | ESC ? | ESC ? |
| Back Tab | ESC I | ESC I |
| Set Column Tab | ESC 1 | ESC 1 |
| Clear Column TAb | ESC 2 | ESC 2 |
| Clear All Tabs | ESC 3 | ESC 3 |
| Field Tabs | ESC i | ESC i |
| Clear All to Nulls | ESC * | ESC * |
| Clear Unprotected to Spaces | ESC; or CTRL/Z | CTRL/Z or ESC + or ESC ; |
| Clear All to Half Intensity | | ESC , |
| Clear Unprotected to Null | ESC : | ESC : |
| Clear All to Space | ESC + | |
| Character Insert | ESC Q | ESC Q |
| Character Delete | ESC W | ESC W |
| Line Insert | ESC E | ESC E |
| Line Delete | ESC R | ESC R |
| Keyclick Enable | ESC > | ESC > |
| Keyclick Disable | ESC < | ESC < |
| End of Reverse Video | ESC k | ESC G0 |
| Reverse Video | ESC j | ESC G4 |
| Start Blink Field | ESC ^ | ESC G2 |
| Start Blank Field | ESC - | ESC G1 |
| End Blink/Blank | ESC q | ESC G0 |
| Start Underline | ESC 1 | ESC G8 |
| End Underline | ESC m | ESC G0 |
| Erase EOF with Spaces | ESC T | ESC T |
| Erase EOF with Nulls | ESC t | ESC t |
| Erase EOP with Spaces | ESC Y | ESC Y |
| Erase EOP with Nulls | ESC y | ESC y |
| Lock Keyboard | ESC # | ESC # |
| Unlock Keyboard | ESC " | ESC " |

QUICK REFERENCE TO TERMINAL FUNCTIONS (Contd.)

| | | |
|---|-------------|-------------|
| Full Duplex | ESC } | ESC } |
| Half Duplex | ESC { | ESC { |
| Protect Mode Enable | ESC & | ESC & |
| Protect Mode Disable | ESC ' | ESC ' |
| Write Protect (Half Intensity) Disable | ESC (| ESC (|
| Write Protect (Half Intensity) Enable | ESC) | ESC) |
| Block Mode Enable | ESC B | ESC B |
| Conversation Mode Enable | ESC C | ESC C |
| Blank Screen | | ESC O |
| Normal Screen | | ESC N |
| Send Line Unprotect Only | ESC 4 | ESC 4 |
| Send Page Unprotect Only | ESC 5 | ESC 5 |
| Send Line All | ESC 6 | ESC 6 |
| Send Page All | ESC 7 | ESC 7 |
| Send Message Unprotect Only | ESC S | ESC S |
| Send Message All | ESC s | ESC s |
| Monitor Mode Enable | ESC U | ESC U |
| Monitor Mode Disable | ESC u or X | ESC u or X |
| Enable Bidirectional Printer Mode | | CTRL/R |
| Disable Bidirectional Printer Mode | | CTRL/T |
| Enable X-On/X-Off | | CTRL/O |
| Disable X-On/X-Off | | CTRL/N |
| Transparent Print w/Display On | ESC @ | ESC @ |
| Transparent Print w/Display Off | ESC A | ESC A |
| Print (Page Print) | ESC P | ESC P |
| Transparent Print without Display Enable | | ESC ` |
| Transparent Print without Display Disable | | ESC a |
| Load User Line | ESC f text | ESC f text |
| Display User Line | ESC g | ESC g |
| Display Status Line | ESC h | ESC h |
| Reverse Linefeed | | ESC j |
| Set Local Edit Mode | | ESC k |
| Set Duplex Edit Mode | | ESC l |
| Set-Up Mode Enable | ESC z | ESC z |
| Select Transmit Termination Character | ESC x 4 NN | ESC x 4 NN |
| Select Line Termination Character | ESC x 1 NN | ESC x 1 NN |
| Set Cursor Attribute | ESC .n | ESC .n |
| Set Print Termination Character | ESC pn | ESC pn |
| Load Time | ESC sp 1 x | ESC sp 1 x |
| | HR MN | HR MN |
| Read Time | ESC sp 2 | ESC sp 2 |
| Program Function Key | ESC P1 P2 | ESC P1 P2 |
| | Data CTRL/Y | Data CTRL/Y |

QUICK REFERENCE TO TERMINAL FUNCTIONS (Contd.)

| FUNCTION | 920E | KT-7 |
|-------------------------------------|-------------|--------------------|
| Transmit Answerback | CTRL/E | CTRL/E |
| Terminal Software Reset | ESC CTRL/ \ | ESC CTRL/ \ |
| On Line | ESC CTRL/ ^ | ESC CTRL/ ^ |
| Local | ESC CTRL/ - | ESC CTRL/ - |
| Graphics Mode Enable | ESC \$ | ESC \$ or CTRL/F 9 |
| Graphics Mode Disable | ESC % | ESC % or CTRL/F 10 |
| Auto Line Enable | ESC 8 | ESC 8 |
| Auto Line Disable | ESC 9 | ESC 9 |
| Print Unprotected | ESC L | ESC L |
| Non-Display of 25th Line | ESC e | ESC e |
| Fill Screen with H Character | ESC F | ESC F |
| Multi-Character Insert Mode Enable | ESC Z | ESC Z |
| Multi-Character Insert Mode Disable | ESC r | ESC r |
| Margin Bell Set | ESC o | ESC o |
| Margin Bell Clear | ESC n | ESC n |
| Display PFK Content | ESC M | ESC M |
| Program Answerback | ESC] | ESC] |
| Dark Background | ESC d | ESC d |
| Bright Background | ESC b | ESC b |

APPENDIX B

CONTROL CHARACTER SYMBOLS

| KEY STROKE | ASCII CODE | SYMBOL |
|------------|------------|----------------|
| CTRL/@ | NULL (00H) | N _L |
| CTRL/A | SOH (01H) | S _H |
| CTRL/B | STX (02H) | S _X |
| CTRL/C | ETX (03H) | E _X |
| CTRL/D | EOT (04H) | E _T |
| CTRL/E | ENQ (05H) | E _Q |
| CTRL/F | ACK (06H) | A _K |
| CTRL/G | BEL (07H) | B _L |
| CTRL/H | BS (08H) | B _S |
| CTRL/I | HT (09H) | H _T |
| CTRL/J | LF (0AH) | L _F |
| CTRL/K | VT (0BH) | V _T |
| CTRL/L | FF (0CH) | F _F |
| CTRL/M | CR (0DH) | C _R |
| CTRL/N | SO (0EH) | S _O |
| CTRL/O | SI (0FH) | S _I |
| CTRL/P | DLE (10H) | D _L |
| CTRL/Q | DC1 (11H) | D ₁ |
| CTRL/R | DC2 (12H) | D ₂ |
| CTRL/S | DC3 (13H) | D ₃ |
| CTRL/T | DC4 (14H) | D ₄ |
| CTRL/U | NAK (15H) | N _K |
| CTRL/V | SYN (16H) | S _Y |
| CTRL/W | ETB (17H) | E _B |
| CTRL/X | CAN (18H) | C _N |
| CTRL/Y | EM (19H) | E _M |
| CTRL/Z | SUB (1AH) | S _B |
| CTRL/{ | ESC (1BH) | E _C |
| CTRL/ \ | FS (1CH) | F _S |
| CTRL/ } | GS (1DH) | G _S |
| CTRL/ ^ | RS (1EH) | R _S |
| CTRL/ _ | US (1FH) | U _S |

APPENDIX C

FILL CHARACTER REQUIREMENTS

| BAUD RATE | FUNCTION NUMBER | | | | |
|-----------|-----------------|----|-----|----|---|
| | I | II | III | IV | V |
| 19.2K | 60 | 4 | 20 | 4 | 4 |
| 9600 | 25 | 2 | 10 | 2 | 2 |
| 7200 | 18 | 1 | 7 | 1 | 1 |
| 4800 | 12 | 1 | 7 | | |
| 3600 | 9 | | 2 | | |
| 2400 | 6 | | 1 | | |
| 1800 | 4 | | | | |
| 1200 | 2 | | | | |
| 600 | 1 | | | | |
| 300 | | | | | |
| 150 | | | | | |
| 135 | | | | | |
| 110 | | | | | |
| 75 | | | | | |
| 50 | | | | | |

- Function I : Line Feed (LF) with 25 th Line
- Function II : Line Feed (LF) without 25th Line
- Function III : Erase Page (EOP), Clear Page, Fill Screen, Insert or Delete Line
- Function IV : Enable or Disable 25th Line
- Function V : Insert or Delete Character, Clear Function Key

APPENDIX D

USASCII CHART (CODES GENERATED FOR ENGLISH CHARACTER SET)

| b7 Bits b6 b5 b4 b3 b2 b1 | | | | | 0 | 0 | 0 | 0 | 1 | 1 | 1 | 1 |
|--|---|---|---|----|---------|----------------|----|---|---|---|---|------------|
| | | | | | 0 | 0 | 1 | 1 | 0 | 1 | 0 | 1 |
| Column | | | | | 0 | 1 | 2 | 3 | 4 | 5 | 6 | 7 |
| Row | | | | | 0 | 1 | 2 | 3 | 4 | 5 | 6 | 7 |
| 0 | 0 | 0 | 0 | 0 | NUL | DLE | SP | 0 | @ | P | | p |
| 0 | 0 | 0 | 1 | 1 | SOH | DC1 | ! | 1 | A | Q | a | q |
| 0 | 0 | 1 | 0 | 2 | STX | DC2 | " | 2 | B | R | b | r |
| 0 | 0 | 1 | 1 | 3 | ETX | DC3 | # | 3 | C | S | c | s |
| 0 | 1 | 0 | 0 | 4 | EOT | DC4 | \$ | 4 | D | T | d | t |
| 0 | 1 | 0 | 1 | 5 | ENQ | NAK | % | 5 | E | U | e | u |
| 0 | 1 | 1 | 0 | 6 | ACK | SYN | & | 6 | F | V | f | v |
| 0 | 1 | 1 | 1 | 7 | BEL | ETB | ' | 7 | G | W | g | w |
| 1 | 0 | 0 | 0 | 8 | BS ← | CAN | (| 8 | H | X | h | x |
| 1 | 0 | 0 | 1 | 9 | SKIP HT | EM |) | 9 | I | Y | i | y |
| 1 | 0 | 1 | 0 | 10 | LF | SUB | * | : | J | Z | j | z |
| 1 | 0 | 1 | 1 | 11 | VT ↑ | ESC | + | ; | K | [| K | { |
| 1 | 1 | 0 | 0 | 12 | FF → | ESC | , | < | L | \ | l | |
| 1 | 1 | 0 | 1 | 13 | CR | GS | - | = | M |] | m | } |
| 1 | 1 | 1 | 0 | 14 | SO | HOME RS | . | > | N | ^ | n | ~ |
| 1 | 1 | 1 | 1 | 15 | SI | NEW LINE US | / | ? | O | - | o | DEL RUB |

SUBJECT INDEX

A

- Alphanumeric Keys, 6-2
- Amber screen, 8-1
- Answerback
 - general information, 7-9
 - programming, 7-9
- Attributes
 - embedded, 7-4
 - hidden, 7-4
 - line, 7-4
 - page, 7-4
 - video, 2-1
- Auto Line Feed, 4-2
- Auxiliary Device Connection, 3-5
- Auxiliary Port Interface (Printer Port), 5-2

B

- Battery
 - general information, 10-1
 - replacement of, 9-1
- Bidirectional Print, 5-2
- Block Mode, 5-3
- Brightness, 6-1
- Brightness control, 3-5

C

- Character sets
 - foreign, 7-13
- Character
 - termination, 7-8
- Clock
 - time of day, 7-10
- Communications Keys, 6-5
- Communications characteristics, 2-2
- Connection
 - auxiliary device, 3-5
 - keyboard, 3-4
 - main port, 3-4
 - power supply, 3-5
- Conventions
 - ESC and CTRL, 1-2
- Conversation Mode, 5-3
- Conversation mode, 6-8
- Current Loop interface, 8-1
- Cursor Type, 4-1
- Cursor control keys, 6-10

Cursor

- addressing the, 7-2
- moving the, 6-10
- reading the, 7-2

D

- DTR protocol, 5-5
- Data
 - transmission to aux device, 7-7
 - transmission to host, 7-6
- Description of Status Line Fields, 6-7
- Description of the User Line, 6-10
- Device Control Key, 6-6
- Duplex Mode, 4-2

E

- Editing Data, 6-10
- Editing Keys, 6-3
- Embedded video attributes, 2-1
- Emulation
 - Teletype terminals, 7-13

F

- Full duplex, 4-2
- Function Keys
 - programming, 7-8
- Fuse rating, 3-4

G

- General Information, 6-10
- Graphics mode, 7-11

H

- Half duplex, 4-2

I

- Inspection
 - periodic, 9-1
 - receiving, 3-11
 - shipping damage, 3-3
- Interface, 5-1
 - auxiliary port, 5-2
 - current loop, 8-1
 - keyboard, 5-2
 - main port, 5-1
- Interfaces, 2-2

K

Keyboard Connection, 3-4

Keyboard Interface, 5-2

Keyclick, 7-13

Keys

Editing, 6-3

alphanumeric, 6-2

communication, 6-5

device control, 6-6

numeric, 6-5

programmable function, 6-6, 7-8

standard control, 6-2

L

Local Mode, 5-3

Local mode, 6-10

Lock

unlock keyboard, 7-10

Logic board, 9-1

M

Main Port Connection, 3-4

Main Port Interface, 5-1

Margin bell, 6-10

disable, 6-11

set, 6-11

Memory

additional pages, 8-1

Monitor mode, 2-1, 7-10

Moving the Cursor, 6-10

N

Non-embedded (Hidden) video Attributes, 2-1

Non-embedded (Hidden) video attributes, 2-1

Numeric Keys, 6-5

O

Overview, 7-4

P

Power Supply Connection, 3-5

Print Time of Day, 7-10

Procedure for Protecting Data, 7-6

Programmable Function Keys, 6-6

Programming

function keys, 7-8

Protect mode, 7-5

R

Requirements

physical, 3-1

power, 3-1

S

Screen saver, 4-7

Self-test, 10-1

Send Time of Day, 7-10

Set Time of Day, 7-10

Set-Up Line A, 4-3

Set-Up Line B, 4-6

Set-Up mode, 4-2

Setting and Clearing Tabs, 6-11

Setting the Margin Bell, 6-11

Standard Control Keys, 6-2

Status Line, 2-1, 3-5, 6-6

Status Line Disable, 6-9

Status Line

disable, 6-9

display of, 6-10

T

Tabs

setting and clearing, 6-11

Termination character, 7-8

Time

print, 7-10

send, 7-10

set, 7-10

Two-key rollover, 2-1

Typamatic, 2-1

U

User Line, 2-1, 6-6, 6-10

clear, 6-10

enable, 6-10

V

Video attributes, 2-1, 7-4,

Voltage selection, 3-3

X

X-On/X-Off protocol, 5-3