

# VT 220

---

## Installation Guide

1st Edition, August 1983

Copyright © 1983 by Digital Equipment Corporation. All Rights Reserved.  
Printed in U.S.A.

The reproduction of this material, in part or whole, is strictly prohibited. For copy information, contact the Educational Services Department, Digital Equipment Corporation, Maynard, Massachusetts 01754.

The information in this document is subject to change without notice. Digital Equipment Corporation assumes no responsibility for any errors that may appear in this document.

The following are trademarks of Digital Equipment Corporation, Maynard, Massachusetts.

**digital**  
DEC  
DECmate  
DECnet  
DECUS

DECwriter  
DIGITAL  
LA  
MASSBUS  
PDP

P/OS  
Professional  
Rainbow  
RSTS  
RSX

UNIBUS  
VAX  
VMS  
VT  
Work Processor

## **SITE PLANNING SPECIFICATIONS**

VIDEO TERMINAL WEIGHT      11.8 Kg (26 lbs.)

KEYBOARD WEIGHT              2 Kg (4.5 lbs.)

ELECTRICAL REQUIREMENTS    90 VAC to 128 VAC  
47 Hz to 63 Hz

OR

180 VAC to 268 VAC  
47 Hz to 63 Hz

## **OPERATING CONDITIONS**

RELATIVE HUMIDITY              10% to 90%

TEMPERATURE                    10 °C to 40°C  
(50° F to 104° F)



---

# VT220 INSTALLATION

## Unpack and check the contents of each carton

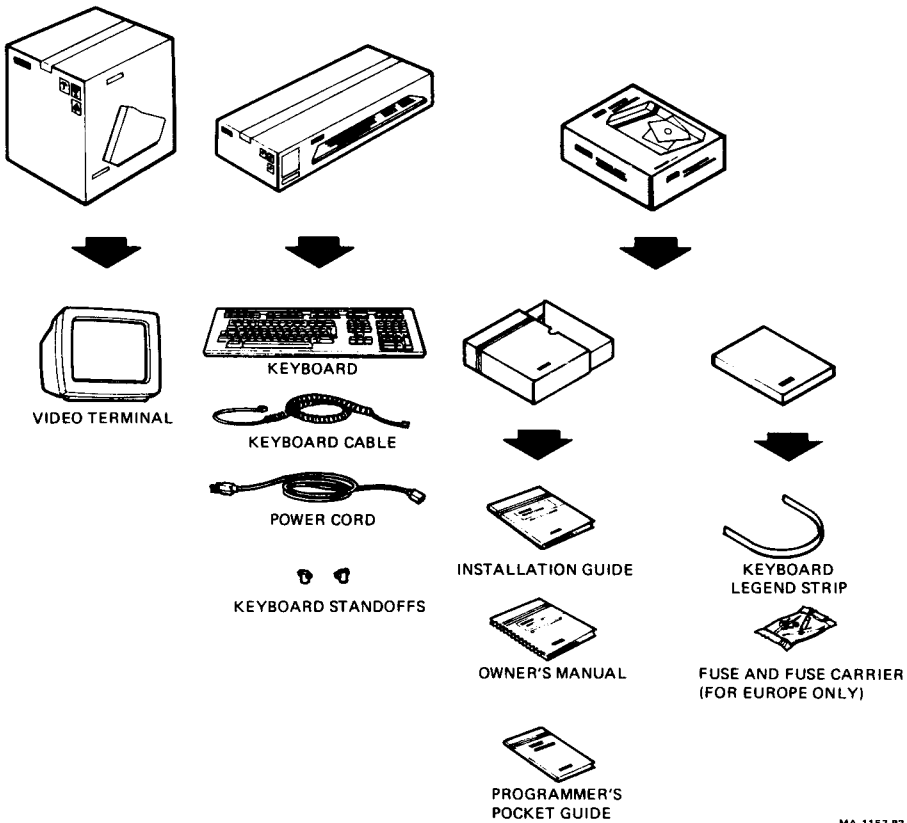

### MISSING ITEMS?

- Identify item(s)
- Contact your sales representative and delivery agent

### DAMAGE?

- Stop unpacking
- Contact your sales representative and delivery agent

# Identify connectors on rear panel of terminal

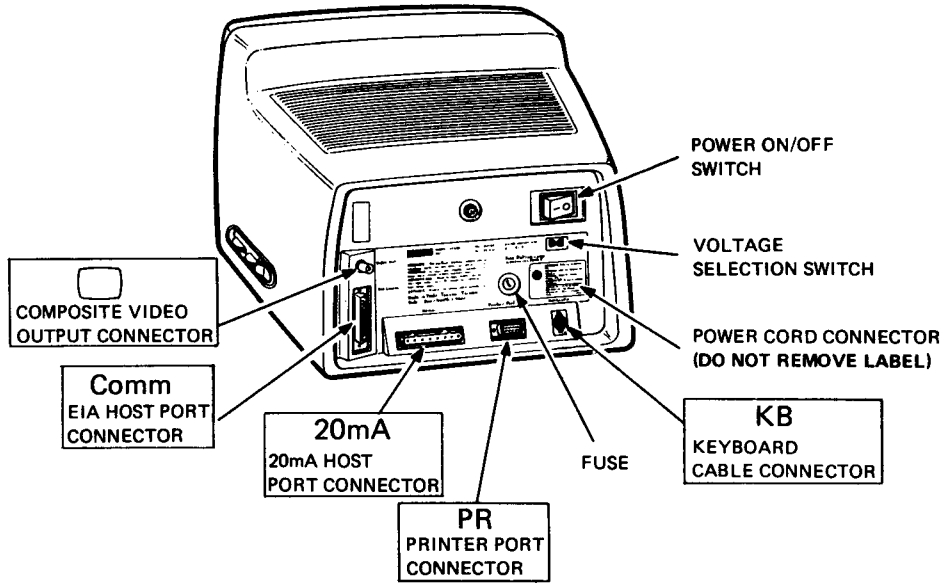

**Install legend strip**

1. Open clear plastic window.

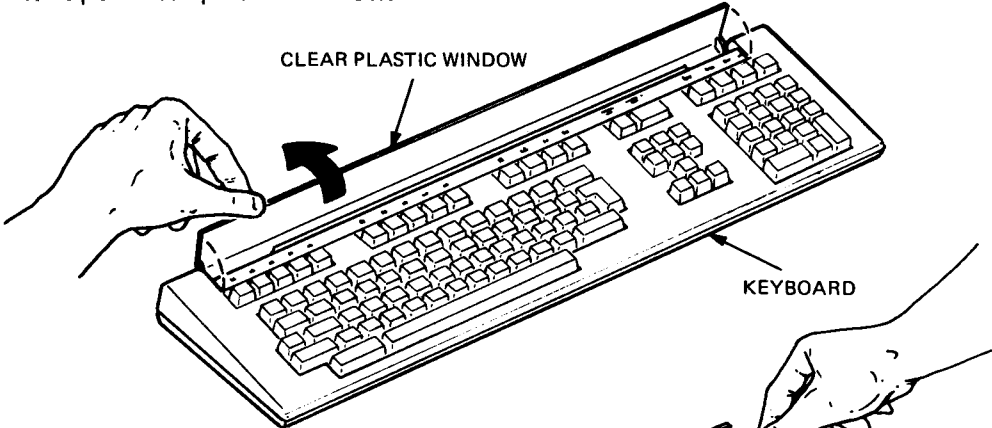

2. Insert new legend strip directly over the one presently on the keyboard.

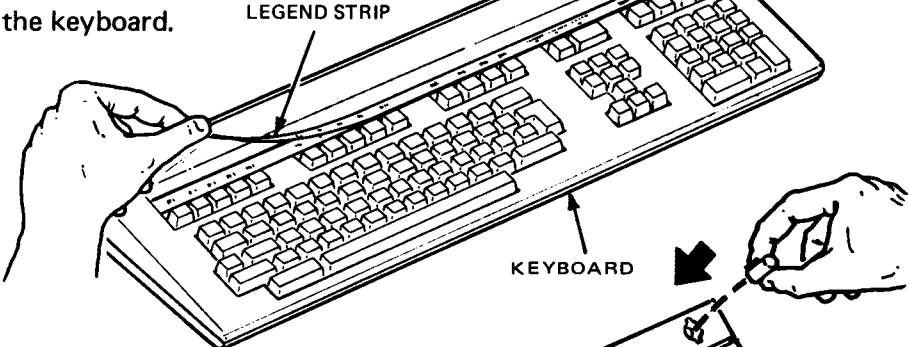

3. Close clear plastic window.

**Install keyboard standoffs.**

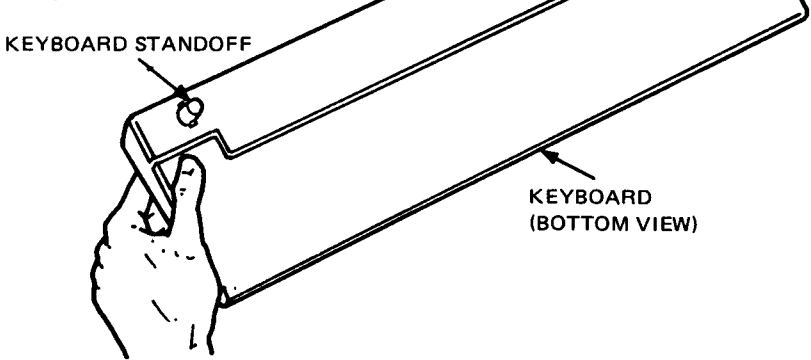



## Connect keyboard to video terminal

1. Insert longer end of keyboard cable into connector on bottom of keyboard.
2. Press cable into short groove of keyboard if routing to the left.
3. Press cable into long groove of keyboard if routing to the right.
4. Insert keyboard cable into connector on rear of terminal.

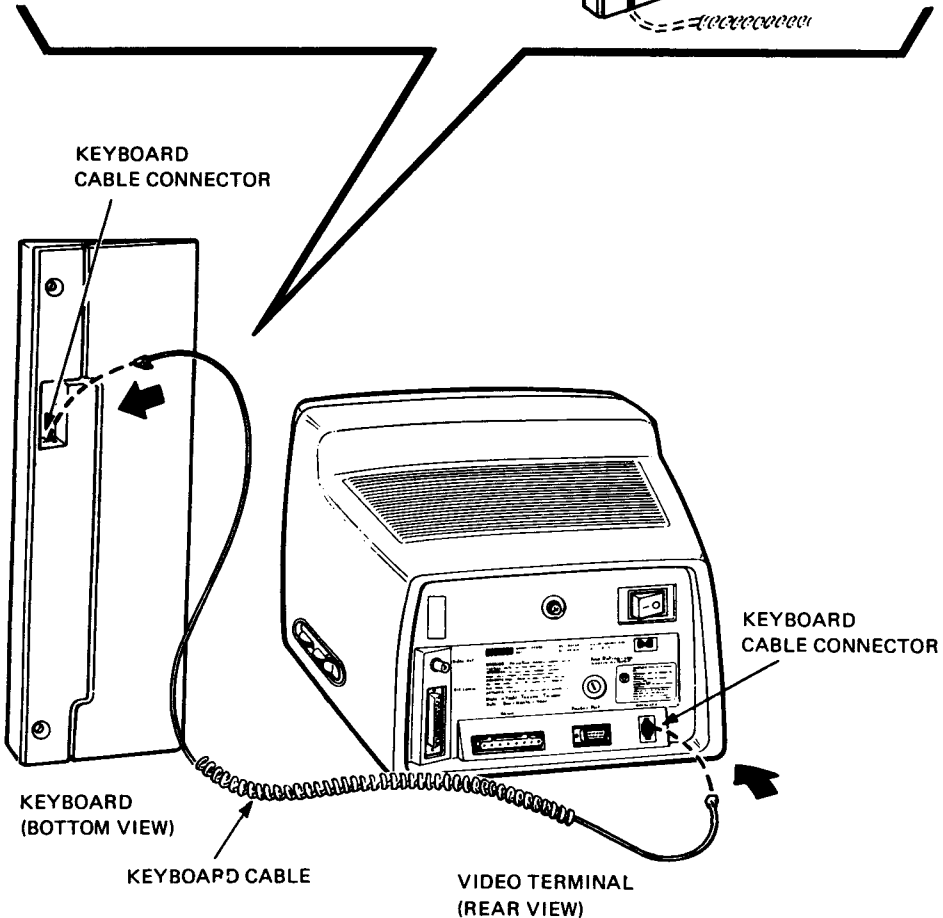
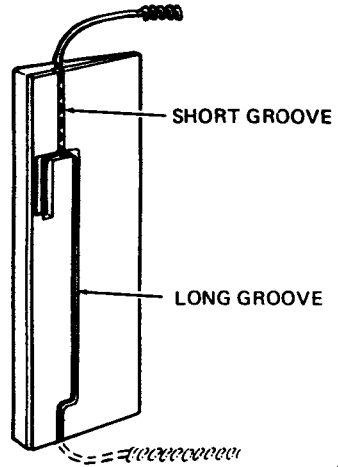

Match power cord to wall outlet voltage.

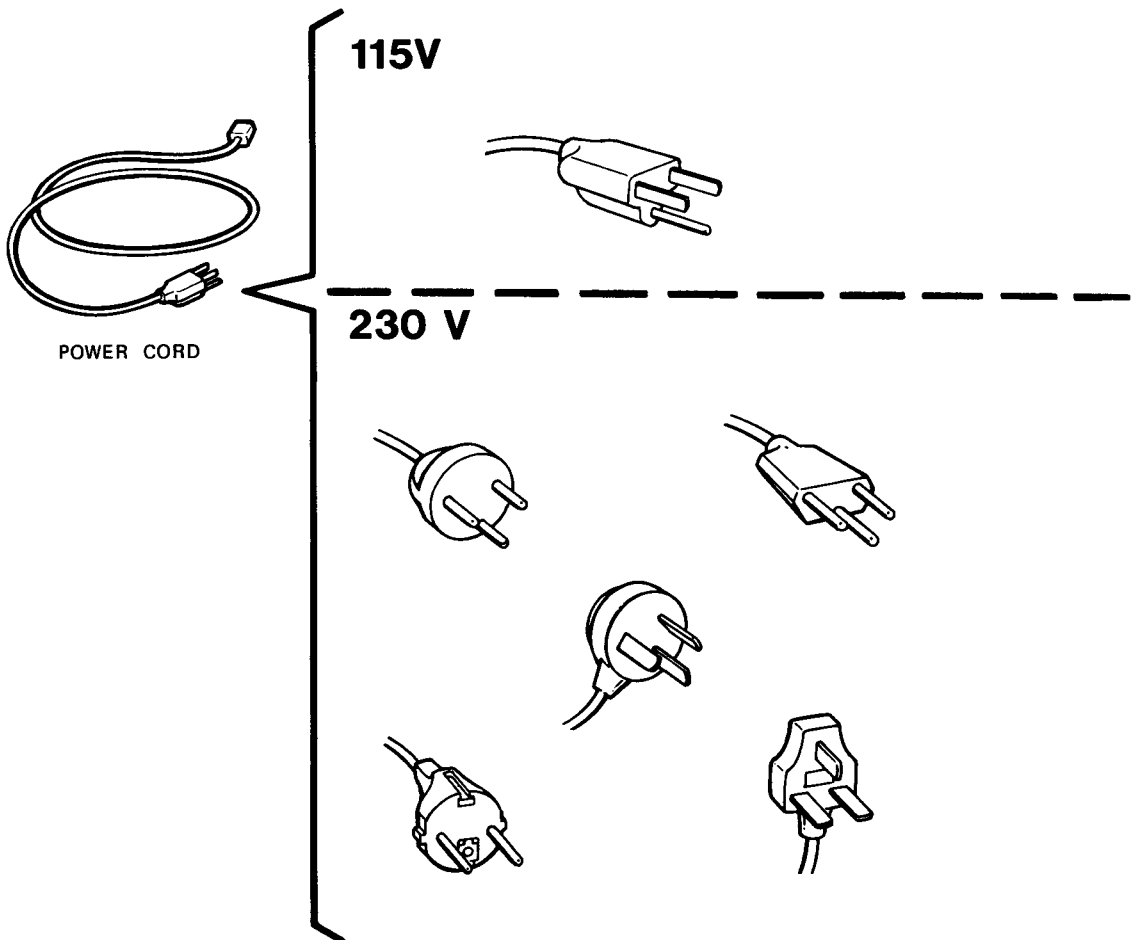

**Set voltage selection switch to match power cord voltage**

**CAUTION** Your terminal may be damaged if the voltage selection switch is set incorrectly. The voltage selection switch on your VT220 terminal was set to 115 volts by the manufacturer. If your input voltage is 230 volts, the voltage selection switch must be set to 230 volts, and both the fuse and fuse carrier must be replaced with the 230 volt parts provided.

**115V**

Make sure voltage selection switch is set to 115V.

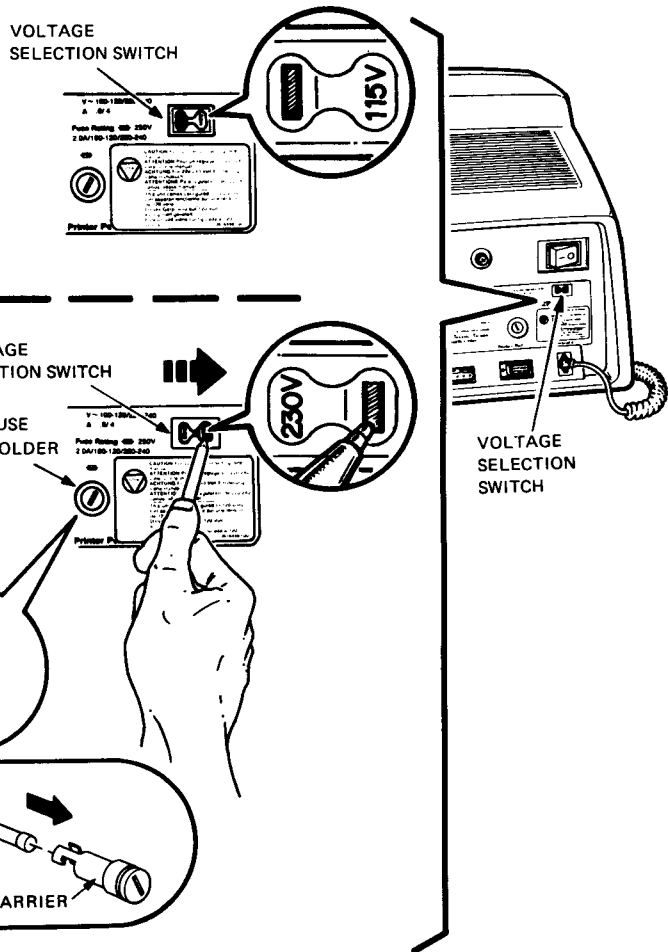

**230V**

Set voltage selection switch to 230V

Remove and replace fuse and fuse carrier with 230V replacement parts.

**Make sure the power switch is in the "O" (off position).**

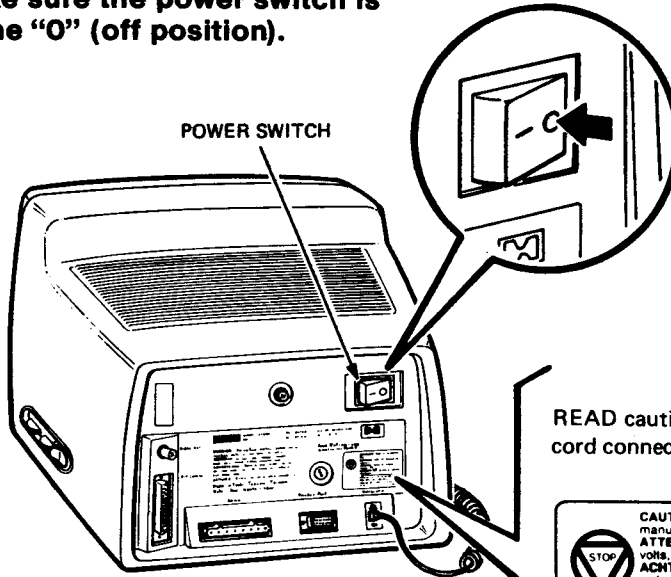

**READ caution label over power cord connector. Then remove label.**

 **CAUTION** For 220-240 volt setting, see manual.  
**ATTENTION** Pour un réglage sur 220-240 volts, voir le manuel.  
**ACHTUNG** Für 220-240 Volt Einstellung siehe Handbuch.  
**ATTENZIONE** Para regulación de 220-240 voltios, véase manual.

---

This unit comes configured to 120 volts  
Cet appareil fonctionne sur une tension de 120 volts  
Dieses Gerät wird auf 120 Volt konfiguriert geliefert  
Esta unidad viene configurada a 120 voltios

3616448-00

**Plug power cord into power cord connector on video terminal and into wall outlet**

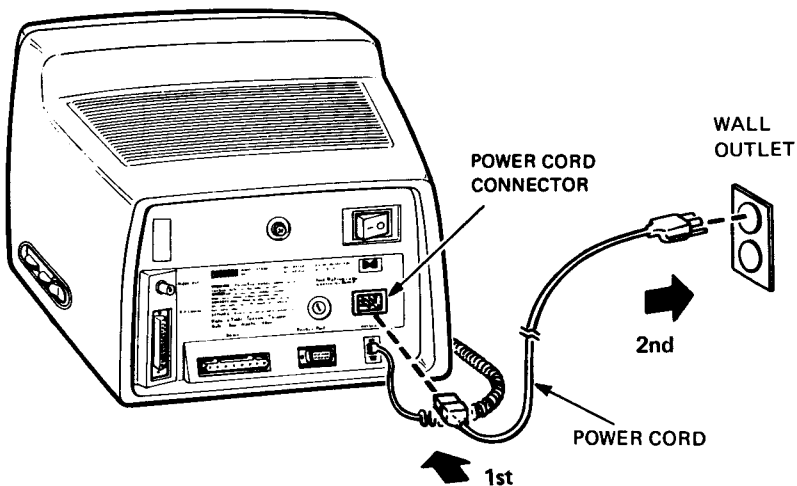

## Start up your terminal

1. Set the power switch to "1" (on position).

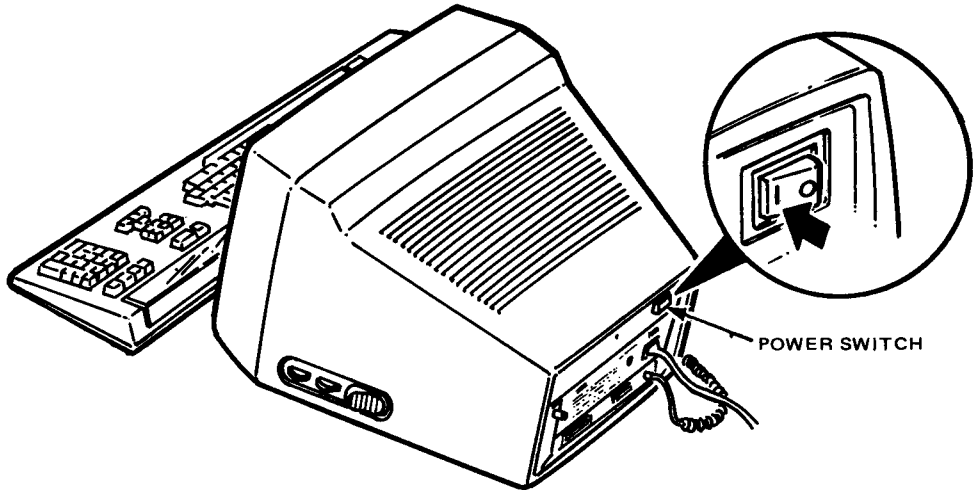

2. Make sure "Power OK" Indicator, the small green light on the front of your terminal, is on.

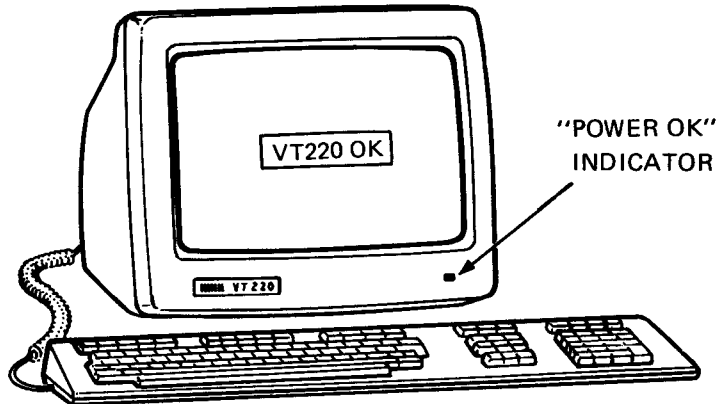

3. Listen for bell tone from keyboard.
4. Wait about 30 seconds for the display shown above to appear on the screen.

If you had problems, refer to page 14.

## Set brightness and contrast controls

1. Increase both the brightness and contrast to maximum.
2. Decrease the brightness until the white diagonal lines just disappear.
3. Decrease the contrast until the display relative to the screen background is of the desired intensity.

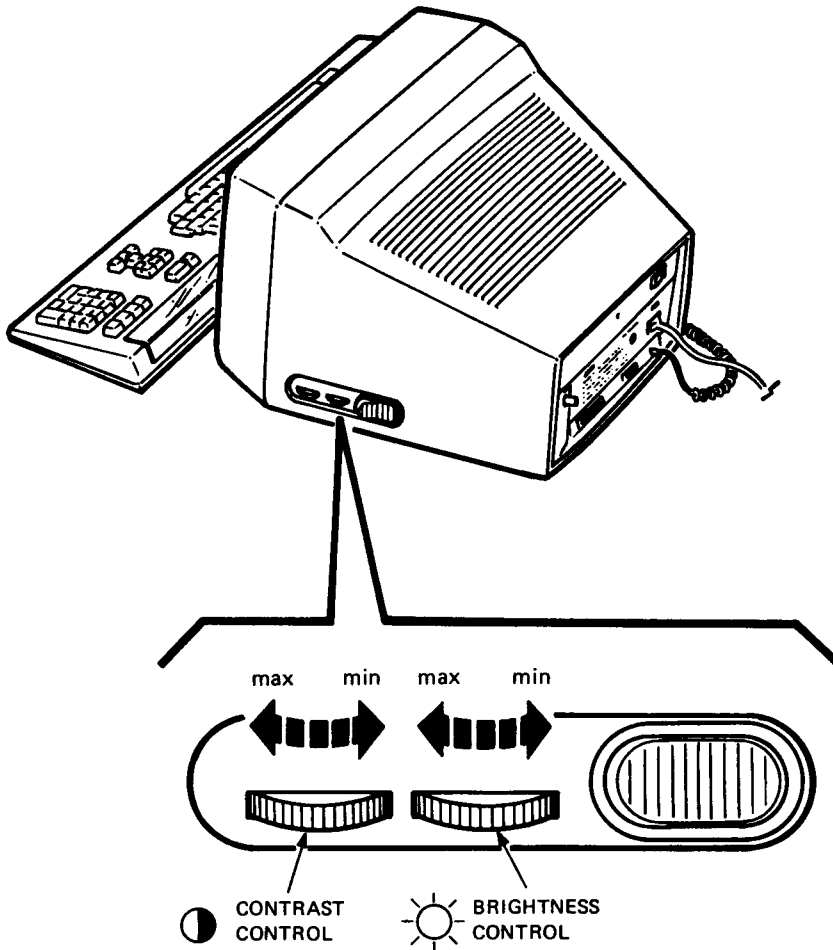

## Adjust viewing angle

With front of monitor resting on flat surface, raise rear of monitor until screen is at desired viewing angle. Press tilt leg release button to release tilt leg.

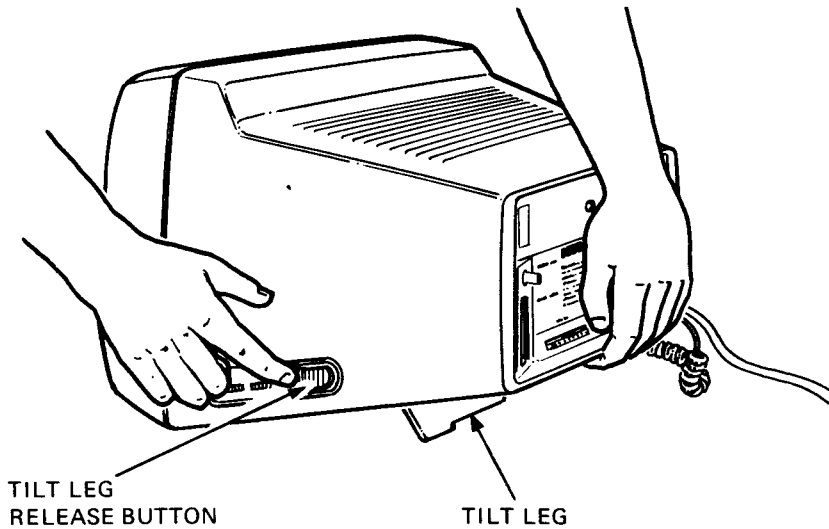

MA-0799-83

Refer to the following illustration for connecting the optional EIA, 20 mA, or printer cables to your terminal.

**CAUTION**

Set power switch to "O" (off position) before connecting cables.

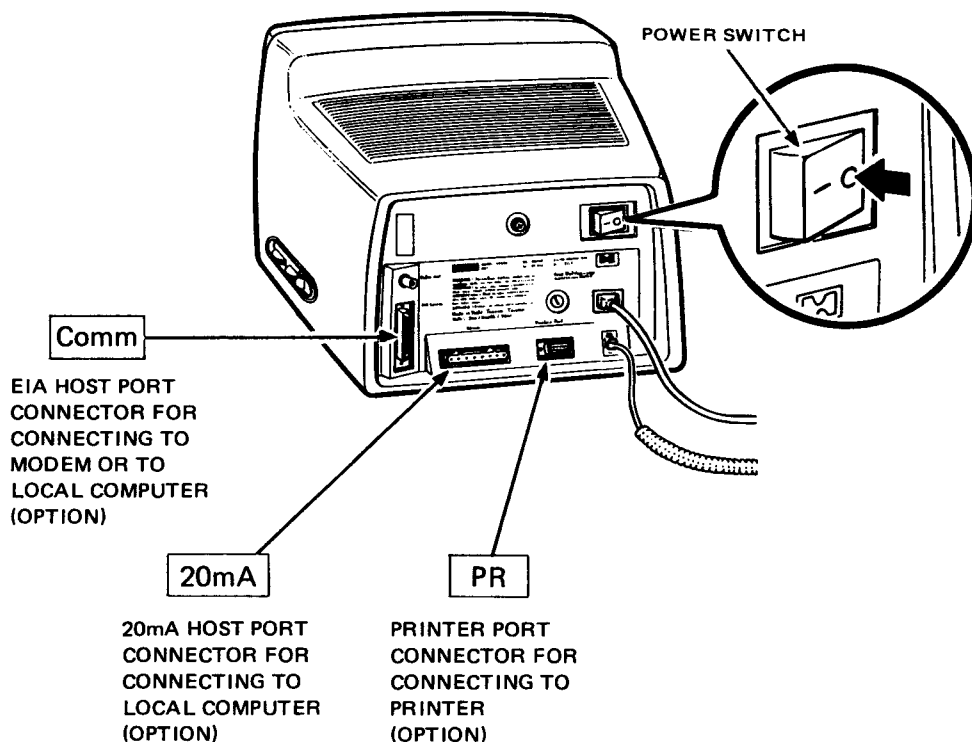

Set power switch to "1" (on position) after connecting cables.



## **CONGRATULATIONS**

**You have installed your video terminal successfully.  
Refer to your Owner's Manual for information that  
will get you started on your new VT220 terminal.**

## PROBLEMS?

Problem	Corrective Action
"Power OK" indicator is off	Check wall outlet. Make sure power cord connections are secure. Check fuse.
"Power OK" indicator on	Adjust brightness and contrast until "VT220 OK" appears on screen. (See page 10)
Keyboard bell tone heard	
No screen display	
Other	Call Digital Service Information (800)-DEC-8000