

Systems

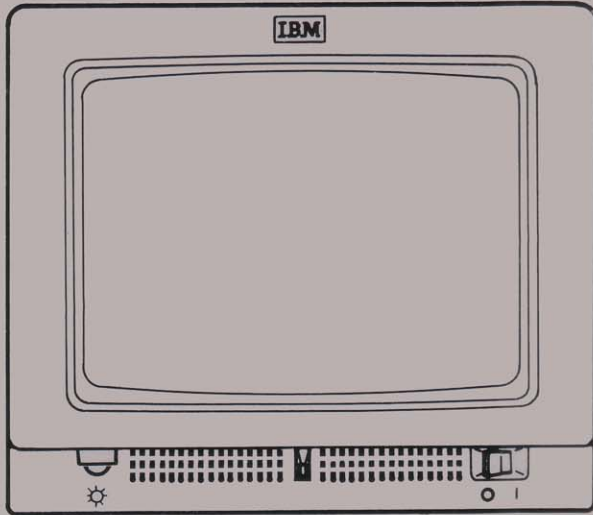

IBM 3164 ASCII Color Display Station Description

GA18-2317-1
File No. S370/303X/308X/309X/4300/8100/S1-09

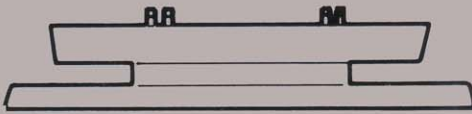

The IBM logo, consisting of the letters 'IBM' in a stylized, bold, sans-serif font with horizontal lines through the letters.

GA18-2317-1

File No. S370/303X/308X/309X/4300/8100/S1-09

Systems

**IBM 3164 ASCII
Color Display Station
Description**

IBM

Federal Communications Commission (FCC) Statement

Warning: This equipment generates, uses, and can radiate radio frequency energy and if not installed and used in accordance with the instruction manual, may cause interference to radio communications. It has been tested and found to comply with the limits for a Class A computing device pursuant to Subpart J of Part 15 of FCC Rules, which are designed to provide reasonable protection against such interference when operated in a commercial environment. Operation of this equipment in a residential area is likely to cause interference in which case the user at his own expense will be required to take whatever measures may be required to correct the interference.

The above FCC statement applies only to those machines used in the U.S.

First Edition (January 1986)

Changes are made periodically to the information herein; any such changes will be reported in subsequent revisions or Technical Newsletters.

References in this publication to IBM products, programs, or services do not imply that IBM intends to make these available in all countries in which IBM operates. Any reference to an IBM program product in this publication is not intended to state or imply that only IBM's program product may be used. Any functionally equivalent program may be used instead.

Publications are not stocked at the address given below. Requests for IBM publications should be made to your IBM representative or to the IBM branch office serving your locality.

A form for readers' comments is provided at the back of this publication. If the form has been removed, comments may be addressed to IBM Corporation, Publications Development, Department 6R1 J, 180 Kost Road, Mechanicsburg, PA 17055 U.S.A. IBM may use or distribute whatever information you supply in any way it believes appropriate without incurring any obligation to you.

International Business Machines Corporation

Armonk, New York 10504

Exhibit

IBM 3164 ASCII Color Display Terminal Limited Warranty

IF YOU PURCHASED THE IBM 3164 ASCII COLOR DISPLAY STATION (MACHINE) DIRECTLY FROM INTERNATIONAL BUSINESS MACHINES CORPORATION (IBM), OR ANOTHER IBM ORGANIZATION, UNDER AN AGREEMENT FOR PURCHASE OF IBM MACHINES OR FROM AN IBM APPROVED REMARKETER UNDER THE REMARKETER AGREEMENT FOR IBM PRODUCTS, THE WARRANTY PROVISIONS THEREIN SHALL PREVAIL AND THIS EXHIBIT AND THE ENCLOSED STATEMENT OF LIMITED WARRANTY SHALL NOT APPLY.

WARRANTY SERVICE DESCRIBED IN THE ENCLOSED STATEMENT OF LIMITED WARRANTY IS AVAILABLE ONLY FOR MACHINES PURCHASED AND LOCATED IN THE UNITED STATES OR PUERTO RICO.

IF YOU PURCHASED THIS MACHINE FROM A SUPPLIER AUTHORIZED BY AN IBM ORGANIZATION TO MARKET THIS MACHINE IN OTHER THAN THE UNITED STATES OR PUERTO RICO, WARRANTY INFORMATION IS AVAILABLE ONLY FROM SUCH SUPPLIER.

I. Date of Installation (Warranty Start Date):

The Date of Installation, which is the start date, will be the day (Monday through Friday) following the date of delivery of the Machine to you from an IBM Authorized Distributor or a Reseller who purchased the Machine from such Distributor, as applicable. Delivery is deemed to be complete when the Machine is placed in your possession; however, when the Machine is shipped to you, delivery will be deemed to be complete three days after the date of shipment from an IBM Authorized Distributor or a Reseller who purchased the Machine from such Distributor, as applicable. You are responsible to set up this Machine in accordance with the instructions furnished by IBM.

II. Warranty Duration:

3 months

III. Type of Service:

Customer Carry-in Exchange (CCE)

IV. Period of Warranty Service Availability:

Normal business hours of the applicable IBM Service/Exchange Center

V. Provider of Warranty Service:

IBM

There is enclosed the IBM Statement of Limited Warranty.

You may be required to provide a dated proof of purchase of this Machine from the IBM Authorized Distributor or the Reseller who purchased this Machine from such Distributor and evidence of the date of delivery to you in order to obtain warranty service. If you have any questions regarding warranty service, please call IBM at 1-800-428-2569.

The following Warranty Options are available, for a charge, under the IBM Maintenance Agreement.

IBM On-Site Exchange (IOE)

Customer On-Site Exchange (COE)

Who will be using this book

This book describes the IBM 3164 ASCII Color Display Station, and is intended as a reference for those persons who:

- Operate the display station daily.
- Design and integrate the display station into the total system.
- Generate and update the host operating system to which the display station is attached.
- Prepare the site for the setup of the display station.

How this book is organized

This book consists of six chapters:

Chapter 1, Introduction, gives a general description of the display station.

Chapter 2, Component description, describes each component of the display station in detail.

Chapter 3, Keys and messages, describes function of the keys and messages that appear at the bottom of the screen.

Chapter 4, Operations, describes how to operate the various functions of the display station.

Chapter 5, Programming considerations, tells how to write programs for the display station.

Chapter 6, Physical installation, tells how to prepare for installing the display station.

This book also has **Appendixes**, a **List of abbreviations**, a **Definition of terms**, and an **Index**.

If you need more information

The following are publications related to the IBM 3164:

IBM 3164 ASCII Color Display Station-Operator Reference and Problem Solving Guide, GA18-2319

IBM 3164 ASCII Color Display Station-Setup Instructions, GA18-2318

IBM 3101 Display Terminal Description, GA18-2033.

The following publications are useful when attaching the IBM 3164 to other devices:

IBM Series 1 "Site Preparation Manual," GA34-0050

IBM Proprinter "Guide to Operations," SC31-2586-0 (PN 6328945).

Chapter 1. Introduction	1-1
The display station	1-2
Display-station elements	1-5
Attachment to the host system	1-6
Setting up your display station	1-7
Solving a problem	1-8
Order items	1-9
Chapter 2. Component description	2-1
Video element	2-2
Logic element	2-4
Keyboard	2-6
Chapter 3. Keys and messages	3-1
Keyboard keys	3-2
Operator messages	3-30
Chapter 4. Operations	4-1
Changing SETUP menu values	4-2
Changing SELECT menu values	4-8
Defining Function keys	4-15
Changing keyboard functions	4-18
Chapter 5. Programming considerations	5-1
Data stream	5-2
Machine modes	5-10
Control characters	5-11
Commands and responses	5-16
Chapter 6. Physical installation	6-1
Environmental requirements	6-2
Electrical requirements	6-6
Appendix A. Setup Sheet	A-1
Appendix B. Select Sheet	B-1
Appendix C. Keyboard Layout Sheet	C-1
Appendix D. Modem and printer attachment instructions	D-1
Appendix E. Emulating the IBM 3101	E-1
Appendix F. Information for the Americas and the Far East	F-1
Appendix G. Information for Europe, the Middle East, and Africa	G-1
List of abbreviations	X-1
Definition of terms	X-5
Index	X-9



The IBM 3164 ASCII Color Display Station

This chapter introduces the IBM 3164 and is divided into the following sections.

The display station 1-2

Display-station elements 1-5

Attachment to the host system 1-6

Setting up your display station 1-7

Solving a problem 1-8

Order items 1-9

Accessories

Replacement parts

Additional items

Chapter 1. Introduction

The display station

The IBM 3164 ASCII Color Display Station is a general purpose asynchronous ASCII/ISO display station that is designed to attach to both IBM and non-IBM systems. It consists of three display station elements:

1. A video element with a high quality 14-inch color CRT
2. A 102-key low profile keyboard
3. A logic element.

The video element is ergonomically designed with a tilt and swivel stand and has a direct etched, anti-glare screen. The keyboard element is specifically designed for use with asynchronous ASCII/ISO systems and provides such ergonomic features as tactile feedback to the operator. The logic element provides host attachment via an RS-232C communication interface (for Model 11) or an operator selectable RS-232C/RS-422A communication interface (for Model 12) on the main port.

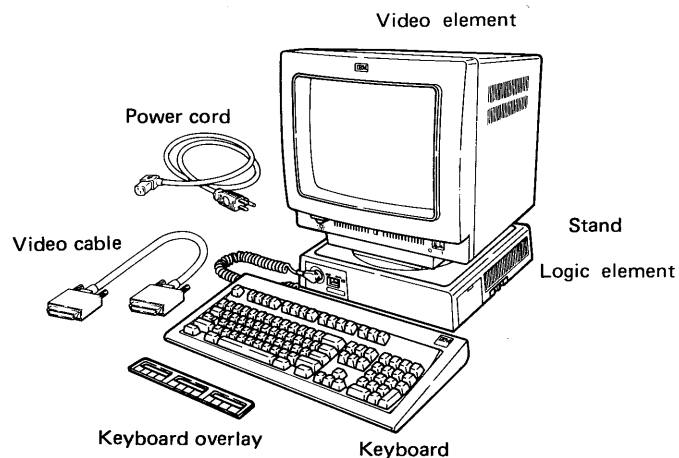

The IBM 3164 is a high-function, ASCII display station of the IBM 316X family which offers such features as menu set-up, definable function keys, split-screen, and character and field attributes. It also has such functions as smooth scroll, windowing, paging, redefinable keys and double-size characters and is compatible with the IBM 3163.

It is also able to emulate the IBM 3101, which allows easy transition for users who already have an IBM 3101.

Users can switch from one machine mode to another without changing the present software, and also obtain the advantages of the IBM 3164.

The highlights of this display station are:

Improved ergonomics

- Tilt and swivel display
- Etched/dark screen to reduce glare
- Enhanced keyboard
- Brightness control
- Compact size.

Screen characteristics

- 25 lines X 80 characters
- 8 X 16 character cell
- 14-inch color cathode-ray tube (CRT)
- Blinking, underline, non-display, reverse video attributes
- Color attributes (red, green, blue, yellow, magenta, turquoise, black, and white).

New keyboard

- Designed for ASCII applications
- Tactile feedback
- Low profile
- 12 function keys (shiftable to 24) and 3 program attention keys
- Numeric keypad
- Removable key caps.

Enhanced functions

- Menu setup
- Definable function keys
- Character and field attributes
- Line drawing characters
- Split-screen
- CRT saver
- Smooth scroll
- Windowing, paging, and partitioning
- Double high/double wide characters
- Redefinable keyboard
- Block longitudinal redundancy check (LRC)
- Host-loadable character set

Chapter 1. Introduction

- Extended field attributes
- Bi-directional auxiliary port
- IBM 3101 emulation.

Communications (Main port)

- RS-232C/RS-422A
- CRTS/PRTS/IPRTS
- Selectable speeds to 19.2 K bps
- 7/8 bits option
- Parity bit option
- Stop bit option
- XON/XOFF option
- Echo, character, and block modes.

Communications (Auxiliary port)

- RS-232C
- PRTS
- Selectable speeds to 19.2 K bps
- 7/8 bits option
- Parity bit option
- Stop bit option
- XON/XOFF option.

Display-station elements

The display station is made up of three display-station elements:

- the video element
- the logic element
- and the keyboard.

The other items shipped with the display station are:

- video cable
- power cord
- keyboard overlay to be used on the function keys
- stand
- manuals.

The modular design of the display station enables easy set up and relocation, without the help of IBM service personnel.

The video element has a 14-inch color screen for displaying numeric characters, alphabetic characters, and symbols keyed in from the keyboard or sent from the host system. These images can be displayed in 8 colors (red, green, blue, yellow, magenta, turquoise, black, and white). The top 24 lines, each containing up to 80 characters, are used for displaying data; the last (25th) line is used for displaying messages from the host system or operator messages generated by the display station. The stand attaches to the base of the video element when you set up the display station, enables you to tilt your video element up and down, and to swivel it to the left and right for comfortable viewing.

The logic element controls the various functions of your display station. It has a main port for communicating with a host system directly or via a modem, and an auxiliary port for connecting a printer or terminal. The main port uses a 25-pin female connector for connecting an RS-232C communication interface (for Model 11) or an RS-232C/RS-422A communication interface (for Model 12). The auxiliary port uses the 25-pin female connector for connecting an RS-232C communication interface.

The following models are available:

Model	Main Port	Auxiliary Port
11	RS-232C only	RS-232C
12	RS-232C and RS-422A	RS-232C

Chapter 1. Introduction

Attachment to the host system

The IBM 3164 can be attached directly to the host system or indirectly via either a modem or a protocol converter. The figure below shows examples of the display station in various system configurations.

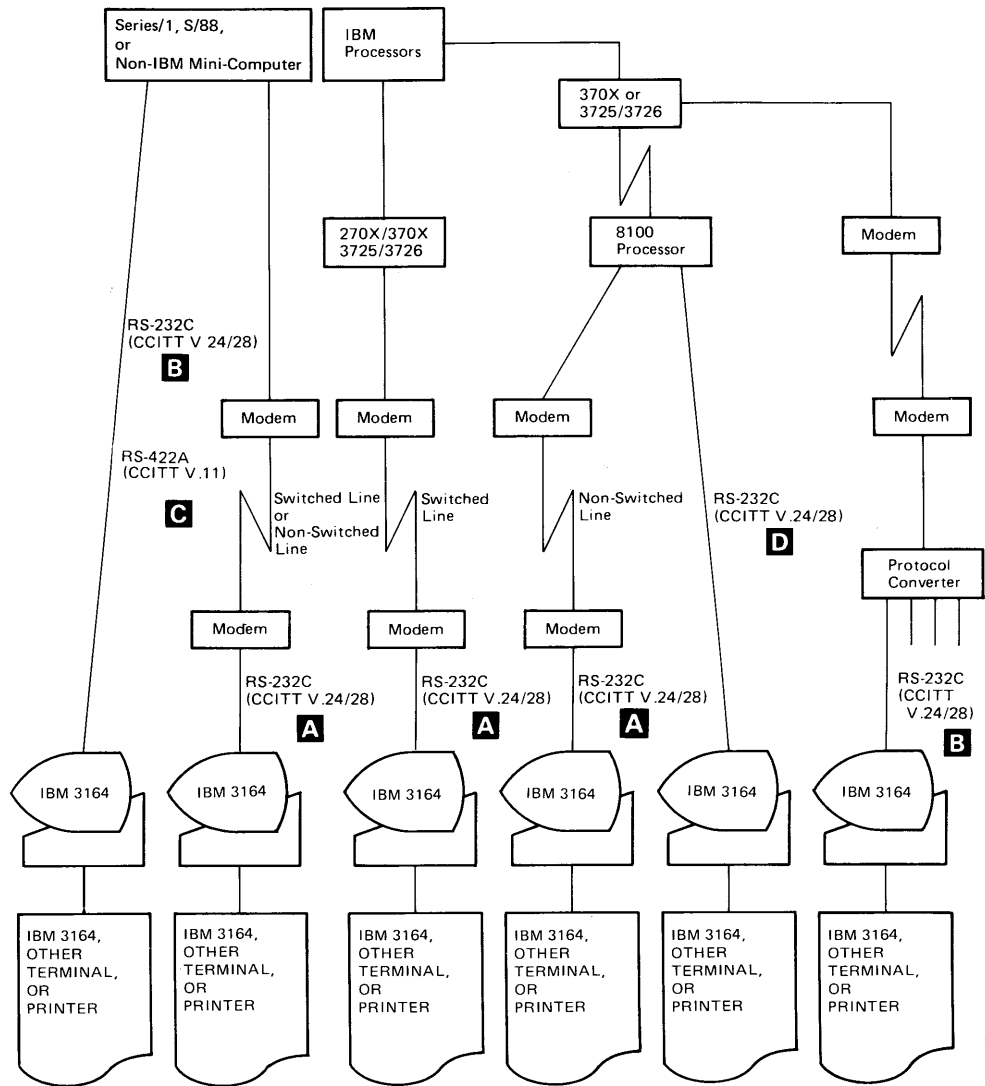

	Line speed	Models		Line speed	Models
A	50 - 1200 bps	11, 12	C	50 - 19200	12
B	50 - 19200	11, 12	D	110 - 9600	11, 12

Notes:

1. As an alternative to the modem attachment, the IBM 3164 can be connected directly to the ROLM CBX (a private branch exchange) at speeds of up to 19.2K bps through one of the following devices (RS-232C): Rolmphone DataCom Module (DCM), Data Terminal Interface (DTI), or their rack-mounted versions.
2. Some of the configurations shown may not be supported by the host system. Refer to the respective system and system programming documentation for additional information.

Setting up your display station

Setting up your display station requires:

1. Unpacking the elements
2. Setting up the elements
3. Connecting all the cables to their proper outlets (including the communication cable and the power cord)
4. Applying power and verifying that all the elements operate properly
5. Starting communications with the host system by setting the values on the setup menu
6. Modifying the keyboard layout to your own layout

For a step-by-step setup procedure, refer to *IBM 3164 ASCII Color Display Station-Setup Instructions*, which is shipped with the display station.

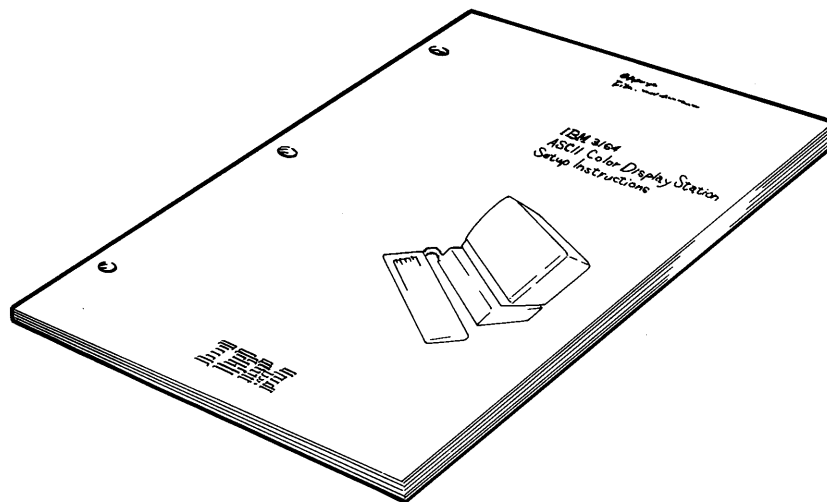

Chapter 1. Introduction

Solving a problem

If you encounter a problem while operating the display station, the "Problem Determination" section in your *IBM 3164 ASCII Color Display Station-Operator Reference and Problem Solving Guide*, will help you solve it.

If any element has a technical problem, this guide will help you isolate it. Then you can either replace the element with a spare, or return it to IBM for repair or exchange.

This guide is shipped with the display station and should be stored in the drawer located under the logic element.

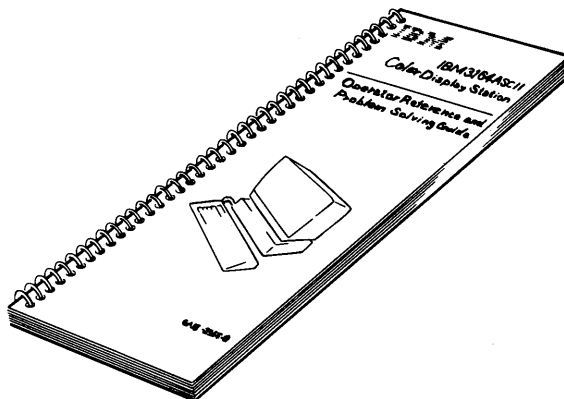

Order items

The following accessories, replacement parts, additional items, and manuals may be ordered:

Accessories

- Clear key caps with paper inserts
- Blank light key caps
- Blank dark key caps
- Paper inserts
- Key cap removal tool
- Modem cable
- Wrap socket
- Tag.

Replacement parts

- Video-element packing material
- Logic-element packing material
- Keyboard packing material.

Additional items

- Video element
- Logic element
- Keyboard
- Stand
- Power cord.

Manuals

- IBM 3164 ASCII Color Display Station Description
- IBM 3164 ASCII Color Display Station-Setup Instructions
- IBM 3164 ASCII Color Display Station-Operator Reference and Problem Solving Guide
- Keyboard overlay.

Chapter 2. Component description

This chapter describes each of the elements in detail and contains the following sections.

Video element 2-2

- Power switch
- Power-on light
- Brightness control knob
- Power cord socket
- Video cable connector
- Video cable

Logic element 2-4

- Keyboard cable connector
- Cartridge slot
- Test/Normal switch
- Logic light
- Drawer for operator document
- Main port
- Auxiliary port
- Video cable connector
- Audible-alarm volume control knob

Keyboard 2-6

- Angle adjustable legs
- Coiled cable
- Removable key caps

Chapter 2. Component description

Video element

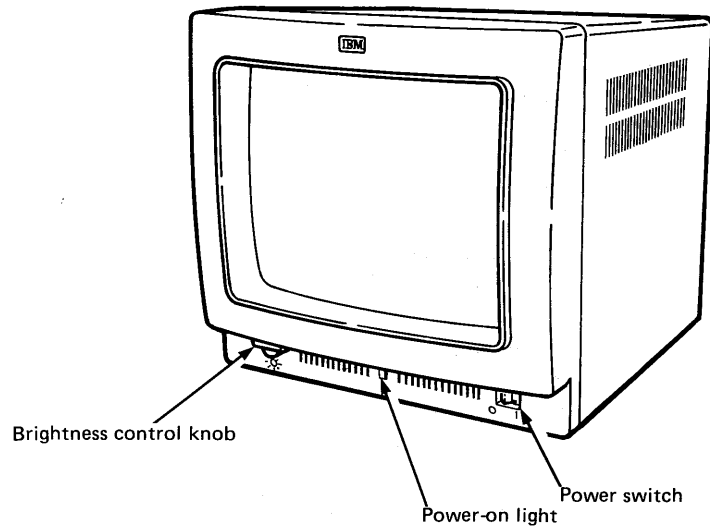

Power switch

This switch is used to apply power to the display station.

Power-on light

This light goes on when you set the power switch to on (I).

Brightness control knob

This knob adjusts the brightness of the characters on the screen. The characters on your screen get brighter when you turn this knob clockwise.

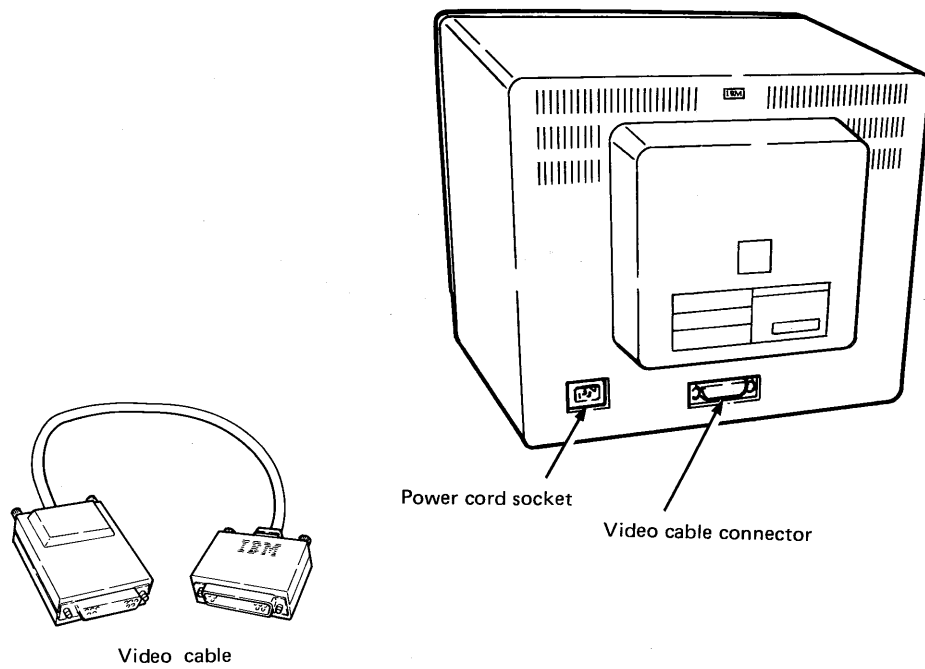

Power cord socket

This socket is used for plugging-in the power cord whose other end will be connected to a power outlet.

Video cable connector

This connector is used for plugging-in the video cable.

Video cable

This cable connects the video element to the logic element.

Chapter 2. Component description

Logic element

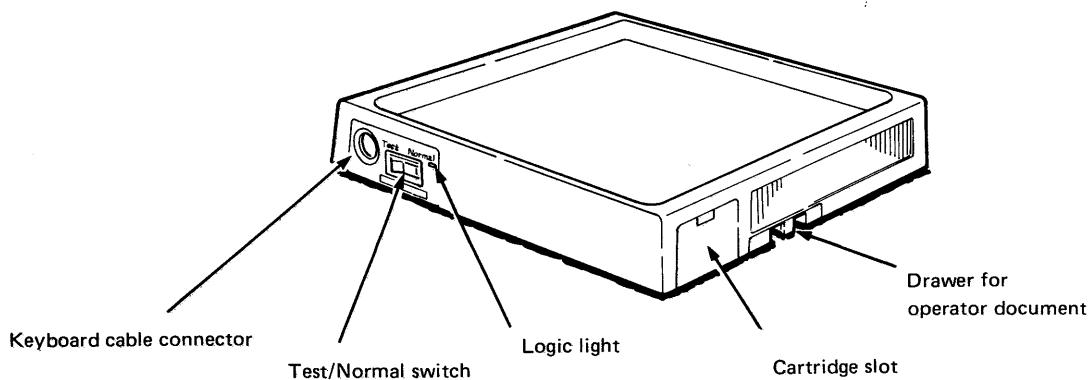

Keyboard cable connector

This connector is used for plugging-in the keyboard cable.

Cartridge slot

This slot is not used at the present.

Test/Normal switch

This switch is used to set the display station to the test mode. In test mode, a test pattern appears and the display station is logically disconnected from the host computer to perform an offline diagnostic test.

Logic light

This light tells you the present operating mode (test or normal) of the display station. The light blinks when the Test/Normal switch is set to Test and the logic element is functioning correctly. It stays on when the Test/Normal switch is set to Normal.

Drawer for operator document

This drawer is used for storing the *IBM 3164 ASCII Color Display Station-Operator Reference and Problem Solving Guide*.

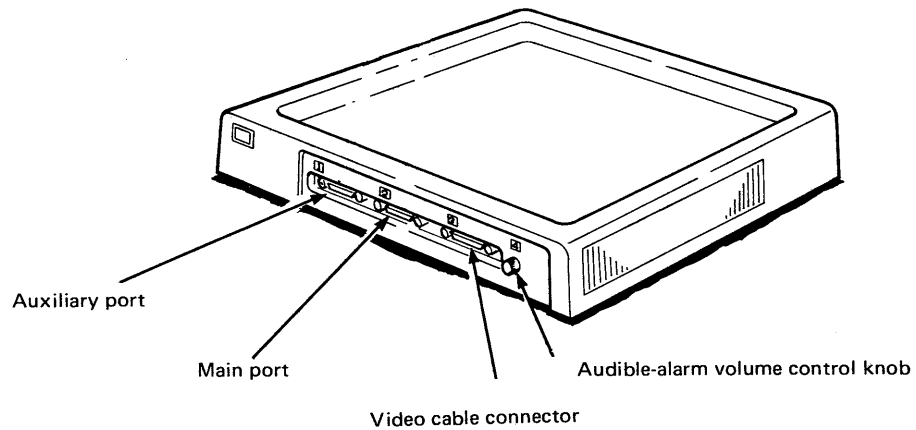

Main port

This female port is used for connecting a communication cable coming from the host system or a protocol converter, or a modem cable coming from a modem. It uses an RS-232C or an RS-422A communication interface.

Auxiliary port

This female port is used for communicating with an auxiliary input/output device such as another display station, terminal, or a printer. It uses an RS-232C communication interface.

Video cable connector

This connector is used for plugging-in the video cable.

Audible-alarm volume control knob

This knob is used to adjust the volume of the audible alarm, which sounds under program control to alert you to certain preset conditions. You can adjust the volume of the alarm by turning the knob:

- Clockwise to increase the volume
- Counterclockwise to decrease the volume.

Chapter 2. Component description

Keyboard

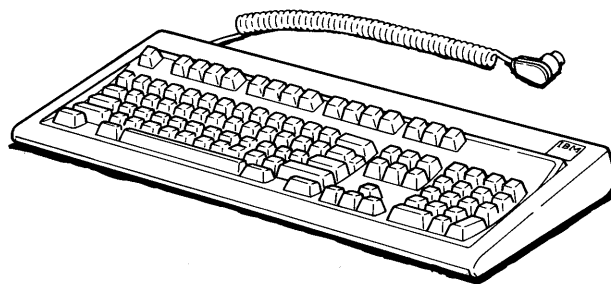

Angle adjustable legs

Adjustable legs on the bottom of the keyboard allow you to change the angle of the keyboard.

Coiled cable

This cable allows the keyboard to be moved and operated away from your desk.

Removable key caps

Some of the key caps can be removed with the key cap removal tool to form a new keyboard layout.

This chapter describes the function of the keys and the messages that appear in the operator information area (the bottom line of the screen).

Keyboard keys 3-2

Operator messages 3-30

Normal mode

Machine check

Test mode

Select mode

Define function mode

Change keys mode

Host message mode

Chapter 3. Keys and messages

Keyboard keys

This section describes the function of the keys on each keyboard. Shown below is the 102-key keyboard with the typematic keys shaded. Typematic keys are keys that will repeat an action (such as perform the same function or display the same character) for as long as you press down the key.

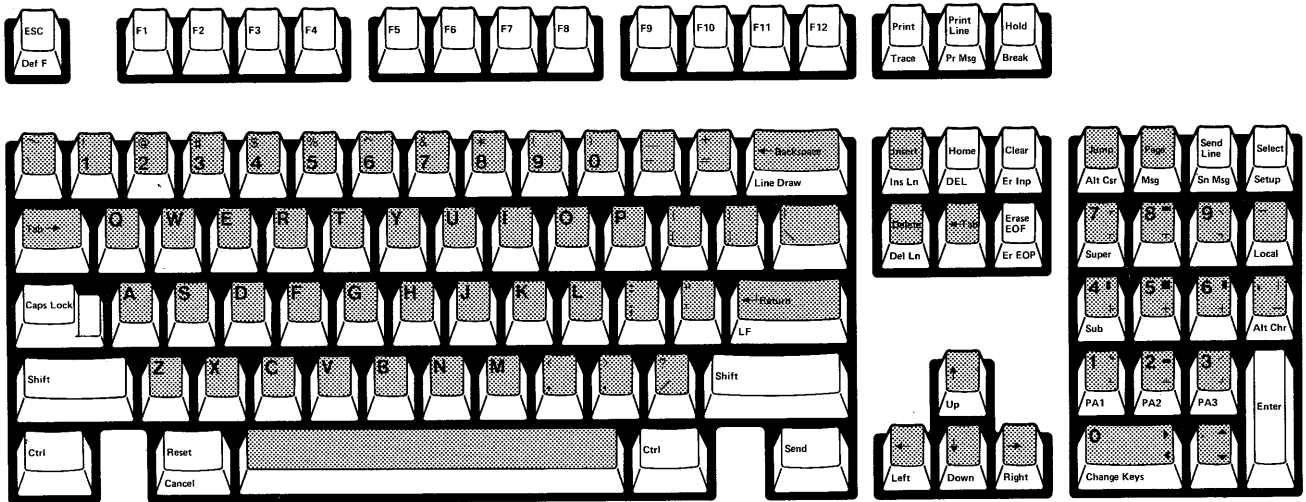

The function of the keys described in this section are functions performed in block or character mode except when specified as echo mode. These functions are local functions of the display station. A summary of the functions and the codes transmitted by each key is listed at the back of this chapter.

Alphanumeric keys

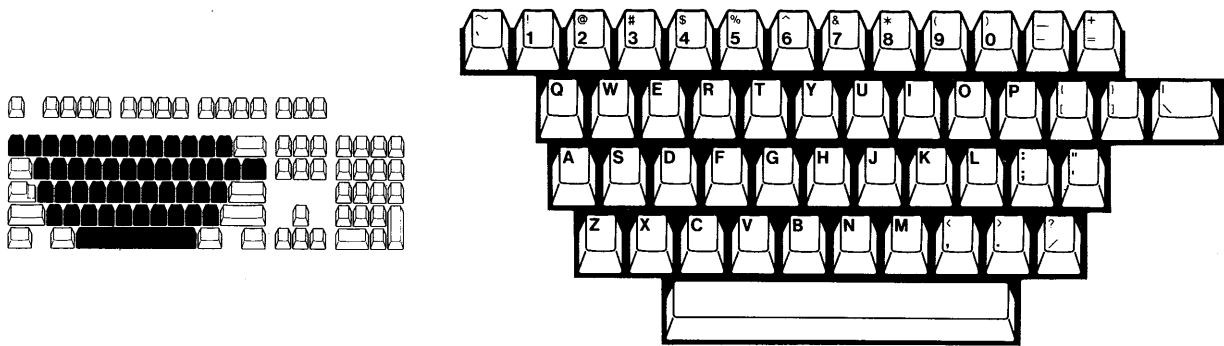

Enters the alphabet, numbers, symbols, and punctuation marks

The alphanumeric keys are used for entering the alphabet, numbers, symbols, and punctuation marks as on an ordinary typewriter. To get their upper-shift, use them with the Shift or Caps Lock key. All alphanumeric keys are typematic. You can also use the alphanumeric keys to display the alternate characters that you loaded from the host system by pressing the Alt Chr key.

When the cursor reaches the last character position of a field preceding a numeric and protected field, it automatically skips the field attribute character of the numeric and protected field, as well as that field. It reappears at the head of the next unprotected field. This function is called the auto skip function.

Alternate character (Alt Chr) key

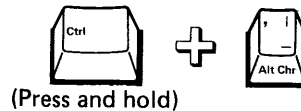
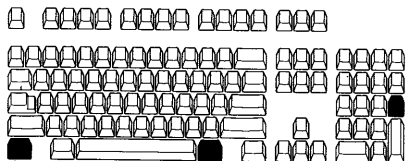

Enables the use of the alternate characters that you defined for your own purpose

This key enables you to use a symbol (alternate character) that you defined for your own purpose. When you press this key, ALT is displayed in the operator information area indicating that you are in the alternate character shift. To use an alternate character (a maximum of 94 characters), it must first have been loaded from the host system using the Load Alternate Character command and must have been assigned to a key.

When you press an alphanumeric key with an alternate character assigned, that alternate character will be displayed on your screen. If no alternate character is assigned, the original character on the keyboard is displayed. ALT disappears from the screen when you press this key again and the display station returns to the original state. For instructions on how to load these alternate characters, refer to "Commands and responses" in Chapter 5.

Chapter 3. Keys and messages

Alternate cursor (Alt Csr) key

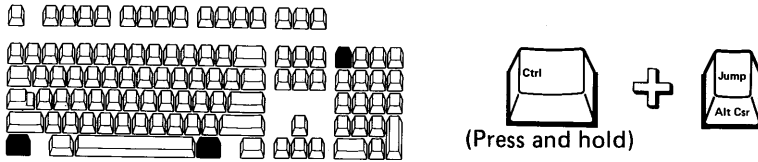

Selects from among four types

You can use this key to change the cursor to one of four types:

- Underline without blinking
- Underline with blinking
- Block without blinking
- Block with blinking.

And the last cursor type you were using is stored in the display station. The figure below shows an underline cursor on the left, and a block cursor on the right.

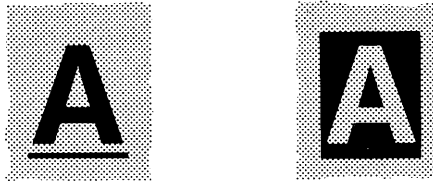

The underline cursor is always displayed in white while the block cursor has an inverted foreground and background color.

The underline cursor on a double-width character is twice the width of a normal cursor; and for a block cursor on a double height/width character, is also double the height/width of a normal block cursor.

ASCII control character keys

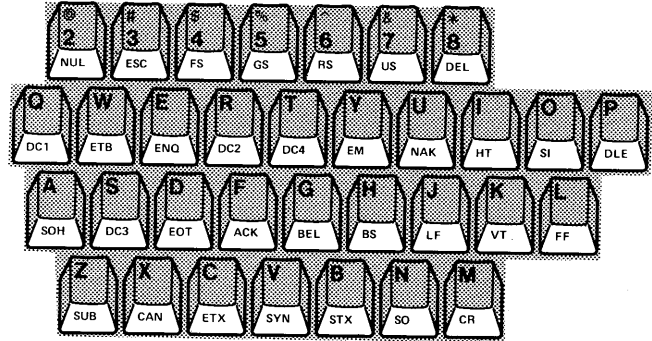
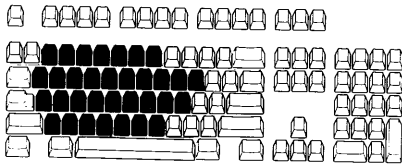

Generate an ASCII control character code when pressed together with the Ctrl key

The above keyboard layout shows the keys that generate an ASCII control character when used together with the Ctrl key. The labels in the unshaded portion are not actually engraved on the front of the keys.

For more information on the control characters, refer to Chapter 5.

← Backspace key

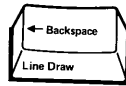
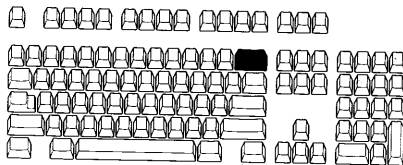

Moves the cursor to the left one position at a time

The ← Backspace key performs the same function as the cursor left (←) key.

Break key

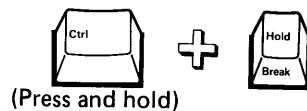
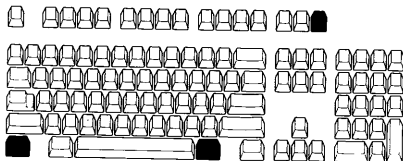

Generates the break signal when the display station is operating in PRTS or IPRTS mode

When the display station is running in PRTS mode, this key generates the break (space) signal for 170 or 500 milliseconds, depending upon the Break Signal option in the Setup menu or the Set Control command from the host system.

Chapter 3. Keys and messages

When the display station is not in PRTS mode, the audible alarm sounds and INVALID KEY is displayed in the operator information area.

Notes:

1. *The Break key is effective in RS-422A or echo mode regardless of the mode setting.*
2. *If RS-422A or echo mode is specified, the display station operates in PRTS mode regardless of the mode setting.*

Cancel key

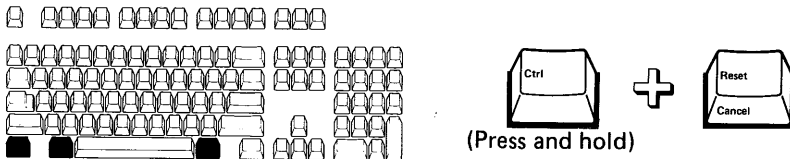

Terminates data transfer to a host system, printer, terminal, or another display station, and resets the KEYS LOCKED status

You can stop the data transfer to the host or a printer by pressing this key after:

- The Send or Print key was pressed.
- The display station received a Read or Print command.
- The auto-send function began running.

The cursor returns to the position before the data transfer and the display station sends an ASCII CAN code and a turnaround character to the host system.

When you press this key after data has been sent to the host, and the Lock KBD and Keep MDT option is on (KBD stands for keyboard, and MDT for modified data tag), the host regards the Reset KBD and MDT command as being received. Therefore, the CAN code is not transmitted to these devices. This key also resets the key-locked, the auxiliary-device-not-ready, or the auxiliary-busy status when the keyboard is locked by a host command. It then erases the KEYS LOCKED, AUX NOT READY, or AUX BUSY message on the screen.

Caps Lock key

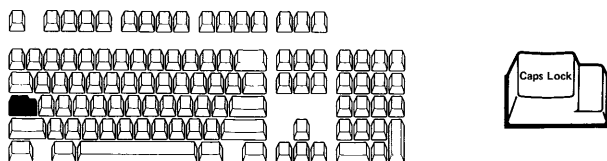

Locks the keyboard in upshift

When you press this key, CAPS appears in the operator information area and the alphabetic characters entered from the keyboard are converted to uppercase characters before being displayed (in character or block mode) or

transferred (in echo mode). CAPS disappears when you press the Caps Lock key again.

Change Keys key

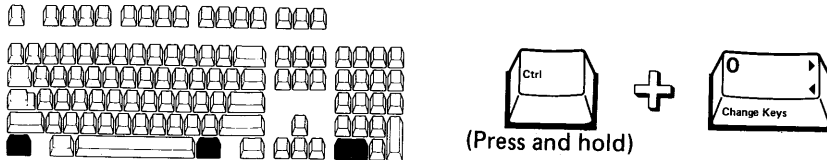

Enters change keys mode

This key is used for rearranging the keyboard layout. For further information, refer to "Changing keyboard functions in Chapter 4.

Clear key

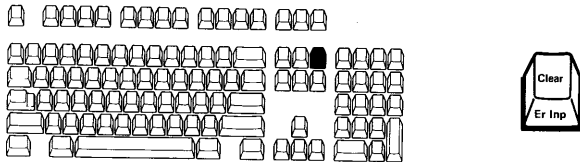

Clears and sets to nulls the active page in which the cursor is located and sets the cursor address to the first character of the page

When you press this key:

- The active page (including all attribute characters) in which the cursor is located is cleared to nulls.
- The cursor address is set to the first character position of the page, but the buffer address remains unchanged.
- The Clear response is sent to the host at the same time.
- The line attributes are also cleared.
- The column tab stops are cleared.

Control (Ctrl) key

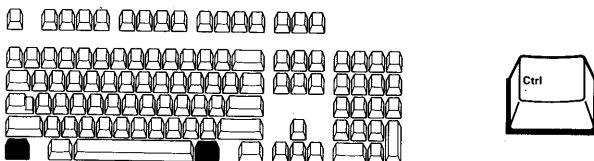

Allows you to select the function indicated on the front of a key

When you press this key, the functions shown on the front of keys are initiated and CONTROL is displayed in the operator information area.

Chapter 3. Keys and messages

Cursor up/down/left/right (↑, ↓, ←, →) keys

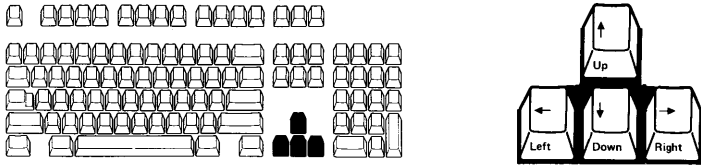

Move cursor up, down, left, or right

When you press the cursor up (↑) or cursor down (↓) key, the cursor moves up or down one line.

When you press the cursor left (←) or cursor right (→) key, the cursor moves one column to the left or right.

Each key can cause the cursor to wrap as shown below:

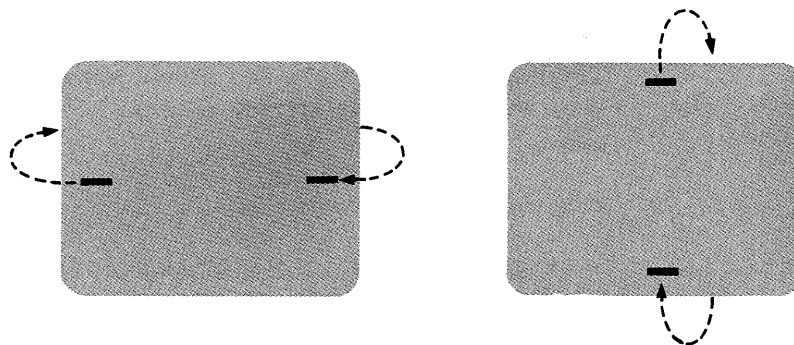

Horizontal wrapping always involves a vertical movement; that is, the cursor moves to the next or the preceding line.

Horizontal wrapping is affected by the setting of the Line Wrap option:

- When you press the cursor left (←) key while the Line Wrap option is on, the cursor moves to the last position of the bottom line of the viewport after it reaches the top position of the viewport.
- When you press the cursor right (→) key while the Line Wrap option is off, the cursor moves to the first column of the current line.

Vertical wrapping is not affected by the setting of the Line Wrap option.

Define function (Def F) key

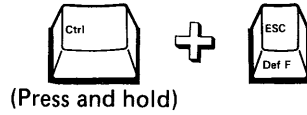
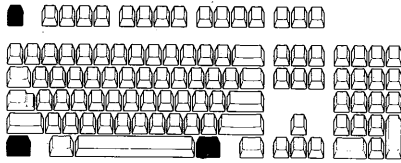

Enables the redefining of the function keys

You can redefine the function keys by using this key. The default setting is assumed until you reprogram the function keys. The validation test for the codes that you store in each Function key is not performed until its function is invoked by the keyboard. For further information on how to use this key, refer to the section on "Defining Function keys" in Chapter 4.

DEL key

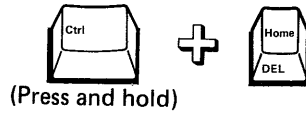
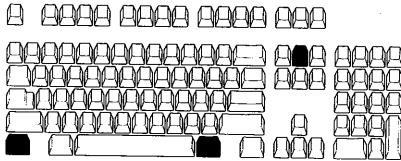

Sends the ASCII delete character (DEL) to the host

When you press this key:

- In character mode, this key sends the ASCII delete character (DEL) to the host system.
- In block mode, INVALID KEY is displayed in the operator information area.
- In block-transparent mode, the DEL character (▒) is displayed.

Delete key

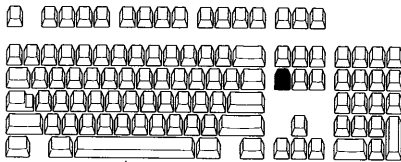

Deletes the character in an unprotected field or unformatted page at the cursor position.

When you press this key, the graphic character identified by the cursor in an unprotected field or unformatted page is deleted. The cursor does not move, and the MDT bit is set to 1. All remaining characters to the right of the cursor in the same line (or the same field, whichever ends first) move one character position to the left. The last character position of the line (or the field) is filled with a null. If the unprotected field or unformatted page has more than one line, characters in lines other than the one identified by the cursor are not affected.

When the cursor is located at an attribute character position or in a protected field, this key causes the audible alarm to sound, and WRONG PLACE is displayed in the operator information area. In this case, no character is deleted, the cursor does not move, and the MDT bit is not set.

Chapter 3. Keys and messages

In echo mode, no local function is performed. The Delete Character response is transmitted to the host.

Delete line (Del Ln) key

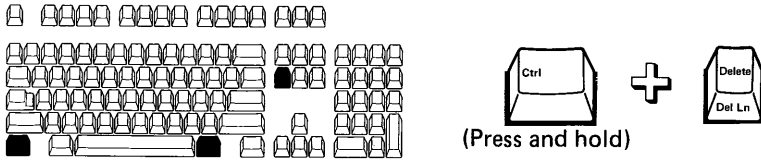

Deletes a line on which the cursor is located

This key deletes a line identified by the cursor.

If the page is unformatted, all preceding lines are moved up one line and a new null line is created at the bottom of the page.

If the page is formatted, the last characters of a line in an unprotected field are cleared to nulls and the MDT bit is set to 1.

If an attribute character is located in the cursor line, or if the current field is protected, the audible alarm sounds, and WRONG PLACE is displayed in the operator information area.

In echo mode, the Delete Line response is transmitted to the host system; however, no function is performed.

Note: If a double-height line is deleted, two single-height lines will be created.

Enter key

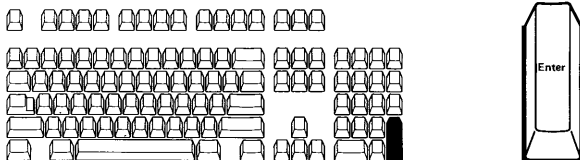

Transmits data from the active page to the application program or works like the Return key

This key performs the same function as the Return key, the Send key, or the Send Line key, depending on the Return Key and Send Line options.

Erase input (Er Inp) key

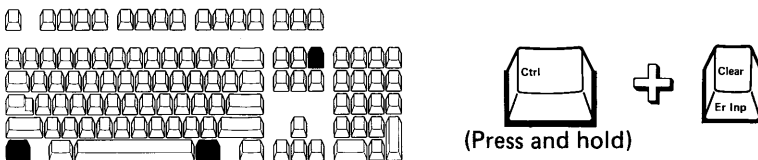

Erases all characters except those in protected fields from the top of the page to the end of the page

When you press this key in an unformatted page, characters (except tab stops) are changed to nulls. The cursor moves to the home position.

When you press this key in a formatted page, all unprotected character positions are changed to nulls. The cursor moves to the first unprotected character position in the page and the MDT bit is reset to 0 at all unprotected fields.

If there are no unprotected fields, this key does not change any character, and the cursor moves to the first character position in the page.

Erase to end-of-field (EOF) key

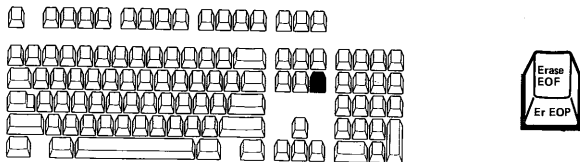

Erases data from the cursor position to the end of a line or field

If you press this key in an unformatted page, all characters from the cursor position to the end of the line in the page are changed to nulls; however, the cursor does not move, and the tab stops are not cleared.

If you press this key when the cursor is in an unprotected field of a formatted page, all characters from the cursor position to the end of the line or to the end of the field (whichever occurs first) are changed to nulls. As a result of this erase operation, the MDT is set to 1; however, the cursor does not move.

If you press this key while the cursor is located at a field attribute character position or within a protected field, the audible alarm sounds and WRONG PLACE is displayed in the operator information area.

Erase to end-of-page (EOP) key

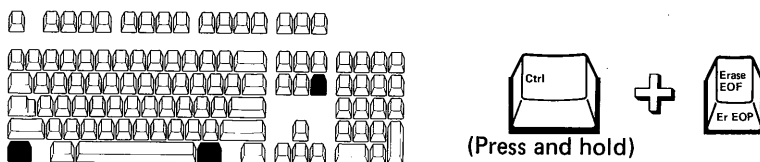

Erases all characters except those in protected fields from the cursor position to the end of a page

If you press this key in an unformatted page, characters from the cursor position to the end of the page are changed to nulls; however, the cursor does not move.

If you press this key in a formatted page, all characters in an unprotected field from the cursor position to the end of the page are changed to nulls; however, the cursor does not move, and the MDT bit is unaffected.

Chapter 3. Keys and messages

Escape (ESC) key

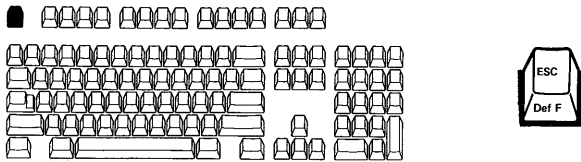

Generates the ASCII escape code

When you press this key, the ASCII escape code is generated. This is the first character of an escape sequence (ESC key plus appropriate alphanumeric key). The ESC sequences are commands to perform specific functions other than the ASCII control functions. For more information on ESC sequences, refer to "Commands and responses" in Chapter 5.

Function (F1 - F24) keys

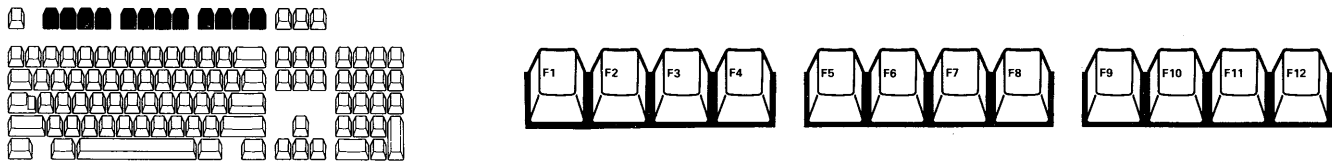

Transmit an escape sequence to the host system or generate a user defined character string

The 12 function keys each have 2 functions, a function in lower shift and a function in upper shift totalling 24 functions. Keys F13 through F24 are activated on the F1 through F12 keys with the Shift key. If you have not redefined a Function key yet, the following escape sequences will be generated:

Lower Shift		Upper Shift	
F Key	Sequence	F Key	Sequence
F1	ESC.a	F13	ESC.l.a
F2	ESC.b	F14	ESC.l.b
F3	ESC.c	F15	ESC.l.c
F4	ESC.d	F16	ESC.l.d
F5	ESC.e	F17	ESC.l.e
F6	ESC.f	F18	ESC.l.f
F7	ESC.g	F19	ESC.l.g
F8	ESC.h	F20	ESC.l.h
F9	ESC.i	F21	ESC.l.i
F10	ESC.j	F22	ESC.l.j
F11	ESC.k	F23	ESC.l.k
F12	ESC.l	F24	ESC.l.l

If a function key has been redefined, the function stored in the display station is performed. For details on how to redefine these function keys, refer to "Defining Function keys" in Chapter 4.

Hold key

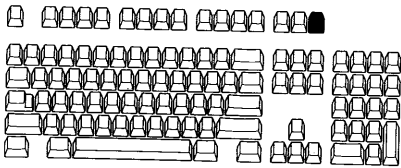

Stops screen updating from the host during normal operation

When you press this key during a normal operation, data on your screen remains displayed, and the host system cannot update the screen. The display station will keep the subsequent outbound data stream in the line buffer and the passthrough operation is suppressed until this key is pressed again. If the line buffer fills up while update is disabled, a line buffer overrun will occur. The pacing (XOFF/XON) function should be enabled to avoid the buffer overrun. For more information on pacing, refer to Chapter 5.

Home key

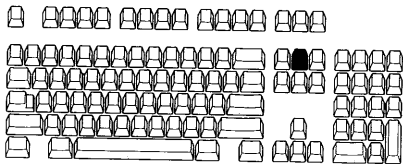

Moves the cursor to the first character position of the page

When you press this key, the cursor moves to the first unprotected character position of the current active page.

Insert key

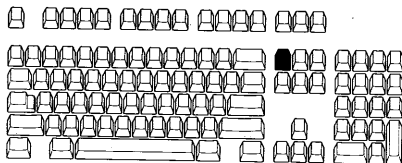

Places the keyboard in the insert state and allows characters to be inserted in a field

The function of this key depends on the Line Wrap and the Insert Character Key options.

If you press this key when the Line Wrap option is off, the display station enters the insert character mode. In this state you can insert characters only up to the end of the line.

If the Line Wrap option is on, characters will be shifted to the next line. In an unformatted page, the insert character operation stops at the end of the page.

Chapter 3. Keys and messages

If the Insert Character Key option is off and you press this key, you enter the insert character state. To exit from this state, you must press either a send (Send, Send Message, or Send Line) key, a PA key, a Function key (except when a Function key has a predefined data stream), the Clear key, the Insert key, or the Reset key. You can insert characters only when the cursor is located in an unprotected field having a null character either in the character location identified by the cursor or in any character location in the field beyond the cursor. The character formerly occupying the cursor location and all remaining characters within the field (except for null characters) are shifted one character location to the right. If the location identified by the cursor at the time of the insert operation is a null, character shifting does not occur and the MDT bit is set to 1.

When you press an alphanumeric key after all characters at or beyond the cursor in the field (from the current cursor position to the end of the page for the unformatted page) have been overwritten, or if there are no more null characters in the field, the audible alarm sounds and WRONG PLACE is displayed in the operator information area.

When you press an alphanumeric key when the cursor is located at an attribute character position within a protected field, the audible alarm sounds and WRONG PLACE is displayed in the operator information area. If a field has more than one line of characters, the character at the last position of the line is shifted to the first character position of the next line.

In echo mode, INSERT is displayed and no other function is performed at this point. After that, the Insert Character response is sent to the host whenever an alphanumeric key is pressed.

In character mode, INSERT is displayed and no other function is performed at this point. After that, when an alphanumeric key is pressed, the insert operation is performed in the same way as described above and the Insert Character response is sent to the host.

If the Insert Character Key option is on, the space code is inserted but the cursor does not move. In echo or character mode, the following sequence is sent to the host.

ESC.P.sp.BS <-----Backspace code

Insert line (Ins Ln) key

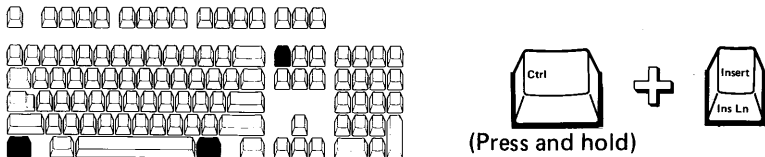

Inserts a line, depending on the options used

When you press this key, the line that contains the cursor is replaced with a line of null characters. Data in the current line and in the remaining lower lines (including the null character lines) move down one line.

If there is more than one line of null characters in an unprotected field, the last null line is lost.

If there are no null character lines, the audible alarm sounds and WRONG PLACE is displayed in the operator information area.

If the page is formatted, the insert line operation is limited to the current unprotected field.

The current unprotected field must have at least one line of null characters. As a result of the insert line operation, the MDT bit is set to 1, and the cursor moves to the first character position of the newly created line. If the cursor is in a protected field or if there is an attribute on the cursor line, the audible alarm sounds and WRONG PLACE is displayed in the operator information area.

In echo mode, the Insert Line response is transmitted to the host and no local function is performed.

Note: As a result of the insert line operation, a line attribute with the same characteristics will be created at the cursor location.

Jump key

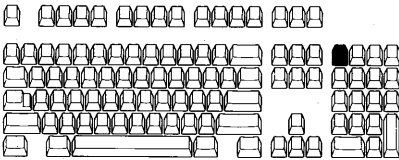

Moves the cursor to the next partition

When you press this key, the cursor moves from the viewport of the currently activated partition to the viewport of the partition with the next higher viewport identifier (VID) value on the same screen. If no higher VID value exists, the cursor goes to the viewport with the lowest VID value. The page and partition associated with the viewport to which the cursor moves become the active page and partition. The cursor is placed at the current cursor address (CCA) for that page/partition. If only one viewport exists on a screen (viewport type = 1), this key has no effect.

Line feed (LF) key

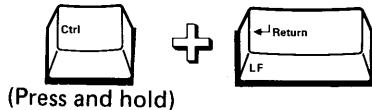
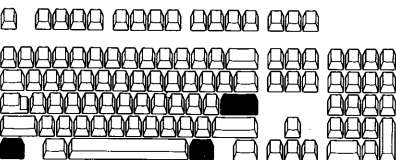

Advances the cursor to the next line

When you press this key, the cursor moves to the next line of the page if the ASCII LF option is off, or to the first position of the next line if the option is on.

Chapter 3. Keys and messages

If you press this key when the cursor is at the bottom line of the page or viewport, and the Scroll option is on, the cursor moves to the first character position or to the same column position of the newly created bottom line. If a page is formatted, the scroll function is suppressed and the cursor wraps to the top line.

Line Draw key

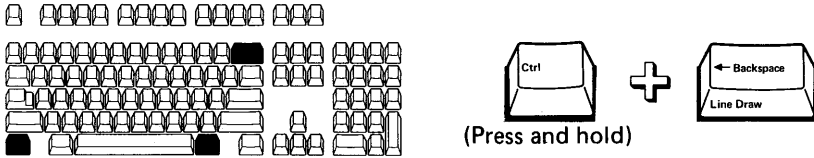

Locks the numeric keypad keys in line drawing shift

When you press this key, the keys in the numeric keypad operate as line drawing keys for making charts and graphs. To get the upper-shift line drawing functions, press and hold the Shift key. Press the Line Draw key again, to return to the original numeric shift.

Local key

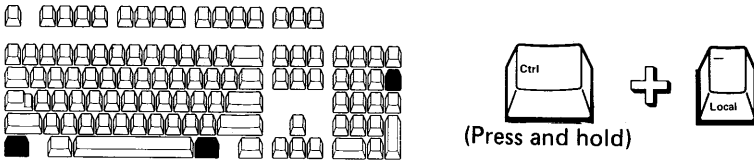

Terminates communication between the display station and the host system

When you press this key, communication stops between the display station and the host system. LOCAL appears in the operator information area. The display station can perform any keyboard-display operation but cannot transfer or receive data, except to receive and respond to the Read Status command from the host.

The display station returns to the previous state when you press the Local key again.

Message (Msg) key

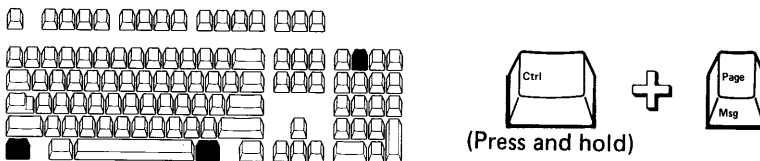

Displays a host message in the operator information area

This key is used to replace the operator information area with a host message. When the display station receives a host message, the leftmost area (which will then be indicating a mode -for example, ECHO, CHAR, BLOCK, LOCAL, DEF F, etc.) starts to blink. Press this key, and the message will be displayed in the operator information area. The message will be stored in your display

station until it receives the next message. You can see the host message again by pressing this key.

Numeric keypad keys

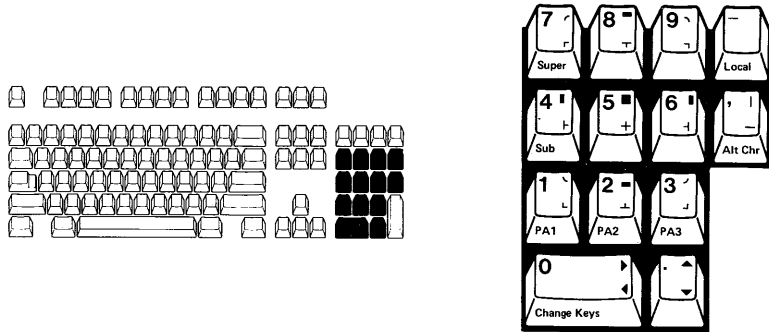

Used to enter numbers, superscripts, subscripts, and to draw lines

If the display station is not in line-draw, superscript, or subscript shift, the numeric keypad generates the numeric codes.

If the display station is in superscript or subscript shift and SUPERSCRIPT or SUBSCRIPT is displayed at the bottom of the screen, the numeric keys generate the respective superscript or subscript characters.

If the display station is in line-draw shift, these keys are used for drawing lines and boxes.

Program attention (PA1 - PA3) keys

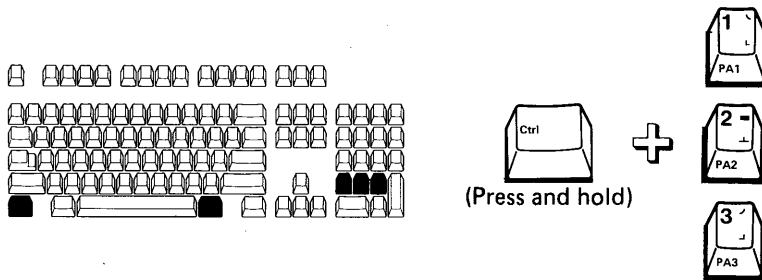

Transmit an escape sequence to the host system

When you press a PA key, the following escape sequences are generated:

- ESC!.m, when you press the PA1 key
- ESC!.n, when you press the PA2 key
- ESC!.o, when you press the PA3 key.

Chapter 3. Keys and messages

Page key

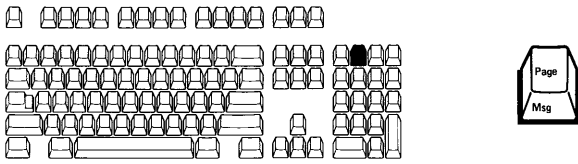

Moves the cursor to the next page

When you press this key, the window of the currently activated page advances to the page with the next higher page identifier (GID) value. If no higher GID value exists, the screen displays the viewport of the page with the lowest GID value. If only one page exists, this key has no effect.

Print key

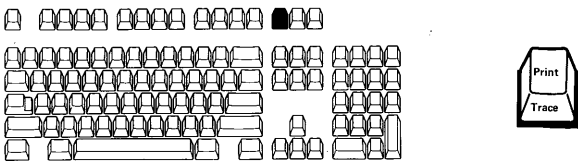

Sends the screen image to the auxiliary port

When you press this key, the entire viewport, screen, or page image is transferred to the auxiliary port. The area transferred depends on which Print option you selected on select menu 3 or you specified by a Set Control 7 command. The cursor does not move.

Note: The line-draw symbols, subscripts, superscripts, alternate characters, and field attribute characters are converted to space code (hex '20') on the printer.

Print Line key

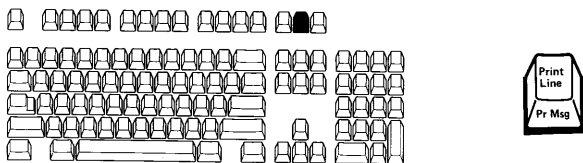

Sends the contents of the cursor line to the auxiliary port

When you press this key, the line that contains the cursor is transferred to the auxiliary port. The cursor does not move.

Note: The line-draw symbols, subscripts, superscripts, alternate characters, and field attribute characters are converted to space code (hex '20') on the printer.

Print message (Pr Msg) key

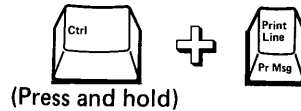
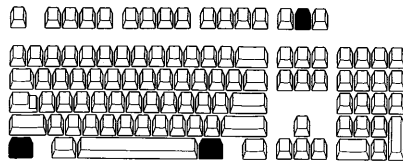

Sends data from the position specified by the send mark (^) to the cursor position, to a printer

When you press this key, the data from the first character position below the line specified by the send mark (^) to the cursor position is transferred to the auxiliary port. For example, to make a printout:

1. Position the cursor to any point one line above the data from where you want to start printing.
2. Display the send mark (^) at that location by pressing the ESC key and then a capital E. This is the Write Send Mark command.
3. Move the cursor to one character after the data you want to stop printing.
4. Press and hold the Ctrl key, then press the Pr Msg key. The data you specified will be printed. The cursor and the send mark do not move.

If no send mark is found, data is transferred from the top of the screen to the cursor position. If the send mark is located after the cursor position and there is more than one field attribute character, the operation always wraps.

Note: The line-draw symbols, subscripts, superscripts, alternate characters, and field attribute characters are converted to space code (hex '20') on the printer.

Reset key

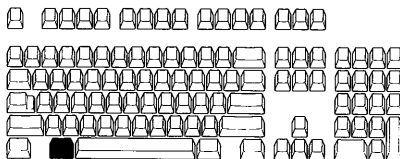

Resets the superscript and subscript shift conditions, the insert mode condition, and also some error conditions

This key is used to erase the error/status indications in the operator information area. After you press this key, the error/status indication is either erased or the condition with the highest priority is displayed in the operator information area as a reminder.

This key also resets the superscript or subscript shift status and the insert mode.

Chapter 3. Keys and messages

← Return key

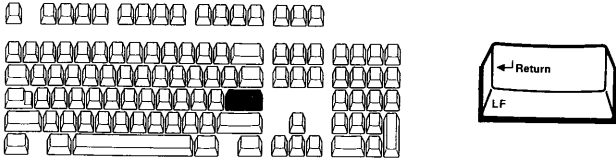

Moves the cursor to the next line or to the first unprotected position after the current line

When you press this key when the cursor is in an unformatted page, the cursor moves to the first character position of the:

- Next line (NL function), if Auto LF is on and CR/CR-LF is set to CR.
- Third line (NL plus LF function), if Auto LF is on and CR/CR-LF is set to CR-LF.
- Current line (CR function), if Auto LF is off and CR/CR-LF is set to CR.
- Next line (NL function), if Auto LF is off and CR/CR-LF is set to CR-LF.

If you press this key when the cursor is at the bottom line of the page and the Scroll option is off, the cursor moves to the top position instead of the next lower line, or to the first character position of the second line instead of the third line.

If you press this key when the cursor is at the bottom line of the page and the Scroll option is on, the cursor moves to the first character position of the newly created bottom line. If the page is formatted, the scroll function is suppressed. The scrolling-up varies by the following conditions.

- If Auto LF is on and CR/CR-LF is CR, then one line will scroll up.
- If Auto LF is on and CR/CR-LF is CR-LF, then two lines will scroll up.
- If Auto LF is off and CR/CR-LF is CR, then no lines will scroll up.
- If Auto LF is off and CR/CR-LF is CR-LF, then one line will scroll up.

In the formatted page, the operation of the Return key depends on the Return Key option.

- If the Return Key option is on, this key operates in the same way as the unformatted page.
- If the Return Key option is off, this key moves the cursor to the first unprotected character position of the next line. If the page has no unprotected fields, the cursor is repositioned to the top of the page.

Setup key

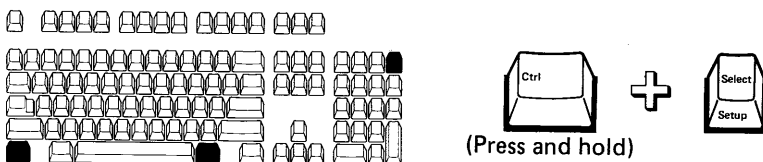

Enters setup mode to update setup values

This key is used to set up the communication conditions and terminal ID. When you press this key together with the Ctrl key, the Setup menu appears on your screen and you can select your setup conditions. For details on how to use this key, refer to "Changing SETUP menu values" in Chapter 4.

Select key

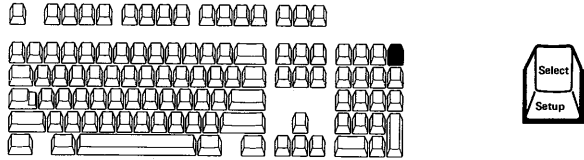

Enters select mode to update select values

When you press this key, the Select menu appears. This menu is used to set the operating conditions of your machine. For details on how to use this key, refer to "Changing SELECT menu values" in Chapter 4.

Send key

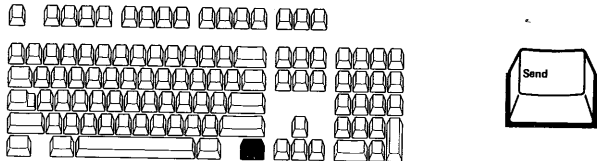

Sends data to the host system, depending on the operating mode and options

The function of this key depends on the operating mode and the Send Line option of your display station.

When you press this key in character or echo mode, the display station transmits only the AID code and a turnaround character to the host.

When you press this key in block mode, data transmission depends on the Send Data Format option. When you press this key in an unformatted page, the entire page data is transmitted to the host. If you press this key in a formatted page, the volume and type of data transmitted (modified data only or unprotected data only) will depend on the field data transmission mode set by the host. See Chapter 5, "Commands and responses" for details.

Send Line key

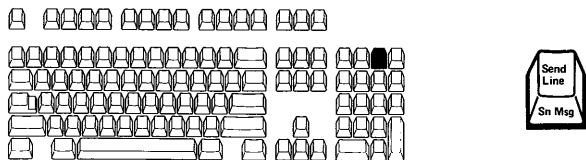

Sends data to the host system, depending on the operating mode and options

The function of this key depends on the operating mode and the Send Line option of your display station.

Chapter 3. Keys and messages

When you press this key in character or echo mode, the display station transmits only the AID code and a turnaround character to the host.

When you press this key in block mode, data transmission depends on the Send Data Format option. When you press this key in an unformatted page, the current line data is transmitted to the host. If you press this key in a formatted page, the volume and type of data transmitted (modified data only or unprotected data only) will depend on the field data transmission mode set by the host. See Chapter 5, "**Commands and responses**" for details.

Send message (Sn Msg) key

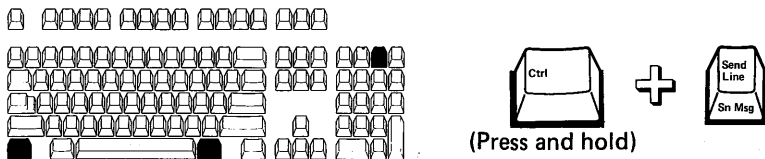

Sends data to the host system, depending on the operating mode and options

The function of this key depends on the operating mode of your display station.

In character or echo mode, the display station transmits only the AID code and a turnaround character to the host.

In block mode, the type of data transmission depends on the Send Data Format option. This key causes the display station to transfer data in the same way as the Pr Msg key, but to the host instead of the printer.

After data transmission, the cursor moves as follows:

- If the Lock KBD and Keep MDT option is off, the cursor moves to the first character position of the next line. In addition, the affected MDT bit is automatically reset to 0.
- If the Lock KBD and Keep MDT option is on, the keyboard is locked and the cursor does not move until the Reset KBD and MDT command is received. When the Reset KBD and MDT command is received, the keyboard is unlocked and the cursor moves to the first character position of the next line. In addition, the affected MDT bit is automatically reset to 0.

If you press this key in a formatted page, the volume and type of data transmitted (modified data only or unprotected data only) will depend on the field data transmission mode set by the host. See Chapter 5, "**Commands and responses**" for details.

Shift keys

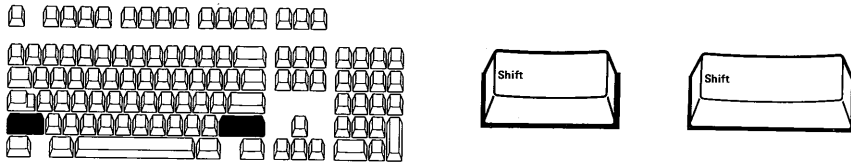

Perform the upper-shift functions

When you press this key, you can use the upper-shift functions of the alphanumeric keys and UP SHIFT is displayed in the operator information area. You can also use this key to get the upper-shift functions of the line drawing keys on your numeric keypad.

Subscript (Sub) key

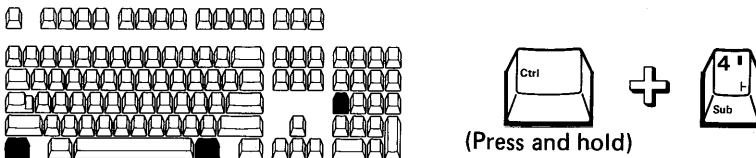

Allows you to enter subscripts when used together with the numeric keys

When you press this key SUBSCRIPT appears in the operator information area, enabling you to press any numeric (0 - 9) key on the numeric keypad. That number will be displayed as a subscript regardless of the setting of the Shift key and SUBSCRIPT will disappear from the screen. If you press a key other than a numeric key, the audible alarm will sound, and SUBSCRIPT will remain displayed until you enter a numeric key or the Reset key.

Superscript (Super) key

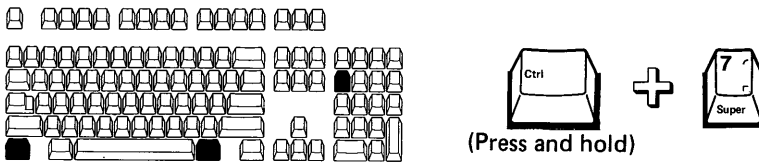

Allows you to enter superscripts when used together with the numeric keys

When you press this key SUPERScript appears in the operator information area, enabling you to press any numeric (0 - 9) key on the numeric keypad. That number will be displayed as a superscript regardless of the setting of the Shift key and SUPERScript will disappear from the screen. If you press a key other than a numeric key, the audible alarm will sound, and SUPERScript will remain displayed until you enter a numeric key or the Reset key.

Chapter 3. Keys and messages

Tab → key

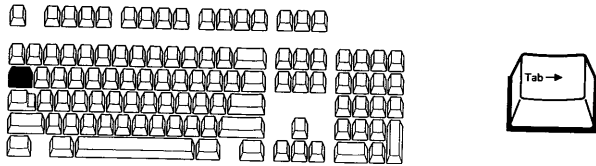

Moves the cursor to the first character of the next tab position

If you press this key in an unformatted page, the cursor moves to the next tab position.

If the Line Wrap option is off, tab stops are always set at the first and the last character positions of each line in the viewport. Pressing this key after the cursor reaches the end of the current line causes the cursor to wrap to the first character position of the same line.

If the Line Wrap option is on, pressing this key after the last tab stop of the current line causes the cursor to wrap to the first tab stop of the next lower line. If the Line Wrap option is on and no column tab stops are specified, the tab-stop position is at the top of the page.

If the scroll function is enabled in the unformatted page, scrolling-up occurs after the cursor passes the last tab-stop position of the page.

If you press this key in a formatted page when the Tab/Back Tab Key option is on, the tab operation is the same as the unformatted page. If this option is off, the cursor moves to the first character position of the next unprotected field. All column tab stops are ignored. If a page has no unprotected fields, the cursor goes to the top of the page.

Note: The Tab → key works as the ←Tab (Back Tab) key while the Shift key is held down.

← Tab (back tab) key

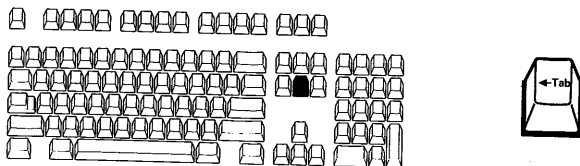

Moves the cursor back to the previous tab position

If you press this key in an unformatted page, the cursor moves one tab position to the left. If the Line Wrap option is off, the tab stops are always set at the first and the last character positions of each line in a page. Pressing this key after the cursor reaches the first character position of the current line causes the cursor to wrap to the end of the same line. If the Line Wrap option is on, pressing this key after the first tab-stop of the current line causes the cursor to wrap to the last tab stop of the upper line. If the Line Wrap option is on and no column tab stops are specified, the tab stop position is at the first position of the page.

If the scroll function is enabled in the unformatted page, scrolling-down occurs after the cursor passes the first tab-stop position of a page.

If you press this key in a formatted page when the Tab/Back Tab Key option is on, the tab operation is the same as the unformatted page. If this option is off, the cursor goes back to the first character position of the unprotected field. All column tab stops are ignored. If a page has no unprotected fields, the cursor goes to the top of the page.

Trace key

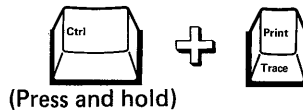
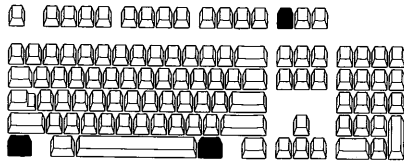

Transfers data to the auxiliary port

When you press this key, the display station transfers data to a device attached to the auxiliary port and TRACE is displayed in the operator information area. Pressing this key a second time terminates the data transfer.

The received/transmitted data is transferred to the auxiliary port without data conversion. The Trace option specifies which data (inbound, outbound, or both) is to be transferred to the auxiliary device.

If you press this key in local mode, the audible alarm sounds and INVALID KEY is displayed in the operator information area.

Note: The main and auxiliary ports must have the same line speed in order for the Trace key to operate.

Left/Right keys

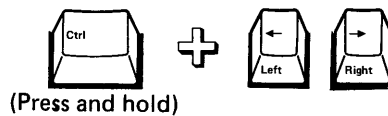
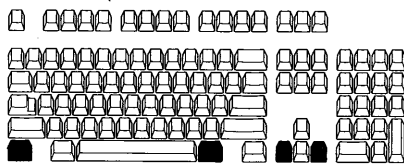

Moves data in a wide page left or right

These keys enable you to move the page data left or right one column at a time, relative to the viewport.

During window left, the cursor moves right with the page until it is at the right edge of the viewport. Windowing of the page may continue, but the current cursor position is moved to the left so that the screen cursor stays in the viewport. Similarly, during windowing right, the cursor position can be moved to the right.

When the window is placed at the left edge of the page, pressing the Left key causes an error, and the audible alarm sounds. Similarly, pressing the Right key causes an error at the right edge of the page.

Chapter 3. Keys and messages

The following figure illustrates the effect of window right on the current cursor address (CCA). When you window right between the window positions A and C, the CCA remains unchanged within the page. However, when windowing continues past these three positions (to D in the example), the display station automatically moves the CCA to a new position (in the same row) so that the cursor remains within the viewport.

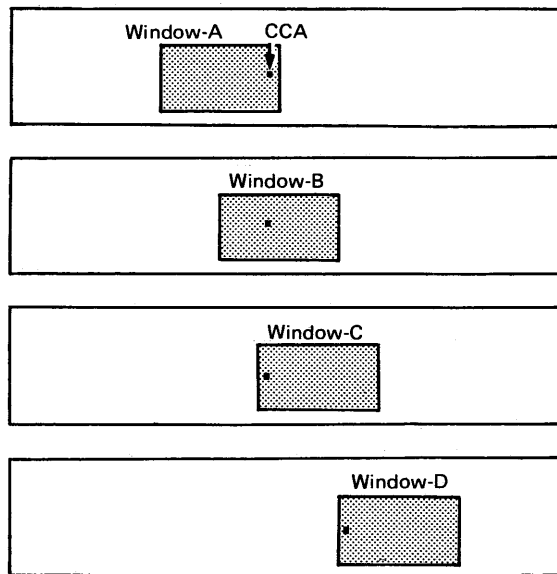

Up/Down keys

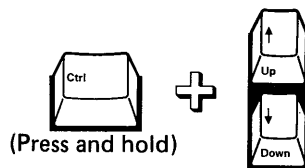
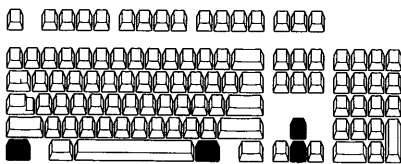

Moves data in a long page up or down

When the page is longer than the viewport, these keys enable you to move the page data up or down one row at a time, relative to the viewport. During window-up, the cursor moves down with the page until it is at the bottom row of the viewport. Windowing of the page may continue, but the current cursor position is moved up the page so that the screen cursor stays in the viewport. Similarly, during windowing down, the cursor position can be moved down the page. If the page has the same dimension as the window/viewport, the Up and Down keys have no effect.

When the window is placed at the top of the page, pressing the Up key causes an error, and the audible alarm sounds. Similarly, pressing the Down key causes an error at the bottom of the page.

The following figure illustrates the effect of window down on the current cursor address. When you window down between window positions A and C, the CCA remains unchanged within the page, and the cursor itself moves

vertically within the viewport. However, when windowing continues past these three positions (to D in the example), the display station automatically moves the CCA to a new position (in the same column) so that the cursor remains within the viewport.

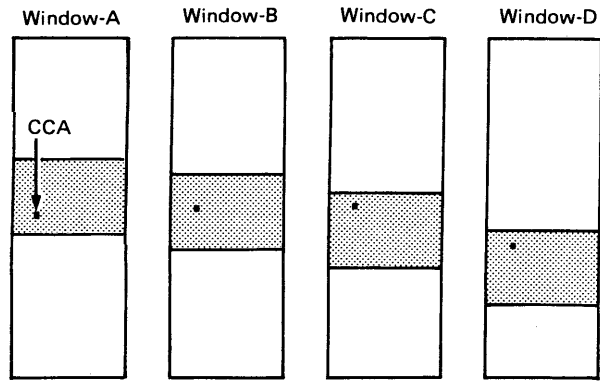

Chapter 3. Keys and messages

Summary of keys

Key Name	Operating Mode			Local Mode	Transmitted Characters	Functions Performed
	Echo	Char	Block *1			
94 ASCII alphanumeric	T	F/T	F	F	Alphanumeric characters	Alphanumeric characters are displayed.
Space bar	T	F/T	F	F	Space	Space
Superscript	T	F/T	F	F	Superscript characters	Superscript characters are displayed
Subscript	T	F/T	F	F	Subscript characters	Subscript characters are displayed
Line drawing keys	T	F/T	F	F	Line-drawing character	Line-drawing characters are displayed.
32 control characters	T	F/T	F/-	F/-	Control character	See Chapter 5.
DEL	T	T	-	-	DEL	No functions performed. Alarm sounds in block mode.
ESC	T	F/T	F	F	ESC	*2 See Chapter 5.
↑	T	F/T	F	F	ESC.A	Cursor up
↓	T	F/T	F	F	ESC.B	Cursor down
→	T	F/T	F	F	ESC.C	Cursor right
←	T	F/T	F	F	ESC.D	Cursor left
Home	T	F/T	F	F	ESC.H	Cursor home
← Backspace	T	F/T	F	F	BS	Backspace
← Return	T	F/T	F	F	CR/CR.LF	New line
Tab →	T	F/T	F	F	HT	Tab
← Tab	T	F/T	F	F	ESC.2	Back tab
Enter	T	T	S	-	ESC.8.LTA or ESC.I.8.LTA	*3
	T	F/T	F	F	CR/CR.LF	
Up	T	F/T	F	F	ESC.sp.A	Window up
Down	T	F/T	F	F	ESC.sp.B	Window down
Right	T	F/T	F	F	ESC.sp.C	Window right
Left	T	F/T	F	F	ESC.sp.D	Window left
Jump	T	F/T	F	F	ESC."A	Jump partition
Page	T	F/T	F	F	ESC.I.A	Jump page
Clear	T	F/T	F/T	F	ESC.L.LTA	Clear
Erase EOF	T	F/T	F	F	ESC.I	Erase to end of line or field
Erase EOP	T	F/T	F	F	ESC.J	Erase to end of page
Er Inp	T	F/T	F	F	ESC.K	Erase input
Insert	T	F/T	F	F	ESC.P.Pa	Insert character
Delete	T	F/T	F	F	ESC.Q	Delete character
Ins Ln	T	F/T	F	F	ESC.N	Insert line
Del Ln	T	F/T	F	F	ESC.O	Delete line

Key Name	Operating Mode			Local Mode	Transmitted Characters	Functions Performed
	Echo	Char	Block *1			
Print Line	F	F	F	F		Print line
Pr Msg	F	F	F	F		Print message Print viewport Print screen
Print	F	F	F	F		Print page
Cancel	F	F	F	F		Cancel the print operation
Send Line	T	T	S	-	ESC.I.8.LTA	Send line
Sn Msg	T	T	S	-	ESC.sp.8.LTA	Send message
Send	T	T	S	-	ESC.8.LTA	Send Page
F1 - F24	T T	T F/T	T F	- F	Function AID Data defined in Function key	*4
PA1 - PA3	T	T	T	-	PA AID	Transmits program attention AID
Trace	F	F	F	-		
Break	T	T	T	-		Space hold for 170 ms or 500 ms
Hold	F	F	F	-		Hold screen
Shift	F	F	F	F		Shift up
Ctrl	F	F	F	F		Control shift
Caps Lock	F	F	F	F		Shift lock
Alt Csr	F	F	F	F		Cursor change
Alt Chr	F	F	F	F		Enable alternate character
Local	F	F	F	F		Local mode Operation entry/exit
Msg	F	F	F	F		Replace indicator row message with host message
Def F	F	F	F	F		Define function mode entry/exit
Reset	F	F	F	F		Reset keyboard Lock
Setup	F	F	F	F		Setup mode entry/exit
Select	F	F	F	F		Select mode entry/exit
Change Kéys	F	F	F	F		Keyboard define mode entry/exit
Super	F	F	F	F		Superscript mode on/off
Sub	F	F	F	F		Subscript mode on/off
Line Draw	F	F	F	F		Line drawing mode on/off

Notes:

- T The keyed-in character, control code, or ESC sequence is transmitted to the host.
- F Function is performed.
- No character is sent or no function is performed. The audible alarm sounds and INVALID KEY is displayed in the operator information area except for DLE, STX, ETX, and EOT. For DLE, STX, ETX, and EOT, no lock condition occurs.
- S Send operation is initiated.
- *1 The LTA (Line Turnaround) character is applied at the end of a transmission (T) of the ESC sequence in block mode except the Break key.
- *2 'F' means that only the valid ESC sequences are performed. Others cause the audible alarm to sound and INVALID KEY is displayed in the operator information area.
- *3 When the Enter Key option is off, the Enter key works as the Send or Send Line key. If the option is on, it performs the same function as the New Line key.
- *4 When the Function key is set to AID, the function AID is transmitted. For the data stream, the Function key performs the function defined.

Chapter 3. Keys and messages

Operator messages

The *operator information area* is used to display the operating status of the display station, a host message, or a warning message when a problem is detected in one of the elements. These messages are always displayed within defined fields of the 25th line.

The operator information area is shown below.

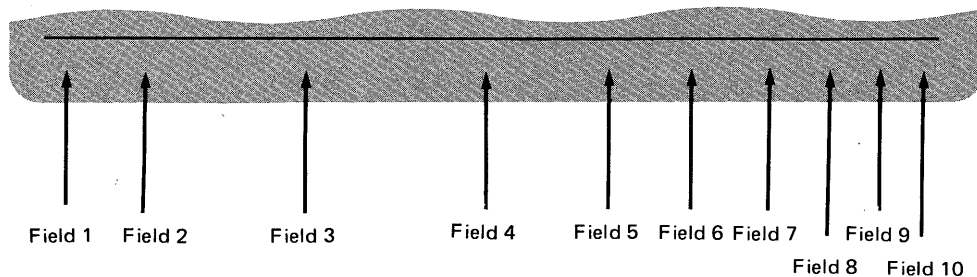

When the entire operator information area starts to blink, it means that either a setup/select, a Function key, or a keyboard layout value stored in your display station has been destroyed, and set to their default values. To reset these values back to their original values, refer to the *IBM 3164 ASCII Color Display Station-Operator Reference and Problem Solving Guide*.

Normal mode

Field	Message	Indication
1	ECHO	The display station is in echo mode.
	CHAR	The display station is in character mode.
	BLOCK	The display station is in block mode.
	LOCAL	The display station is in local mode and is not interacting with the host system. In this mode you can enter characters from the keyboard without sending these characters to the host system; they will be displayed only on the screen.
2	TRANSP	The display station is in transparent mode. In this mode, all 128 ASCII codes are displayed and characters entered from the keyboard are also transferred to the host system in character mode. However, the 32 ASCII control characters and the escape and data-link-escape sequences (except for DLE.ETX), do not perform their functions. Keys that do not generate the 128 ASCII codes (i.e. Shift, Caps Lock, Local, Reset, etc.) perform their functions.
3	COMM NOT READY 1	The 'clear to send' (CTS) signal is not turned on within 2 seconds from data transfer commencement to the host system.
	COMM NOT READY 2	The 'data set ready' (DSR) signal does not exist on the main port after the 'data terminal ready' (DTR) signal is turned on.
	AUX NOT READY	Displayed when the host system or the operator attempts to transfer data to the auxiliary port, but the device is not ready to receive it. This indicator is automatically reset when the auxiliary device becomes ready to receive data. When the Cancel key is pressed, this indicator is erased and the print data or the passthrough data is discarded. Reset by the Cancel key.
	AUX BUSY	Displayed when data transmission from the auxiliary port to an auxiliary device is terminated by an XOFF condition. It disappears when the auxiliary port receives an XON from an auxiliary device. When the Cancel key is pressed, this indicator is erased and the print data or the passthrough data is discarded. Reset by the Cancel key.
	HOLD SCREEN	Displayed when the Hold key is pressed, and disappears when the Hold key is pressed again.
	HOST BUSY	Displayed when the inbound data transmission is terminated by an XOFF condition. It disappears when XON is received.
	HOST PROG WRONG	Displayed when the display station receives an undefined command or an invalid parameter. It will be removed by the Reset key.
	INVALID KEY	Displayed when any of the following operator action is taken: <ul style="list-style-type: none"> • An invalid control character key is pressed in block or local mode (except in transparent mode) • An invalid key is pressed when the superscript or subscript key was being depressed • The DLE and STX control character generating keys are pressed when an operator initiated transparent mode is inhibited.
	KEYBOARD ERROR	The keyboard scan code error is detected.

Chapter 3. Keys and messages

Field	Message	Indication
	KEYS LOCKED	The keyboard is locked by the host program. Reset by the Cancel key.
	MUST ENTER	The must-enter field remains unchanged when the send operation is initiated.
	MUST FILL	The must-fill field was not filled when the send operation was initiated or when the cursor is moved out of the field.
	NUMERIC	The cursor is located in a numeric field.
	PRINTING	Data is being transferred to the auxiliary port by the use of the Print command or the Print key.
	RECEIVING	The display station is in CRTS receive state.
	SENDING	The display station is sending data to the host system.
	WRONG PLACE	Displayed when one of the following operator actions is taken: <ul style="list-style-type: none"> • An invalid key is pressed in a protected field, a protected character position, or at an attribute character position. • The Insert key operation without enough null spaces in a line.
4	INSERT	The display station is in the insert-character mode.
5	ALT	The Alt Chr key was pressed and the display station is in the alternate-character shift state. This indicator is replaced by the SUPER or SUB indicator when the Super or the Sub key is pressed, indicating that the Alt Chr shift state has been changed to the superscript or the subscript shift.
6	CAPS	The keyboard is in the caps-lock state.
	CONTROL	The Ctrl key was pressed and the display station is in the control-shift state.
	NO KEYBOARD	The display station is operating without the keyboard and that the present operation can be continued.
	SUBSCRIPT	The Sub key was pressed and the display station is in the subscript-shift state.
	SUPERSCRIPIT	The Super key was pressed and the display station is in the superscript-shift state.
	UP SHIFT	The keyboard is in the up-shift state.
7	DRAW	The Line Draw key was pressed and the display station is in the line-draw shift state.
8	TRACE	The trace function has been activated.
9	P.x	x equals the current active page number (PID) 1, 2, 3, or 4.
10	(xxx,yyy)	The cursor address (xxx equals row, yyy equals column) in the current active page.

Machine check

When one of the following messages appears, refer to *IBM 3164 ASCII Color Display Station-Operator Reference and Problem Solving Guide*.

Field	Message	Indication
3	PROBLEM IN LOGIC ELEMENT	There is an unrecoverable error in the logic element.
	PROBLEM IN LOGIC ELEMENT OR KEYBOARD	There is an unrecoverable error in either the logic element or the keyboard.
	PROBLEM IN KEYBOARD	There is an unrecoverable error in the keyboard.

Test mode

For detailed information, refer to the *IBM 3164 ASCII Color Display Station-Operator Reference and Problem Solving Guide*.

Select mode

For detailed information, refer to the section on "**Changing SELECT menu values**" in Chapter 4.

Define function mode

For detailed information, refer to the section on "**Defining Function keys**" in Chapter 4.

Change keys mode

For detailed information, refer to the section on "**Changing keyboard functions**" in Chapter 4.

Host message mode

When you press the Msg key, the symbols and characters in the operator information area are changed to a latest host message stored in the display station. A host message can contain up to 80 characters at a time and the latest message is always stored in the character buffer. When a host message is sent to your display station the first time, the bottom leftmost message presently on your screen starts to blink notifying you that a message has been sent from the host. You can look at the message by pressing the Msg key. The host message will be displayed in the operator information area. You can return to the normal operating condition by pressing the Msg key again. The host message will be stored in the character buffer.

This chapter tells you how to perform manual operations on the display station using specific examples.

Changing the SETUP menu values 4-2

Changing SELECT menu values 4-8

Defining Function keys 4-15

Changing keyboard functions 4-18

- Swapping the function of the Jump and Page keys
- Copying the function of the Print key onto the Break key
- Deleting the Local key
- Setting the keyboard to its default values
- Checking the current setting of the Del Ln key
- Changing the key caps

Chapter 4. Operations

Changing the SETUP menu values

When you want to change some operating conditions of your display, you can do so by using the Setup menu. To get the Setup menu, press the Setup key while holding down the Ctrl key. The default or the previously set values will appear. You can change the values by moving to any field using any cursor move key, the Tab keys, or the Return key and then by pressing the space bar. An alternate value will appear in that field. If you want to cancel the setup values or to exit from this menu, press the Setup key again.

```

                S E T U P   M E N U
-----
Press Space to select alternatives.
Machine Mode  IBM 3164
Operating Mode  BLOCK

                Main Port          Auxiliary Port
-----
Interface      RS-232C
Line Control   PRTS
Line Speed (bps) 9600              9600
Parity         ODD                ODD
Turnaround Character ETX
Stop Bit       1                  1
Word Length (bits) 7                7
Response Delay (ms) 100
Break Signal (ms) 500

Terminal ID: _____ Up to 20 alphanumeric
                           characters are allowed.

When all finished, press Send. Press Setup to quit.
-----
LOCAL
```

The values in the setup menu can also be changed by the Set Control commands from the host system. For more information on these commands, refer to "**Commands and responses**" in chapter 5.

The chart on the following page shows the fields with their values.

If you specify this field on the menu	and select this option	this will happen
Machine Mode	IBM 3164*	The display station operates in its original mode. It is compatible to the IBM 3163 mode.
	IBM 3101	The display station operates in the IBM 3101 emulation mode.
Operating Mode	ECHO	The display station operates in echo mode, and data entered from the keyboard is sent to the host system and transmitted back for display onto the screen in a conversational manner.
	CHAR	The display station operates in character mode and data entered from the keyboard is sent to the host system and at the same time "internally echoed" for display onto the screen.
	BLOCK*	The display station operates in block mode and the specified data area in the character buffer is sent to the host system when you press the Send key or the Read command is received from the host system.
Interface	RS-232C*	Selects the RS-232C interface to communicate with the host system.
	RS-422A	Selects the RS-422A interface to communicate with the host system. Applies only to Model 12s, which are equipped with both the RS-232C and RS-422A interface on the logic element.
Line Control	PRTS*	Uses the 'permanent request to send' (PRTS) signal to communicate with the host system.
	CRTS	Uses the 'controlled request to send' (CRTS) signal to communicate with the host system.
	IPRTS	Uses the 'induced permanent request to send' (IPRTS) signal to communicate with the host system.
Line Speed(bps)	50	Uses the 50 bps line speed to communicate with the host system.
	75	Uses the 75 bps line speed to communicate with the host system.
	110	Uses the 110 bps line speed to communicate with the host system.
	134.5	Uses the 134.5 bps line speed to communicate with the host system.
	150	Uses the 150 bps line speed to communicate with the host system.
	200	Uses the 200 bps line speed to communicate with the host system.
	300	Uses the 300 bps line speed to communicate with the host system.
	600	Uses the 600 bps line speed to communicate with the host system.
	1200	Uses the 1200 bps line speed to communicate with the host system.
	1800	Uses the 1800 bps line speed to communicate with the host system.
	2400	Uses the 2400 bps line speed to communicate with the host system.
	3600	Uses the 3600 bps line speed to communicate with the host system.
	4800	Uses the 4800 bps line speed to communicate with the host system.
	7200	Uses the 7200 bps line speed to communicate with the host system.
9600*	Uses the 9600 bps line speed to communicate with the host system.	
19200	Uses the 19200 bps line speed to communicate with the host system.	

Chapter 4. Operations

If you specify this field on the menu	and select this option	this will happen
Parity	ODD*	Selects the odd parity and is used together with the word length option to form the 7-bit or the 8-bit data with the odd parity bit.
	EVEN	Selects the even parity and is used together with the word length option to form the 7-bit or the 8-bit data with the even parity bit.
	MARK	Selects the mark parity and is used together with the word length option to form the 7-bit data with the mark parity bit.
	SPACE	Selects the space parity and is used together with the word length option to form the 7-bit data with the space parity bit.
	NO	Does not add a parity bit and is used together with the word length option to form the 7-bit or the 8-bit data with no parity bit.
Turnaround Character	ETX*	Selects the end of text (ETX) character as the line turnaround character, which is generated at the end of the data stream.
	EOT	Selects the end of transmission (EOT) character as the line turnaround character, which is generated at the end of the data stream.
	DC3	Selects the DC3 (transmission off-XOFF) character as the line turnaround character, which is generated at the end of the data stream.
	CR	Selects the carriage return (CR) character as the line turnaround character, which is generated at the end of the data stream.
Stop Bit	1*	Places a bit after a data word.
	2	Places two bits after a data word.
Word Length (bits)	7*	Selects seven bits as the data word length.
	8	Selects eight bits as the data word length.
Response Delay (ms)	0	Selects 0 milliseconds (no delay) as the time required for the host system to send back a response to the terminal.
	100*	Select 100 milliseconds as the time required for the host system to send back a response to the terminal.
Break Signal (ms)	170	Selects 170 milliseconds as the time required to send the 'break' signal to the host system when the Break key is pressed.
	500*	Selects 500 milliseconds as the time required to send the 'break' signal to the host system when the Break key is pressed.

Note: An asterisk (*) indicates the default values.

The following example shows how to change the line speed from 9600 to 1200 bps for the main port and the stop bit from 1 to 2 bits for the auxiliary port.

Note: Do not set the setup values as in the example give below; they are only examples.

Step 1. Make a copy of the **Setup Sheet** in Appendix A and write down all the changes you will be making in this example onto that sheet.



Step 2.

- a. Press and hold the **Ctrl** key; then press the **Setup** key to enter setup mode.

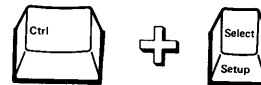
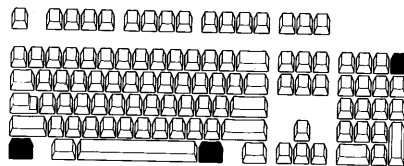

- b. The setup menu with the default or the previously defined values will appear on your screen.

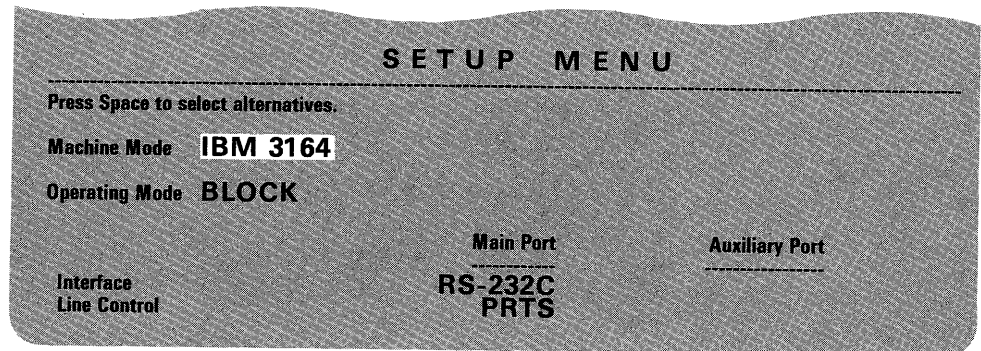

Chapter 4. Operations

Step 3.

- a. Using any cursor move key, tab key, or the Return key, move the box to **9600** of the line speed field under the main port column.

	Main Port	Auxiliary Port
Interface	RS-232C	
Line Control	PRTS	
Line Speed (bps)	9600	9600
Parity	ODD	ODD

- b. Press the space bar. The **9600** will change to the next value which is **19200**. Alternately press and release the space bar until **1200** appears.

	Main Port	Auxiliary Port
Interface	RS-232C	
Line Control	PRTS	
Line Speed (bps)	1200	9600
Parity	ODD	ODD

Step 4.

- a. Using any cursor move key, tab key, or the Return key, move the box to the **1** of the stop bit field under the auxiliary port column.

Line Speed (bps)	1200	9600
Parity	ODD	ODD
Turnaround Character	ETX	
Stop Bit	1	1
Word Length (bits)	7	7

- b. Press the space bar to change the **1** to **2**. Your screen should look like this.

Line Speed (bps)	1200	9600
Parity	ODD	ODD
Turnaround Character	ETX	
Stop Bit	1	2
Word Length (bits)	7	7

Step 5. If you have a terminal ID, you can key them in on this menu. The terminal ID can have up to 20 characters.

Stop Bit	1	2
Word Length (bits)	7	7
Response Delay (ms)	100	
Break Signal (ms)	500	

Terminal ID: _____ Up to 20 alphanumeric characters are allowed.

When all finished, press Send. Press Setup to quit.

LOCAL

Step 6. Press the **Send** key to store the new values in your display station and to exit the setup mode. Your screen will become blank. The new values will be stored in your logic element even if you switch off your display station.

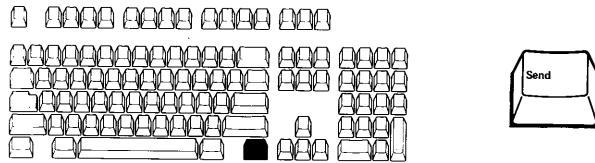

You have completed changing your setup conditions. Verify the values by looking at the setup menu again. Write down the new setup menu conditions onto the Setup Memo in the *IBM 3164 ASCII Color Display Station-Operator Reference and Problem Solving Guide*, which is stored in the drawer of the logic element.

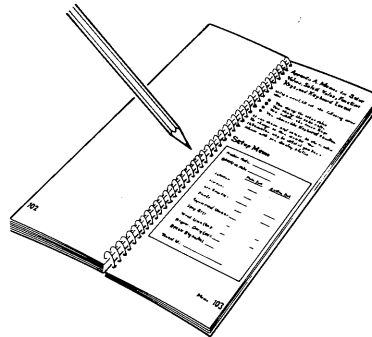

Chapter 4. Operations

Changing SELECT menu values

If you want to change some other operating conditions besides those on the Setup menu, you can do so using the Select menus 1, 2, and 3. Press the Select key, and the Select menu will appear at the bottom of the screen. The default or the previously set values will appear. Go to a field you want to change by using the Cursor Right (→) key and press the spacebar to get the value you want. If you want to cancel these values or to exit from this menu, press the Select key. These values can be changed even during an on-line operation.

The select values can also be changed by the Set Control command from the host system. For more information on these commands, refer to "Commands and responses" in chapter 5.

The figure below shows the Select menus 1, 2, and 3.

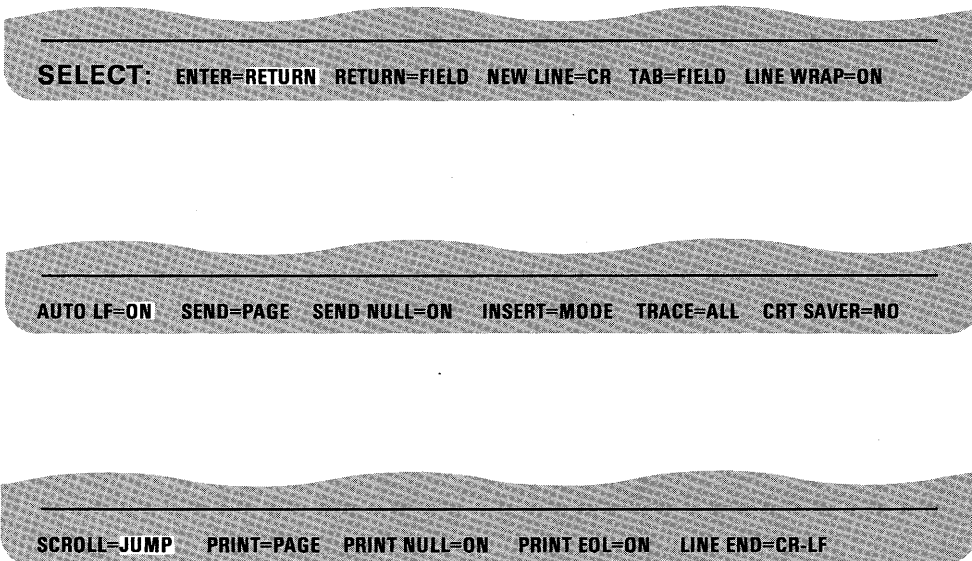

You can change these values also from the host system using the Set Control commands.

The chart on the following page shows the field with their values.

If you specify this field on menu 1	and select this option	this will happen
ENTER	RETURN*	The Enter key works as the Return key.
	SEND	The Enter key works as the Send key.
RETURN	FIELD*	The cursor moves to the next unprotected field when the Return key is pressed.
	NEW LINE	The New Line option functions when the Return key is pressed.
NEW LINE	CR*	The Return key generates the carriage return (CR) control. If this option is selected in character mode when CR is a line turnaround character, the Return key performs the carriage return and the line feed operations, but only the CR control character is sent to the host.
	CR-LF	The Return key generates the carriage return (CR) and the line feed (LF) control characters. If this option is selected in character or echo mode when CR is a line turnaround character, the Return key first generates the CR and LF control characters, and then the line turnaround occurs.
TAB	FIELD*	The column tab stops are ignored and the tab operation depends on the field attribute character positions.
	COLUMN	Tabs can be set at any character position in each viewport, regardless of the field attribute characters.
LINE WRAP	OFF	The cursor does not move to the first character position of the next line, but instead, it stays at the last character position. In this case, the audible alarm sounds whenever the operator enters data at the last character position. If additional characters are entered, they are transferred to the host system, and the displayed character in the last character position changes as each character is entered.
	ON*	The cursor moves to the first character position of the next line in the page after it reaches the last character location of the current line in the page. If the scroll option is also on, and if the cursor is at the last character position on the bottom line of an unformatted page, the page will scroll up and the cursor will move to the first character position of the newly created bottom line. If the scroll option is off, the cursor moves to the top of the page. This option is automatically set to on in block mode.

Note: An asterisk (*) indicates a default value.

Chapter 4. Operations

If you specify this field on menu 2	and select this option	this will happen
AUTO LF	ON*	Moves the cursor to the first character position of the next line when the carriage return (CR) key is pressed or the CR control character is received from the host system.
	OFF	Moves the cursor to the first character position of the current line. Therefore, if the new line function is desired, the host system must send the CR and LF control characters or they must be entered from the keyboard.
SEND	PAGE*	The content of the current page is sent to the host system when the Send key is pressed. The content of the current cursor line is sent to the host when the Send Line key is pressed.
	LINE	The content of the current cursor line is sent to the host system when the Send key is pressed. The content of the current page is sent to the host when the Send Line key is pressed.
SEND NULL	OFF	Trailing nulls are replaced with space characters and sent to the host system.
	ON*	Trailing nulls are not sent to the host system.
INSERT	MODE*	The terminal enters insert mode when the Insert key is pressed.
	SPACE	A blank is inserted when the Insert key is pressed.
TRACE	ALL*	Both the inbound data (data to the host system) and outbound data (data from the host system) of the main port are transferred to the auxiliary port without disturbing the communication with the host when the Trace key is pressed.
	RECEIVE	Only the outbound data (data from the host system) of the main port is transferred to the auxiliary port without disturbing the communication with the host when the Trace key is pressed.
	SEND	Only the inbound data (data to the host system) of the main port is transferred to the auxiliary port without disturbing the communication with the host when the Trace key is pressed.
CRT SAVER	NO*	Disables this function.
	5	The screen goes blank if there is no activity (no host or operator input) on the terminal for 5 minutes. When data is received from the host system or if a key is pressed, the cathode-ray tube (CRT) contents are displayed again without loss of previously input data.
	10	The screen goes blank if there is no activity (no host or operator input) on the terminal for 10 minutes. When data is received from the host system or if a key is pressed, the cathode-ray tube (CRT) contents are displayed again without loss of previously input data.
	15	The screen goes blank if there is no activity (no host or operator input) on the terminal for 15 minutes. When data is received from the host system or if a key is pressed, the cathode-ray tube (CRT) contents are displayed again without loss of previously input data.

Note: An asterisk (*) indicates a default value.

If you specify this field on menu 3	and select this option	this will happen
SCROLL	OFF	When the last character of the bottom line is entered, no lines move.
	JUMP*	When the last character of the bottom line is entered, all lines move up rapidly.
	SMOOTH	When the last character of the bottom line is entered, all lines move up slowly.
PRINT	PAGE*	The contents of the page are sent to the printer when the Print key is pressed.
	SCREEN	The contents of the screen are sent to the printer when the Print key is pressed.
	VIEWPORT	The contents of the viewport are sent to the printer when the Print key is pressed.
PRINT NULL	OFF	Trailing nulls are replaced with space characters and sent to the printer.
	ON*	Trailing nulls are not sent to the printer.
PRINT EOL	OFF	No line-end character is sent to the printer.
	ON*	When the printed line is equal to the width of the viewport (for Print Viewport), screen (for Print Screen), or page (for Print Page), the line-end character defined by the line end option is sent to the printer.
LINE END	CR-LF*	The carriage return (CR) and the line feed (LF) control characters are sent to the printer as the line-end character.
	CR	The carriage return (CR) control character is sent to the printer as the line-end character.

Note: An asterisk (*) indicates a default value.

Chapter 4. Operations

The following example shows how to change the send value from PAGE to LINE and the scroll value from SMOOTH to OFF.

Note: Do not set the select values as in the example given below; they are only examples.

Step 1. Make a copy of the **Select Sheet** in Appendix B and write down all the changes you will be making in this example onto that sheet.



Step 2.

- a. Press the **Select** key to enter select mode.



- b. Menu 1 with the default values will appear on the screen:



- c. Press the **Send** key to go to menu 2. The option you need (Send) is not on this menu.

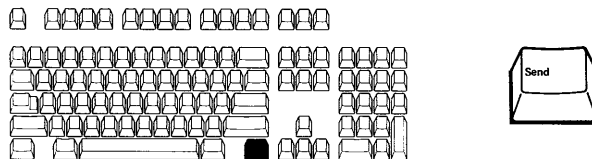

d. Menu 2 will appear on your screen:

AUTO LF=ON SEND=PAGE SEND NULL=ON INSERT=MODE TRACE=ALL CRT SAVER=NO

Step 3.

a. Using the cursor right or the tab key, move the box to **PAGE** of the send field.

AUTO LF=ON SEND=PAGE SEND NULL=ON INSERT=MODE TRACE=ALL CRT SAVER=NO

b. Press the space bar and **PAGE** will change to **LINE**.

AUTO LF=ON SEND=LINE SEND NULL=ON INSERT=MODE TRACE=ALL CRT SAVER=NO

Step 4.

a. Press the **Send** key to go to menu 3 since the next option you need (Scroll) is not on this menu.

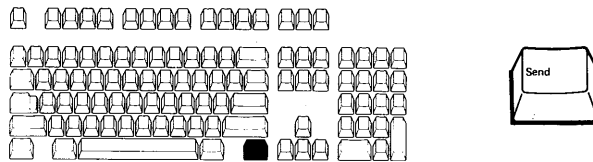

b. Menu 3 will appear on your screen:

SCROLL=JUMP PRINT=PAGE PRINT NULL=ON PRINT EOL=ON LINE END=CR-LF

Chapter 4. Operations

Step 5.

- a. Press the space bar. **JUMP** will change to **SMOOTH**

```
SCROLL=SMOOTH PRINT=PAGE PRINT NULL=ON PRINT EOL=ON LINE END=CR-LF
```

- b. Press the space bar again. **SMOOTH** will change to **OFF**

```
SCROLL=OFF PRINT=PAGE PRINT NULL=ON PRINT EOL=ON LINE END=CR-LF
```

Step 5. Press the **Send** key to store the new values in your display station and to exit the select mode. The new values will be stored in your logic element even if you switch off your display station.

Step 6. Press the **Select** key to exit from this select menu.

You have completed changing the select values. Verify the values by looking through each of the menus again. Write down the new select menu values onto the Select Memo in the *IBM 3164 ASCII Color Display Station-Operator Reference and Problem Solving Guide* which is stored in the drawer of the logic element.

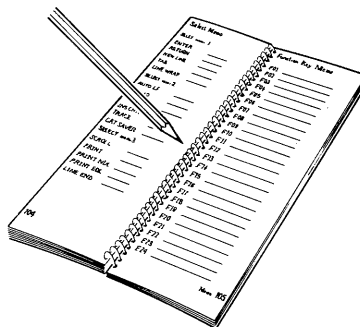

Defining Function keys

If you want to redefine the Function keys from the default or the previously set values, you can do so by using the Def F key. This function enables you to program the functions keys from your keyboard, and to perform your own applications.

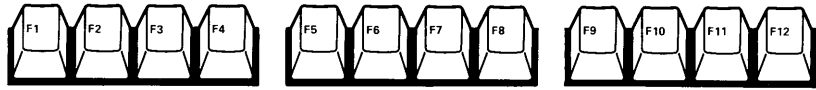

To enter define-function mode, press and hold the Ctrl key; then press the Def F key. The following Def F menu will appear on the bottom line.

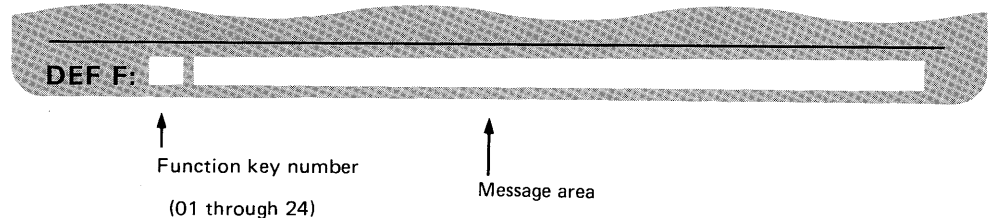

When you enter a function key number (1 through 24) and press the Send key, the default attention identifier (AID) value will be displayed in the message area and the word AID on the far right. For the AID values assigned to the respective Function keys, refer to Chapter 3, "**Function keys.**" You can replace the default AID values in the message area with any alphanumeric data or an ASCII control character, or any ESC sequence. A control character is keyed-in by holding down the Ctrl key and a certain alphanumeric key. Refer to page 5-11 to find out which key to press to get a desired control code. To reinstate the default AID values, press the Clear key.

The following are restrictions for input of characters into the message area:

1. A total of 256 characters can be input for the entire 24 function keys and the maximum input per key is 64 characters. If character inputs exceed 256, the audible alarm sounds and the cursor moves to the first position of the message area when the Send key is pressed. Then, only those characters which will be stored in that Function key will be displayed in the message area.
2. The ASCII control characters DC1 (XON) and DC3 (XOFF) are not allowed in a message during a pacing operation.
3. The ASCII control characters are displayed as graphic symbols as in transparent mode except the DLE symbol. One DLE symbol is displayed for each DLE key input instead of two as in transparent mode.
4. Incorrect ESC and DLE sequences may be keyed-in, since they will not be checked for correctness at this time. They will be checked when their functions are invoked by the keyboard and will be treated as errors.

Function keys can also be defined from the host system using the Load Programmable Function Key command. For more information on this command, refer to "**Commands and responses**" in Chapter 5.

Chapter 4. Operations

The following example shows you how to store a phrase "Dear Sir," using function key **20** and how to retrieve it.

Step 1.

- a. Press and hold the **Ctrl** key; then press the **Def F** key to enter define function mode.

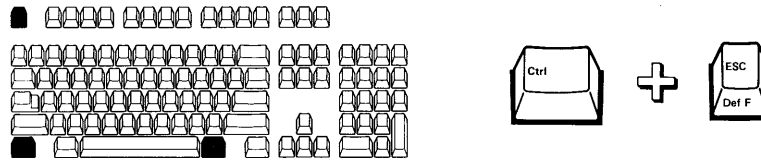

- b. The following menu will appear:

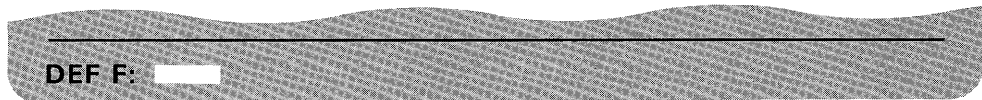

Step 2.

- a. Type the function key number **20** at the present cursor position and press the **Send** key.

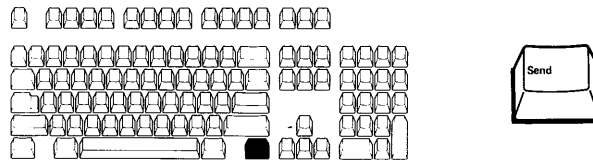

- b. The following menu will appear:

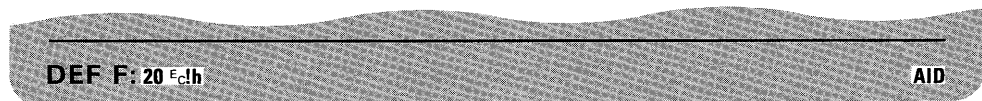

Note: If an AID format is displayed, it is accompanied by the word AID at the bottom right of the screen.

Step 3. Type **Dear Sir.**, and then the control character CR (carriage return), which is made by holding down the Ctrl key and pressing the M key (refer to page 5-11). Your screen should look like this.

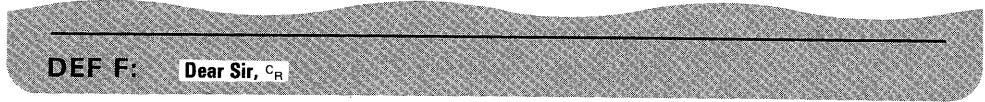

Step 4. Press the **Send** key to store the new value for F20. The menu disappears from the screen.

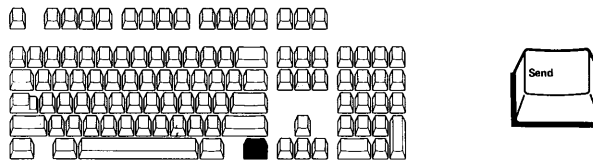

Step 5. Press and hold the **Ctrl** key; then press the **Def F** key to exit the define function mode and to return to normal operation.

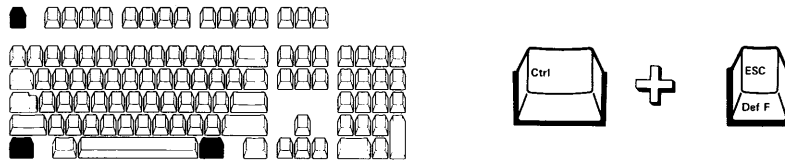

You have completed storing a phrase into the **F20** key. Verify if the phrase **Dear Sir**, was successfully stored by pressing the **F20 (Shift + F8)** key. Write down the new value of the function key onto the Function Key Memo in the *IBM 3164 ASCII Color Display Station-Operator Reference and Problem Solving Guide* which is stored in the drawer of the logic element.

Chapter 4. Operations

Changing keyboard functions

This section tells you how to change the function of some keys by using the **Change Keys** key. These keys have an upper-shift, a lower-shift, and a control-shift function which may be changed with any shift function of another key. In the initial default state before you start changing the functions, the keys with only one engraving on the top have the same upper-shift and lower-shift function and a control-shift function. An exception is the PF keys which have a different upper-shift (for example, PF13) and lower-shift (for example, PF1) function, and an empty control-shift function which may be defined later. The line drawing keys on the numeric keypad cannot be redefined.

You can also change the function of these keys from the host system using the Keyboard Layout Change commands. For more information on these commands, refer to **“Commands and responses”** in Chapter 5. This function enables you to:

- Swap the function of two keys
- Copy a function from one key to another
- Delete a function from the keyboard
- Set a default function
- Check the key IDs.

Shown below are the keys (unshaded) that can be redefined. To redefine a key, you must enter its ID and shift condition.

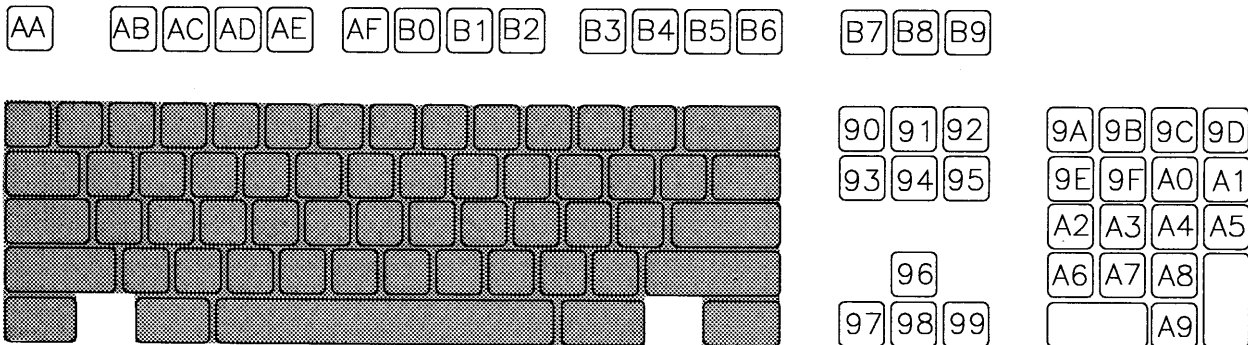

The shift conditions are:

- U: upper-shift state
- L: lower-shift state
- C: control-shift state

After you have changed their functions, go to the end of this section to find out how to change their keycaps. In most cases you will be changing the three shift functions of a key altogether which will require you to use the key cap labels for writing in the new names and also the transparent key caps. Make a copy of the Keyboard Layout Sheet in Appendix C so that you can write down the location of the keys you changed.

Read through the examples on the following pages to get a better idea of the keyboard modifying process.

Swapping the function of the Jump and Page keys

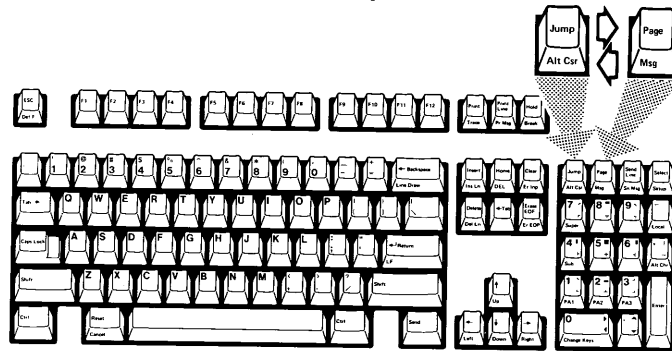

Step 1. Make a copy of the **Keyboard Layout Sheet** in Appendix C and write down all the changes you will be making in this example onto that sheet.

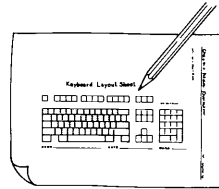

Step 2.

- a. Press and hold the **Ctrl** key; then press **Change Keys** to enter change keys mode.

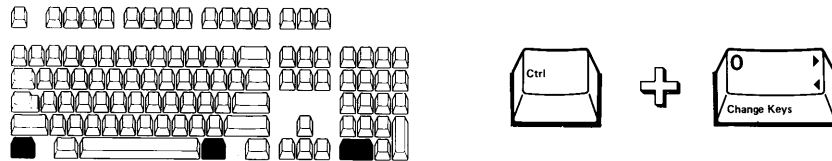

- b. The **CHANGE KEYS** menu will appear with the cursor on the far right.

CHANGE KEYS: Type No. and press Send. 1.SWAP 2.COPY 3.DELETE 4.DEFAULT 5.CHECK

Step 3.

- a. Type **1** at the present cursor position and press the **Send** key.

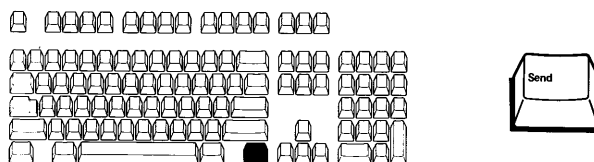

Chapter 4. Operations

b. The SWAP menu will appear:

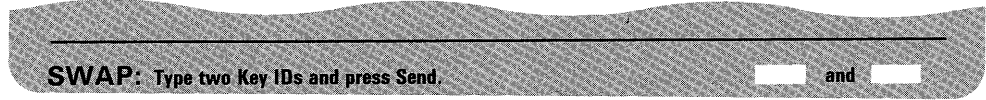

Step 4. Type **9A** and **L**, and **9B** and **L**. Refer to page 4-18 for the key IDs and shift conditions of the **Jump** and **Page** keys. The screen should look like this.

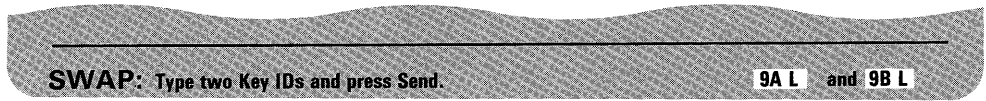

Step 5. Press the **Send** key to store this condition. It will be stored in your logic element even if you switch off your display station.

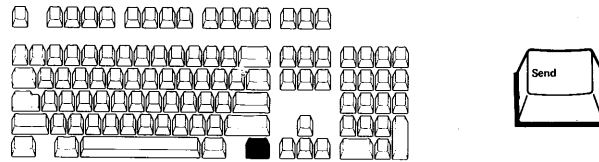

Step 6. Press and hold the **Ctrl** key; then press **Change Keys** to exit the SWAP menu and to return to the CHANGE KEYS menu.

Step 7. Press and hold the **Ctrl** key; then press **Change Keys** again to return to normal operation.

You have completed swapping the function of the **Jump** and the **Page** keys. Verify that you have successfully swapped the two functions by pressing these two keys, their functions should be performed. If you wish, you can go on to swap the **Atl Csr** and **Msg** functions by repeating the process again.

For changing the key caps, refer to page 4-28.

Copying the function of the Print key onto the Break key

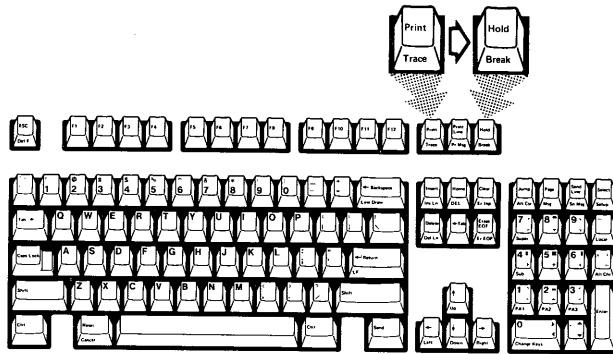

Step 1. Make a copy of the **Keyboard Layout Sheet** in Appendix C and write down all the changes you will be making in this example onto that sheet.

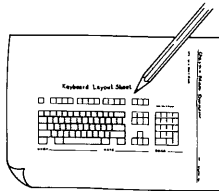

Step 2.

- a. Press and hold the **Ctrl** key; then press **Change Keys** to enter change keys mode.

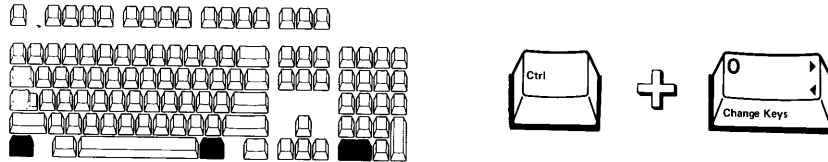

- b. The **CHANGE KEYS** menu will appear:

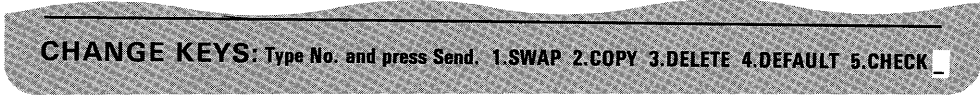

Step 3.

- a. Type **2** at the present cursor position and press the **Send** key.

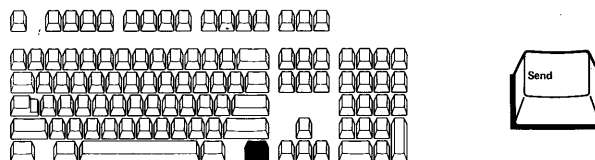

Chapter 4. Operations

b. The COPY menu will appear:

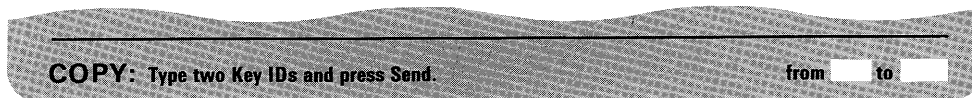

Step 4. Type **B7** and **L** and **B9** and **C**. For the key ID and the shift conditions of the **Print** and **Break** keys, refer to page 4-18. The screen should look like this.

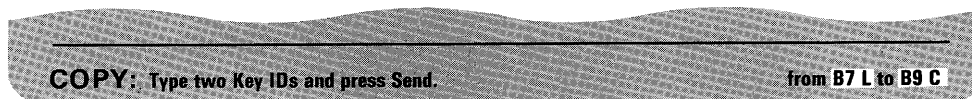

Step 5. Press the **Send** key to store this condition. It will be stored in the logic element even if you switch off your display station.

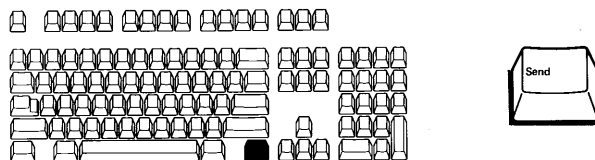

Step 6. Press and hold the **Ctrl** key; then press **Change Keys** to return to the CHANGE KEYS menu.

Step 7. Press and hold the **Ctrl** key; then press **Change Keys** to return to the normal operation.

You have completed copying the function of the **Print** key onto the **Break** key. Verify that you have successfully copied the function by pressing the **Break** key. The print function should be performed. If you wish, you can go on to copy the Trace function to the Hold key by repeating the process again.

For changing the key caps, refer to page 4-28.

Deleting the Local key

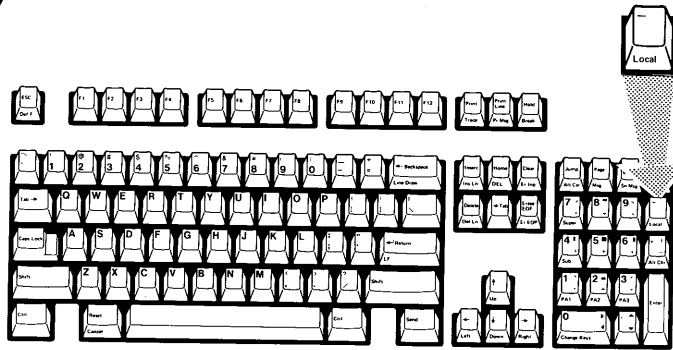

Step 1. Make a copy of the **Keyboard Layout Sheet** in Appendix C and write down all the changes you will be making in this example onto that sheet.

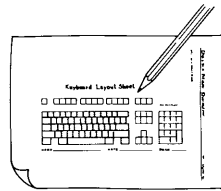

Step 2.

- a. Press and hold the **Ctrl** key; then press **Change Keys** to enter change keys mode.

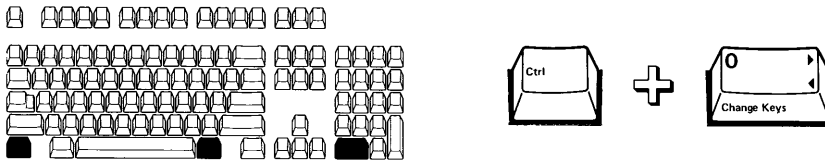

- b. The **CHANGE KEYS** menu will appear:

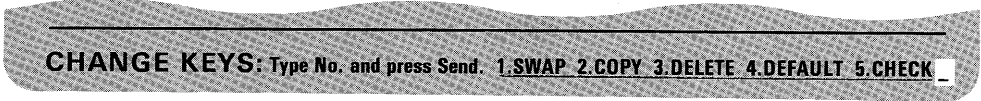

Step 3.

- a. Type **3** at the present cursor position and press the **Send** key.

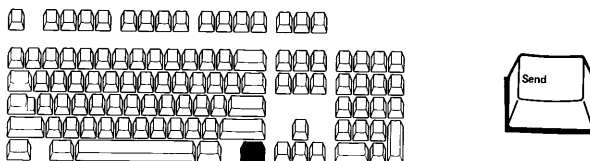

Chapter 4. Operations

b. The DELETE menu will appear:



DELETE: Type Key ID and press Send.

Step 4. Type **A1** and **C**. Refer to 4-18 for the key ID and the shift conditions of the **Local** key. The screen should look like this.



DELETE: Type Key ID and press Send.

A1 C

Step 5. Press the **Send** key to store this condition. It will be stored in your logic element even if you switch off your display station.

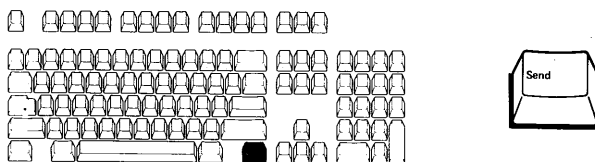

Step 6. Press and hold the **Ctrl** key; then press **Change Keys** to exit the DELETE menu and to return to the CHANGE KEYS menu.

Step 7. Press and hold the **Ctrl** key; then press **Change Keys** again to return to normal operation.

You have deleted the function of the **Local** key. Verify that you have successfully deleted the function by pressing the **Local** key. Nothing should occur. If you wish, you can go on to delete the dash (-) function by repeating the process again.

For changing the key caps, refer to page 4-28.

Setting the keyboard to its default values

Step 1.

- a. Press and hold the **Ctrl** key; then press **Change Keys** to enter change keys mode.

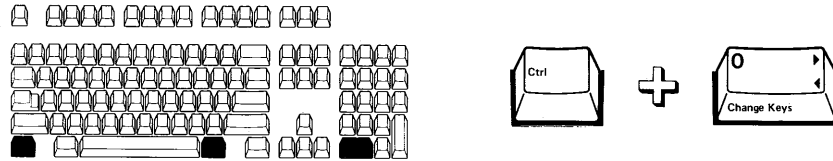

- b. The CHANGE KEYS menu will appear:

CHANGE KEYS: Type No. and press Send. 1.SWAP 2.COPY 3.DELETE 4.DEFAULT 5.CHECK _

Step 2.

- a. Type **4** at the present cursor position and press the **Send** key.

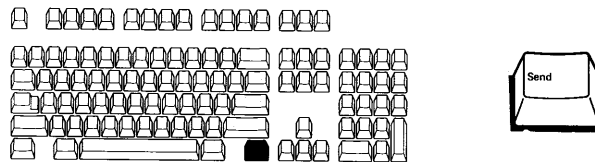

- b. The DEFAULT menu will appear:

DEFAULT: To initialize keys, press Send.

Step 3.

- a. Press the **Send** key to change the keyboard to the default settings.
- b. The CHANGE KEYS menu will appear.

Step 4. Press and hold the **Ctrl** key; then press **Change Keys** to return to normal operation.

You have completed setting the keys to the default values. Verify by pressing any key. Their original functions should be performed. For changing the key caps, refer to page 4-28.

Chapter 4. Operations

Checking the current setting of the Del Ln key

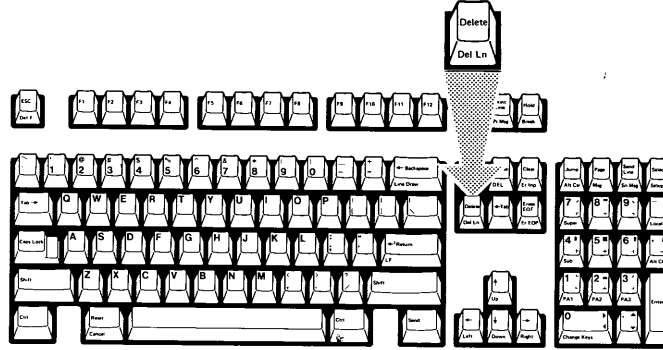

Step 1.

- a. Press and hold the **Ctrl** key; then press **Change Keys** to enter change keys mode.

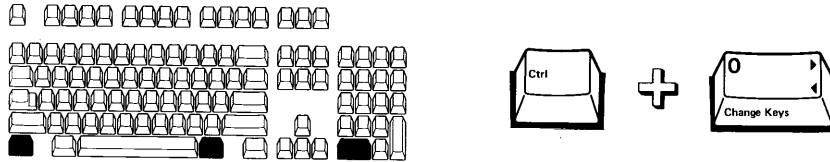

- b. The **CHANGE KEYS** menu will appear:

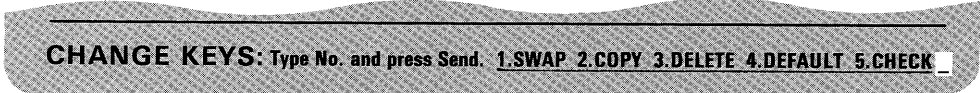

Step 2.

- a. Type **5** at the present cursor position and press the **Send** key.

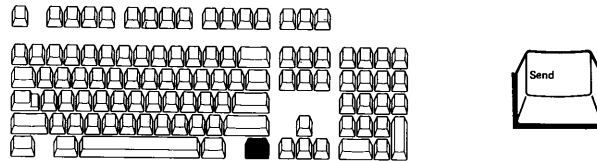

- b. The **CHECK** menu will appear:

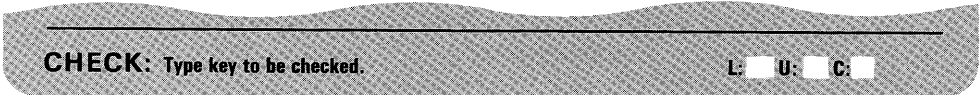

c. Press and hold the **Ctrl** key; then press the **Del Ln** key.

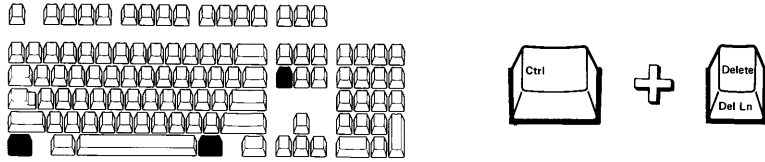

d. The key ID and the shift condition of the **Del Ln** key will be displayed on the far right. Check this value with the value on page 4-18.

CHECK: Type key to be checked.

L:93 L U:93 L C: 93 C

Step 3. Press **Change Keys**. The CHANGE KEYS menu will appear.

Step 4. Press and hold the **Ctrl** key; then press **Change Keys** to return to normal operation.

You have completed checking the current setting of the **Del Ln** key.

Chapter 4. Operations

Changing the key caps

Step 1. Refer to the **Keyboard Layout Sheet** in Appendix C, and if required, remove the key caps using the key-cap removal tool.

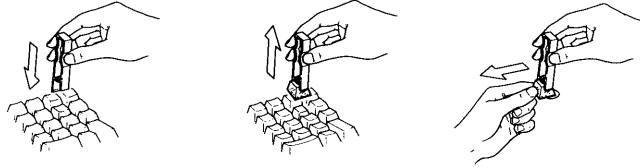

Step 2. Write the new function names for the keys you changed on the paper insert. This optional paper insert should have been ordered beforehand.

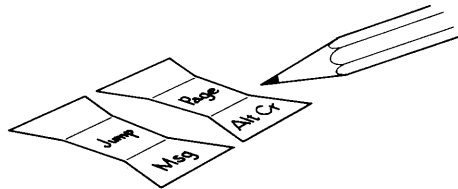

Step 3. Insert the paper insert into the clear key cap.

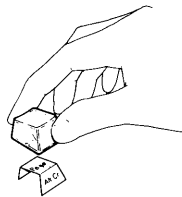

Step 4. Install the new key caps. Save the old key caps, in case you change your keyboard back to the original layout.

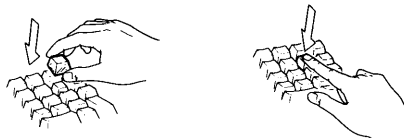

Step 5. Write down the changes you made onto the Keyboard Layout Memo in the *IBM 3164 ASCII Color Display Station-Operator Reference and Problem Solving Guide* which is stored in the drawer of the logic element.

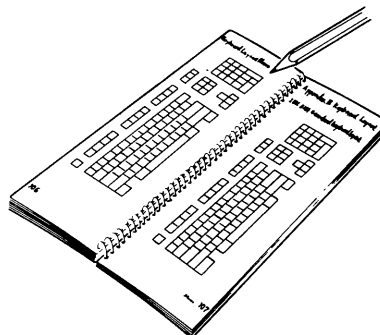

Chapter 5. Programming considerations

This chapter tells you how to program from the host system. It also includes some programming samples.

Data stream 5-2

- To and from the host
- To the host
- To the printer
- Passthrough operation
- Text format (main port)
- Data conversion (main port)
- Text format (auxiliary port)

Machine modes 5-10

Control characters 5-11

- DLE sequence
- ESC sequence

Commands and responses 5-16

- Using the Set Control commands
- Using the Viewport/Window/Partition/Page Control commands
- Using the Attribute Control commands
- Using the Cursor Address and Buffer Address commands
- Using the Keyboard Control commands

Chapter 5. Programming considerations

Data stream

This section defines the data stream used by the IBM 3164 to communicate with the host system. The IBM 3164 data stream consists of data characters and control characters. Data characters are the ASCII codes from X'21' to X'7E' and are used to represent messages or text. Control characters are the codes from X'00' to X'20' and X'7F'. (Refer to the **ASCII Line Code Table** on page 5-79.) The control characters may be used alone or with other control or data characters to perform multiple functions; such as in the DLE sequence (DLE.EOT, DLE.STX, DLE.ETX, DLE.DC2, or DLE.DC4) or in the ESC sequence as commands/responses.

To and from the host

Each character consists of 7- or 8-bit codes depending on which Word Length Option you selected.

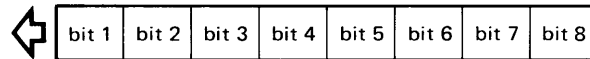
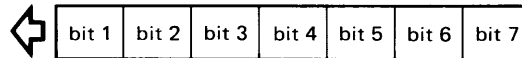

Each character has a parity bit at the end whose characteristics (ODD, EVEN, SPACE, MARK, or None) are selected by the Parity option. If you choose the None option, the character will not have a parity bit.

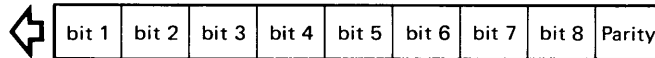
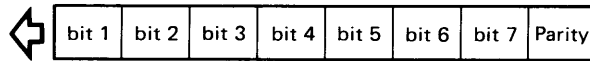

In addition to the parity bit, the data has one start bit and one or two stop bits which can be selected as an option.

The IBM 3164 samples the data bits until the stop bit (or bits) is received.

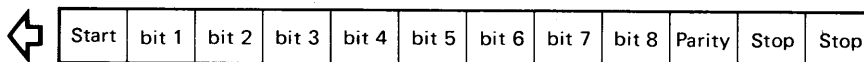
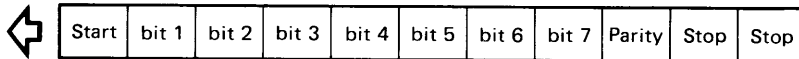
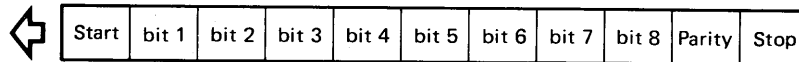
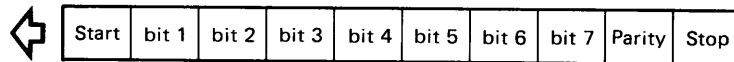

To the host

In character mode, the start bit does not always immediately follow the stop bit of the previously sent character. During this idle time between the stop bit and the start bit, the telecommunication line is held at mark-signal level.

In block mode, the data entered and stored in the character buffer is transferred to the host system in continuous form when a Send (Send, Sn Msg, or Send Line) key is pressed, or the Read Buffer command is received. The start bit immediately follows the stop bit of the transferred character.

To the printer

The data stream going to the printer is almost the same as the one to the host, however some characters are handled differently.

In normal mode, the null characters, a send mark, field attribute characters, error symbols, and non-displayable field characters are converted to space characters. The characters in a double height line are transferred in the same way as those in a single height line; handled as one line. The characters in the double width line are transferred each with a space character.

In both formatted and unformatted modes, trailing nulls and null characters that are followed by End-of-Line (EOL) are suppressed when the Print Null option is on.

In a print operation, the CR.LF character and DEL are automatically generated at the end of each line. The number of CR/CR.LF characters are specified by the Line End option while the number of DEL characters are specified by the Time Fill option of the Set Control 7 command.

The End-of-Line (EOL) and time fill character sequence is as follows:

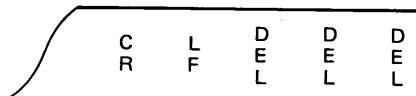

Chapter 5. Programming considerations

Passthrough operation

The IBM 3164 has a capability to by-pass data sent from a host system to an auxiliary device (outbound data) and to by-pass data sent from an auxiliary device to a host system (inbound data) by using the Auxiliary Input Data option of the Set Control 6 command. This is called a passthrough function and to use it, the word lengths on the main and the auxiliary ports should be set to the same value. The figure below shows the concept of the outbound and the inbound passthrough operation.

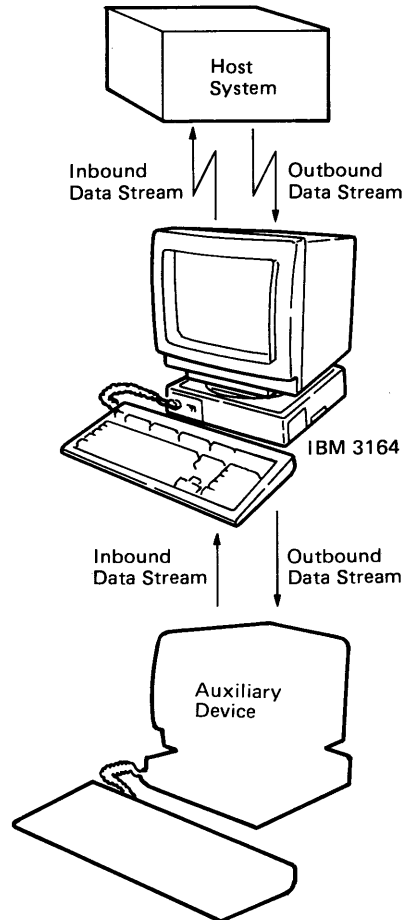

The IBM 3164 has a header/trailer counter for controlling the passthrough data stream. When the counter detects a first header (DLE.DC2) in the outbound data stream, it deletes the header and sets the counter to 1. It then passes the following data block which may contain headers and trailers (DLE.DC4) to an auxiliary device, increasing the counter number by 1 each time it detects a header and decreasing by 1 each time it detects a trailer. The IBM 3164 stops the data transmission to an auxiliary device when the register number becomes 0. The header/trailer counter also checks for double entry DLE characters in the outbound data stream and automatically deletes every second DLE character it encounters. Consequently, to send a DLE character to the first auxiliary device, two DLE characters must be sent from the host in the passthrough data block and four DLE characters for a second auxiliary device.

When the IBM 3164 receives an inbound data stream from an auxiliary device, the header/trailer counter does exactly the opposite of the above; it adds a header and a trailer before sending the data block to the host and also adds a DLE character after every DLE character.

The figure below shows the concept of an outbound passthrough operation.

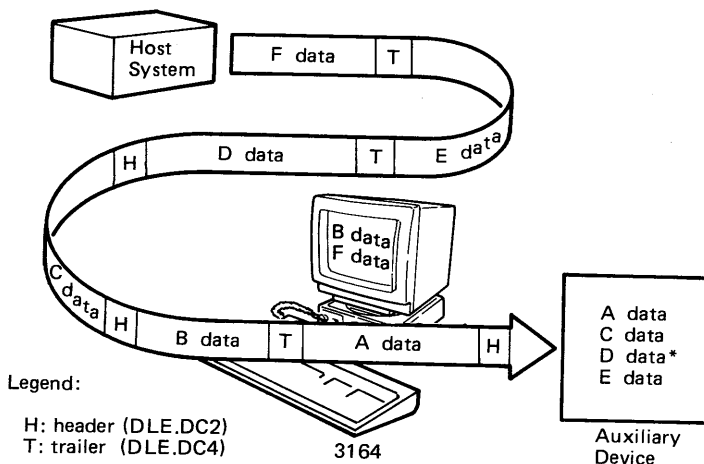

Note: If the auxiliary device has a passthrough capability, the D data is passed to a lower auxiliary device.

Text format (main port)

The IBM 3164 sends either of the following fields to the host:

- A modified field with MDT on
- An unprotected field
- All fields.

Which type of field will be transmitted to the host depends on the "field data transmission mode" set by the host command. At power-on reset (POR) this mode is set to the default mode which is the "modified field data transmission" mode. Then the fields with the MDT bit set to on will be sent to the host. If this mode is changed to the "unprotected field data transmission" mode by the Enable Unprotected Field Data Transmission command issued by the host, then all the unprotected fields will be sent. The Disable Unprotected Field Data Transmission command must be issued by the host system to set the IBM 3164 to the default (modified field data transmission) mode again. The Read All command issued by the host sends all fields to the host.

If the transmission of character attributes is enabled, the Set Character Attribute response is sent to the host prior to the affected character whenever a character attribute is changed.

Chapter 5. Programming considerations

The following table shows the handling of attributes in the inbound data stream.

Attribute	Read All		Read/Send	
	Formatted	Unformatted	Formatted	Unformatted
Field	Supported	Not applicable	Only MDT on or unprotected field	Not applicable
Character	Supported	Supported	Supported	Supported
Line	Not supported	Supported	Not supported	Supported

Notes:

1. All attributes are effective in the outbound data stream.
2. In the case of the read all operation, all data is sent to the host.

In an unformatted page, line attributes (except SHSW) are sent to the host at the beginning of each line data and the following apply:

- For double-height lines (DHSW or DHDW), the two lines which occupy the double-height characters in the buffer/viewport are sent as one line in the inbound data stream.
- For double-width lines (SHDW or DHDW), characters on the right hand side not visible in the page are not sent to the host as part of line data except transmission by the Read All command.

In a formatted page the following apply:

- Line attributes are not included in the inbound data stream since only the host program can write the line attributes and since the line attributes cannot be moved by scrolling.
- The field data transmitted to the host depends on the field data transmission mode.

Field data in modified field data transmission mode looks like this:

(X) SBA	Field Characters
---------	------------------

The (Extended) Set Buffer Address (X) SBA response specifies the buffer address of the first character in the modified field. If the row or column address is greater than 95, the XSBA format is used instead of SBA. The field characters are generated from the field according to the data-conversion rule. If the field has only null characters and the Null Suppress option is on, no field characters are sent.

Field data in unprotected field data transmission mode looks like this:

SFA	Field Characters
-----	------------------

The Set Field Attribute (SFA) response specifies the field attribute. The field characters are generated from the field according to the data-conversion rule. If the field has only null characters and the Null Suppress option is on, no field characters are sent. All CA's are also sent.

With the Null Suppress option off in an unformatted page, the format of a send/read page looks like this:

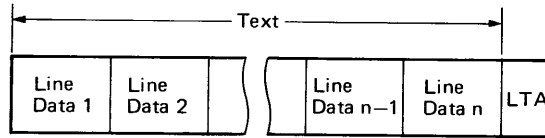

Note: Line data n is generated from the n th line in the page according to the data-conversion rule on page 5-9.

With the Null Suppress option on in an unformatted page, the page format looks like this:

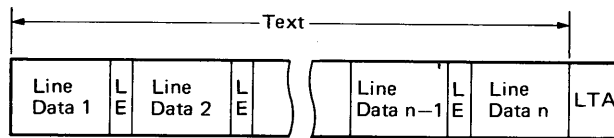

Notes:

1. Line data n is generated from the n th line in the current page according to the data-conversion rule on page 5-9.
2. The line end (LE) character(s) will be:
 - CR if the LTA option is not CR and the Auto LF is on
 - CR.LF if the LTA option is not CR and the Auto LF is off
 - RS if the LTA option is CR.
3. Even if all data in the line are suppressed, the line-end character associated with the suppressed line is generated.

For a formatted page, the send/read page looks like this:

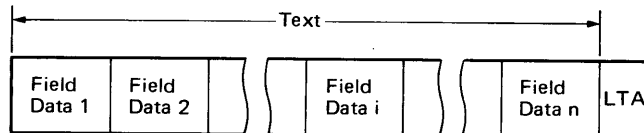

If the last field wraps from the last character position to the first character position in the page, the first data in the page is sent as part of the last field.

With the Null Suppress option off in an unformatted page, the send/read message format looks like this:

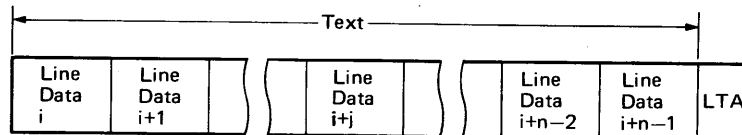

With the Null Suppress option on in an unformatted page, the send/read message format looks like this:

Chapter 5. Programming considerations

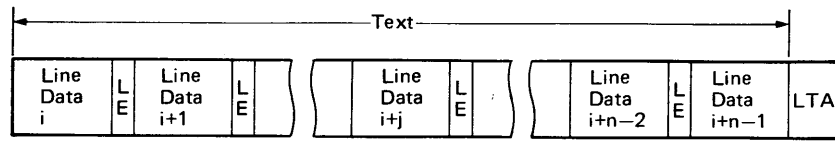

Notes:

1. The send mark is located in the $(i - 1)$ -th line and there are n number of lines between the send mark and the cursor.
2. Line data $i + j$ is generated from the $(i + j)$ -th line (if there are no double-height lines) on the screen according to the data-conversion rule on page 5-9.
3. The line end (LE) character(s) will be:
 - CR if the LTA option is not CR and the Auto LF option is on
 - CR.LF if the LTA option is not CR and the Auto LF option is off
 - RS if the LTA option is CR.

The send/read message format for a formatted page looks like this:

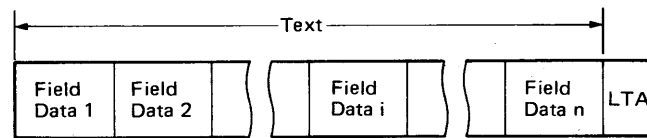

Note: The field data has the same format as the Send/Read Page data stream.

The send/read line format looks like this for the unformatted page:

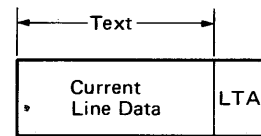

The send/read line format looks like this for the formatted page:

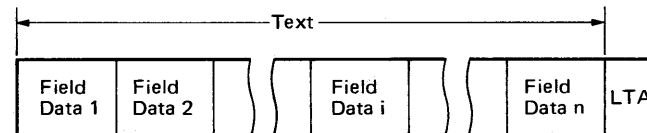

Note: The field data has the same format as the send/read page data stream.

When the Read Field command is received in the unformatted page, the display station performs the same function as the Send Line command.

The read field format for the formatted page looks like this:

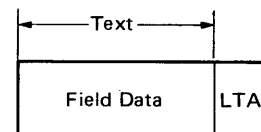

Note: The field data has the same format as the send/read page data stream.

The read all format for the unformatted page works like in the following way. When the Read All command is received in the unformatted page, the display station performs the same function as the Send/Read Page command. In this case, character attributes are always sent to the host.

The read all format for the formatted page looks like this:

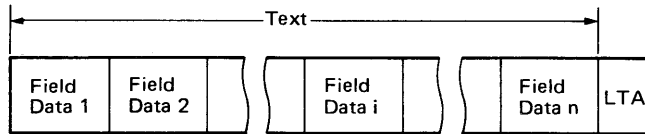

The data is sent from the first character position in the page, even if the field wraps from the last character position to the first character position in the page. As a result, the first field data does not include the SFA response.

Data conversion (main port)

All graphic characters are transmitted to the host without data conversion. Whenever a graphic character stored in a character set different from that of the previously transmitted character is encountered, the Select G0/G1 response and/or the SI/SO control character is applied just prior to sending that graphic character.

All ASCII control characters (except Null) are sent to the host without data conversion. If the Null Suppress option is on, the trailing null characters are suppressed and other nulls are converted to space characters before transmission. If the Null Suppress option is off, all nulls are converted to space characters and then transmitted to the host.

A field attribute character is sent to the host in the format of the Set Field Attribute response.

A character attribute is sent in the format of the Set Character Attribute response.

A line attribute is sent to the host in the format of the Set SHDW/DHSW/DHDW response.

An error symbol is converted to a space character and the send mark (⌘) is treated as a null character.

Text format (auxiliary port)

When a Print key is pressed or a Print (Print Viewport/Screen/Page/Message/Line) command is received, the ASCII graphic characters, subscripts, superscripts, line-draw, and alternate characters are sent to the auxiliary port without data conversion. The field-attribute characters and the characters in the non-display fields are converted to space characters. The send mark, error symbol, and null characters are also converted to space characters.

Chapter 5. Programming considerations

Machine modes

In its original mode, the IBM 3164 operates in the Default Color mode which is compatible with the IBM 3163. You can change between the Default Color mode and the Program Color mode by using the Set Control 2 command. Program Color mode supports the attributes for eight colors. The IBM 3164 returns to the Default Color mode whenever there is a power-on-reset (POR) sequence or when you return from the IBM 3101 mode to the IBM 3164 mode using the Set Control 1 command.

A POR sequence is performed under any of the following conditions:

- Power on
- The terminal exits from the test mode or from the setup mode
- The Reset-to-Initial-State (RIS) command is received from the host
- A parameter (ECHO, CHAR, BLOCK, Machine mode) is changed by the Set Control 1 command.

At power-on, the POR sequence together with the self diagnostic test takes about 5 seconds and the DTR signal on the main port stays off during this period. After every POR sequence, data in the various buffers are cleared and the terminal is reset to the default state.

As mentioned earlier, the IBM 3164 can also emulate the IBM 3101 mode by specifying the IBM 3101 mode using the Set Control 1 command or the setup menu.

Control characters

The following section describes the function of the control characters.

Ctrl + Keys	ASCII Control Characters	Meaning	Character Displayed	Description
2	NUL	Null		Ignored (see Enable/Disable Write Null commands)
A	SOH	Start of Header	S H	Ignored
B	STX	Start of Text	S X	Enters transparent mode (DLE sequence)
C	ETX	End of Text	E X	Exits transparent mode (DLE Sequence) or works as a line turnaround (LTA)
D	EOT	End of Transmission	E T	Works as an LTA or mandatory disconnect (DLE Sequence)
E	ENQ	Enquiry	E Q	Ignored
F	ACK	Acknowledge	A K	Acknowledges good LRC
G	BEL	Bell	B L	Causes the audible alarm to sound
H	BS	Backspace	B S	Causes the cursor to move left one position
I	HT	Horizontal Tab	H T	Causes the cursor to move to the next tab stop position
J	LF	Line Feed	L F	Causes the cursor to move to the next lower line
K	VT	Vertical Tab	V T	Causes the cursor to move to the the lower line
L	FF	Form Feed	F F	Causes the erase input function to be performed if SCROLL is off and moves the cursor to the next lower line if SCROLL is on
M	CR	Carriage Return	C R	Causes the cursor to move to the first character position of the current line or the next lower line. or works as LTA.
N	SO	Shift Out	S O	Specifies the character set (U.S. ASCII, special graphics, and the alternate character) to be shifted in and out of the G0 and G1 spaces. In the data transmission of G1, the characters will be sandwiched between SO and SI.
O	SI	Shift In	S I	

Chapter 5. Programming considerations

Ctrl + Keys	ASCII Control Characters	Meaning	Character Displayed	Description
P	DLE	Date Link Escape	D L	Changes the meaning of the following characters: EOT, STX, ETX, DC2, DC4. The first character of the DLE sequence
Q	DC1	Device Control 1	D 1	Restarts transmission for pacing
R	DC2	Device Control 2	D 2	Begins passthrough data stream (DLE sequence)
S	DC3	Device Control 3	D 3	Stops transmission for pacing or works as LTA
T	DC4	Device Control 4	D 4	Terminates passthrough data stream (DLE sequence)
U	NAK	Negative Acknowledge	N K	Negative acknowledge of bad LRC
V	SYN	Synchronous	S Y	Ignored
W	ETB	End of Transmission Block	E B	Ignored
X	CAN	Cancel	C N	Ignored
Y	EM	End of Medium	E M	Ignored
Z	SUB	Substitute	S B	Ignored
3	ESC	Escape	E C	Used with other keys to perform specific functions
4	FS	File Separator	F S	Ignored
5	GS	Group Separator	G S	Ignored
6	RS	Record Separator	R S	In the send/read operation, indicates the end of a line for turnaround character character.
7	US	Unit Separator	U S	Ignored
8	DEL	Delete	☒	Ignored

DLE sequence

The following data link escape (DLE) sequences are available in order to control the display station:

- DLE.EOT Mandatory disconnect
- DLE.STX Enter transparent mode
- DLE.ETX Exit transparent mode
- DLE.DC2 Begin passthrough data stream
- DLE.DC4 Terminate passthrough data stream.

These sequences may be generated from the host system or from the keyboard. If transparent mode is inhibited, the DLE.STX sequence from the keyboard causes the audible alarm to sound.

The 'mandatory disconnect' (DLE.EOT) sequence is used only on a switched communication network to initiate a disconnect. This sequence causes the display station and the host system to terminate and disconnect. When the display station receives or generates the DLE.EOT sequence, the following functions are performed.

1. The DTR signal is turned off.
2. The display station waits for 500 milliseconds.
3. The DTR signal is turned on again.

When the 'enter transparent mode' (DLE.STX) sequence is received, the display station enters the transparent mode, where all ASCII characters including control codes are displayed as symbols in the viewport.

The DLE character is displayed only if the operator presses the DLE key twice or if the host program sends two successive DLE characters to the display station.

When the 'exit transparent mode' (DLE.ETX) sequence is received, the display station exits transparent mode and all ASCII control characters disappear from the viewport.

The 'begin passthrough data stream' (DLE.DC2) sequence is used to indicate the beginning of a passthrough data stream.

The 'terminate passthrough data stream' (DLE.DC4) is used to terminate the passthrough data stream.

Chapter 5. Programming considerations

ESC sequence

Escape sequences are used to form commands and responses in order to control the conditions and functions of the display station. These sequences may be generated from the host system or from the keyboard.

The following figure illustrates the general rule of command processing.

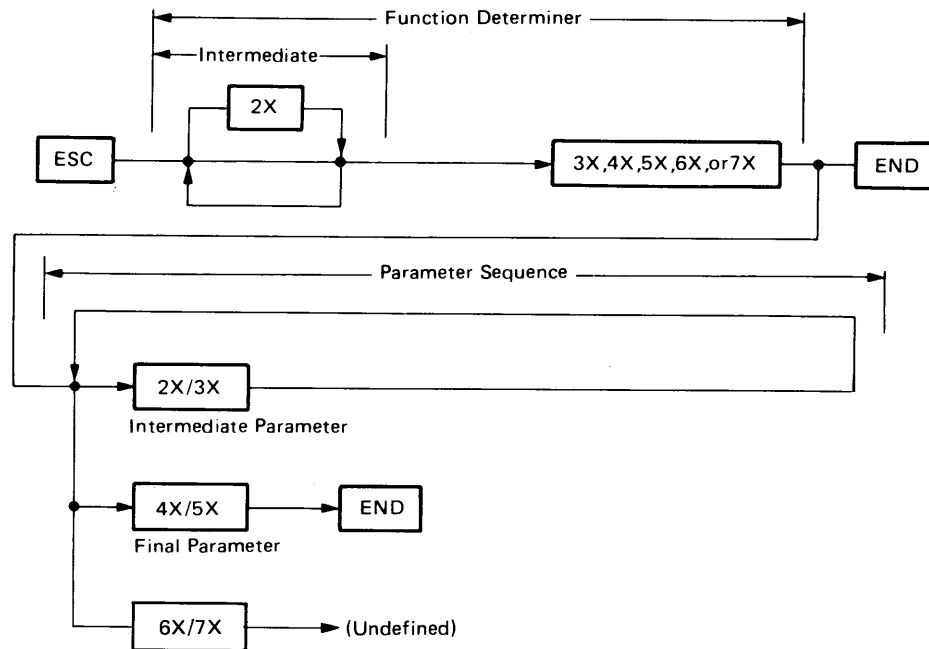

Legend: 2X : X'20' thru X'2F'
: :
: :
6X : X'60' thru X'6F'
7X : X'70' thru X'7E'

Note: Bit positions comply with ASCII notations; that is bit 7 being the highest-order bit.

Intermediate parameters are data which specify certain values and are used between the ESC control character and the final parameter and have the following format.

Bit 7: Always 0
6: Always 1
5: }
4: } These five bits are used
3: } to represent a parameter.
2: }
1: }

A final parameter has the following format:

Bit 7: Always 1
6: Always 0
5: }
4: } These five bits are used
3: } to represent a parameter.
2: }
1: }

Parameters can be truncated in the middle of a parameter sequence by specifying a final parameter value.

If a wrong escape sequence format is specified, the display station will detect that command and will not process it. The following formatting errors can be detected:

- An unauthorized final or intermediate character (undefined command).
- An undefined parameter or an incorrect length (invalid parameter).
- An undefined command in a specific mode (inapplicable command).

When the display station receives an undefined command or detects an invalid parameter, it displays **HOST PROG WRONG**. If the Read Status command is specified in the host application, this command error is reported back to the host system.

Chapter 5. Programming considerations

Commands and responses

Commands are used to control the conditions and functions of the display station. Some commands require responses to the host while some require parameters after the ESC sequence. The following section describes the commands and responses used by the IBM 3164.

Type	No.	Name	Supported by
Set/Read Control	1	Set/Read Control 1 Command/Response	H
	2	Set/Read Control 2 Command/Response	H
	3	Set/Read Control 3 Command/Response	H
	4	Set/Read Control 4 Command/Response	H
	5	Set/Read Control 5 Command/Response	H
	6	Set/Read Control 6 Command/Response	H
	7	Set/Read Control 7 Command/Response	H
Viewport/Window/Page Control	8	Create Viewport Command	H
	9	Create Partition/Page Command	H
	10	Select Host Partition Command/Response	H
	11	Select Host Page Command/Response	H
	12	Select Active Partition Command/Response	H
	13	Select Active Page Command/Response	H
	14	Jump Partition Command/Response	HK
	15	Jump Page Command/Response	HK
	16	Set Window Position Command	H
	17	Window Up Command/Response	HK
	18	Window Down Command/Response	HK
	19	Window Right Command/Response	HK
	20	Window Left Command/Response	HK
Attribute Control	21	Set Field Attribute Command/Response	HKB
	22	Set Character Attribute Command/Response	HK
	23	Enable CA Transmission Command	H
	24	Disable CA Transmission Command	H
	25	Reset Character Attribute Command	HK
	26	Set Single Height Single Width Command/Response	H
	27	Set Single Height Double Width Command/Response	H
	28	Set Double Width Single Width Command/Response	H
	29	Set Double Height Double Width Command/Response	H
Print Control	30	Print Viewport Command	H
	31	Print Screen Command	H
	32	Print Page Command	H
	33	Print Message Command	H
	34	Print Line Command	H
Erase/Clear	35	Erase EOL/F Command/Response	HK
	36	Erase Input Command/Response	HK
	37	Erase EOS Command/Response	HK
	38	Clear Page Command/Response	HK
	39	Clear Partition Command	HK
	40	Clear All Command	HK
Insert/Delete	41	Insert Line Commands/Responses	HK
	42	Delete Line Command/Response	HK
	43	Insert Character Command/Response	HK
	44	Delete Character Command/Response	HK

Type	No.	Name	Supported by
Tab Control	45	Set Column Tab Command	HK
	46	Clear Column Tab Command	HK
	47	Clear All Tabs Command	HK
	48	Back Tab Command/Response	HK
Cursor Address/Buffer Address Move	49	Set Buffer Address Command/Response	H
	50	Extended Set Buffer Address Command/Response	H
	51	Reset Buffer Address Mode Command	H
	52	Set Cursor Address Command/Response	H
	53	Extended Set Cursor Address Command/Response	H
	54	Cursor Up/Down/Right/Left Command/Response	HK
	55	Cursor Home Command/Response	HK
	56	Next Line Command	HK
	57	Index Command	HK
	58	Reverse Index Command	HK
	59	Insert Cursor Command	H
Read	60	Read Status Command/Response	H
	61	Read Model Command/Response	H
	62	Read Terminal ID Command and Response	H
	63	Read Cursor Address Command	H
	64	Enable Unprotected Field Data Transmission Command	H
	65	Disable Unprotected Field Data Transmission Command	H
	66	Read Page Command and Send AID	H
	67	Read Message Command and Send Message AID	H
	68	Read Line Command and Send Line AID	H
	69	Read Field Command	H
	70	Read All Command	H
Keyboard Control	71	Load Programmable Function Key Command	H
	72	Set Default Function Key Command	H
	73	Set All Default Function Keys Command	H
	74	Swap Key Command	H
	75	Copy Key Command	H
	76	Delete Key Command	H
	77	Set Default Key Command	H
	78	Reset KBD and MDT Command	H
	79	Keyboard Lock Command	H
	80	Keyboard Unlock Command	H
	81	Load Alternate Character Command	H
Machine Control	82	Select Character Set G0/G1 Commands/Responses	HK*
	83	Reset to Initial State Command	H
	84	Cancel Command	HK
	85	Enable/Disable Write Null Commands	H
	86	Enable/Disable Columnar Write Commands	H
	87	Trace On/Off Commands	H
Display	88	Write Host Message Command	H
	89	Display Host Message Command	H
	90	Display Machine Status Command	H
	91	Write Send Mark Command	HK
	92	Repeat to Address Command	H

Legend: H equals host, K equals keyboard, B equals block mode only

Note: K* applies only to Select Character Set G1 command.

Chapter 5. Programming considerations

1. Set/Read Control 1 Command/Response

ESC space 9 Pa (Set Control 1 Command) (outbound)
ESC space 7 (Read Control 1 Command) (outbound)
ESC space 7 Pa (Read Control 1 Response) (inbound)

Parameter:

Pa Bit 7: Always 1
6: Always 0
5: (Reserved)
4: Machine mode ——— 0 0 IBM 3164 mode(*)
3: " 0 1 IBM 3101 mode
1 0 (Reserved)
1 1 (Reserved)
2: Operating mode ——— 0 0 Echo mode
1: " 0 1 Character mode
1 0 Block mode(*)
1 1 (Reserved)

Notes:

1. An asterisk (*) indicates the default setting.
2. Since it takes approximately 500 milliseconds for the host to process this command, it is recommended that the host wait about 500 milliseconds before it can issue the next command.

2. Set/Read Control 2 Command/Response

ESC ! 9 Pa1 Pa2 (Set Control 2 Command) (outbound)
ESC ! 7 (Read Control 2 Command) (outbound)
ESC ! 7 Pa1 Pa2 (Read Control 2 Response) (inbound)

Parameter:

Pa1 Bit 7: Always 0
6: Always 1
5: (Reserved)
4: Enter Key Option: Send (0) or Return (1)*
3: Enable Program Color: Default Color (0)* or Program Color (1)
2: CRT Saver ——— 0 0 No saver (*)
1: " 0 1 5 minutes
1 0 10 minutes
1 1 15 minutes

Pa2 Bit 7: Always 1
6: Always 0
5: (Reserved)
4: Disable Set Field Attribute (1)
3: Disable Operator Initiated Transparent Mode (1)
2: New Line Key: CR.LF (0) or CR (1) *
1: Enable LRC Character (1)

Note: An asterisk (*) indicates the default setting.

3. Set/Read Control 3 Command/Response

ESC " 9 Pa1 Pa2 (Set Control 3 Command) (outbound)
 ESC " 7 (Read Control 3 Command) (outbound)
 ESC " 7 Pa1 Pa2 (Read Control 3 Response) (inbound)

Parameter:

Pa1 Bit 7: Always 0
 6: Always 1
 5: Scroll ————— 0 0 No Scroll
 4: " 0 1 Jump Scroll (*)
 1 0 Smooth Scroll
 1 1 (Reserved) } Page Only
 (Temporary)
 3: Line Wrap; Off(0) or On(1) *
 2: Auto Line Feed; Off(0) or On(1) *
 1: ASCII LF Code; Line Feed (0)* or New Line (1)

Pa2 Bit 7: Always 1
 6: Always 0
 5: Scroll ————— 0 0 No Scroll
 4: " 0 1 Jump Scroll (*)
 1 0 Smooth Scroll
 1 1 (Reserved) } NVM Only
 (Permanent)
 3: Insert Character Key; Set Mode (0) * or Insert Space (1)
 2: Tab/Back Tab Key Option; Field (0) * or Column (1)
 1: Return Key Option; Field (0) * or New Line (1)

Note: An asterisk (*) indicates the default setting.

4. Set/Read Control 4 Command/Response

ESC # 9 Pa (Set Control 4 Command) (outbound)
 ESC # 7 (Read Control 4 Command) (outbound)
 ESC # 7 Pa (Read Control 4 Response) (inbound)

Parameter:

Pa Bit 7: Always 1
 6: Always 0
 5: (Reserved)
 4: Send Line Option; Off(0) * or On(1)
 3: Send Data Null Suppression; Off(0) or On(1) *
 2: Lock KBD & Keep MDT; Off(0) * or On(1)
 1: Send Data Format; Text.LTA (0) * or AID.LTA (1)

Note: An asterisk (*) indicates the default setting.

5. Set/Read Control 5 Command/Response (for main port)

ESC \$ 9 Pa1 Pa2 Pa3 Pa4 (Set Control 5 Command) (outbound)
 ESC \$ 7 (Read Control 5 Command) (outbound)
 ESC \$ 7 Pa1 Pa2 Pa3 Pa4 (Read Control 5 Response) (inbound)

Parameter:

Pa1 Bit 7: Always 0
 6: Always 1
 5: 1 Stop Bit (0)* or 2 Stop Bits (1)
 4: Line Speed ————— 0 0 0 0 50 bps
 3: " 0 0 0 1 75 bps
 2: " 0 0 1 0 110 bps
 1: " 0 0 1 1 134.5 bps
 0 1 0 0 150 bps
 0 1 0 1 200 bps
 0 1 1 0 300 bps
 0 1 1 1 600 bps
 1 0 0 0 1200 bps

Chapter 5. Programming considerations

1 0 0 1	1800	bps
1 0 1 0	2400	bps
1 0 1 1	3600	bps
1 1 0 0	4800	bps
1 1 0 1	7200	bps
1 1 1 0	9600	bps (*)
1 1 1 1	19200	bps

Pa2 Bit 7: Always 0
 6: Always 1
 5: EIA RS-422A (0) or RS-232C (1)*
 4: Word Length; 7-Bit (0)* or 8-Bit (1)
 3: Parity ————— 0 0 0 None
 2: " 0 0 1 Space
 1: " 0 1 0 Mark
 0 1 1 Odd (*)
 1 0 0 Even
 1 0 1 (Reserved)
 1 1 0 (Reserved)
 1 1 1 (Reserved)

Pa3 Bit 7: Always 0
 6: Always 1
 5: Response Delay; No Delay (0) or 100 msec.(1)*
 4: (Reserved)
 3: (Reserved)
 2: Line Control ————— 0 0 CRTS
 1: " 0 1 PRTS (*)
 1 0 IPRTS
 1 1 (Reserved)

Pa4 Bit 7: Always 1
 6: Always 0
 5: Enable Outbound Pacing; Off(0) or On(1)*
 4: Enable Inbound Pacing; Off(0) or On(1)*
 3: Break Signal Length; 170 ms (0) or 500 ms (1)*
 2: LTA ————— 0 0 ETX (*)
 1: " 0 1 CR
 1 0 EOT
 1 1 DC3 (XOFF)

Notes:

1. An asterisk (*) indicates the default setting.
2. When the Set Control 5 command is received from the host system and when it specifies a word length or parity bit change, the DTR signal on the main port goes off for about 350 milliseconds.

6. Set/Read Control 6 Command/Response (for auxiliary port)

ESC % 9 Pa1 Pa2 Pa3 Pa4 (Set Control 6 Command) (outbound)
 ESC % 7 (Read Control 6 Command) (outbound)
 ESC % 7 Pa1 Pa2 Pa3 Pa4 (Read Control 6 Response) (inbound)

Parameter:

Pa1 Bit 7: Always 0
 6: Always 1
 5: 1 Stop Bit (0)* or 2 Stop Bits (1)
 4: Aux Line Speed ————— 0 0 0 0 50 bps
 3: " 0 0 0 1 75 bps
 2: " 0 0 1 0 110 bps
 1: " 0 0 1 1 134.5 bps
 0 1 0 0 150 bps
 0 1 0 1 200 bps
 0 1 1 0 300 bps
 0 1 1 1 600 bps

1 0 0 0	1200	bps
1 0 0 1	1800	bps
1 0 1 0	2400	bps
1 0 1 1	3600	bps
1 1 0 0	4800	bps
1 1 0 1	7200	bps
1 1 1 0	9600	bps (*)
1 1 1 1	19200	bps

Pa2 Bit 7: Always 0
 6: Always 1
 5: (Reserved)
 4: Aux Word Length; 7-Bit (0)* or 8-Bit (1)
 3: Aux Parity ————— 0 0 0 None
 2: " 0 0 1 Space
 1: " 0 1 0 Mark
 0 1 1 Odd (*)
 1 0 0 Even
 1 0 1 (Reserved)
 1 1 0 (Reserved)
 1 1 1 (Reserved)

Pa3 Bit 7: Always 0
 6: Always 1
 5: (Reserved)
 4: (Reserved)
 3: (Reserved)
 2: Enable Aux Outbound Pacing; Off(0) or On(1)*
 1: Enable Aux Inbound Pacing; Off(0) or On(1)*

Pa4 Bit 7: Always 1
 6: Always 0
 5: (Reserved)
 4: (Reserved)
 3: Aux Input Data; Ignore (0)* or Passthrough (1)
 2: Aux Trace ————— 0 0 (Reserved)
 1: " 0 1 Received Data (RXD)
 1 0 Transmitted Data (TXD)
 1 1 Both RXD and TXD (*)

Notes:

1. An asterisk (*) indicates the default setting.
2. When the Set Control 6 command is received from the host system, the DTR on the main port goes off for about 350 milliseconds.

7. Set/Read Control 7 Command/Response

ESC & 9 Pa1 Pa2 Pa3 (Set Control 7 Command) (outbound)
 ESC & 7 (Read Control 7 Command) (outbound)
 ESC & 7 Pa1 Pa2 Pa3 (Read Control 7 Response) (inbound)

Parameter:

Pa1 Bit 7: Always 0
 6: Always 1
 5: (Reserved)
 4: Print Key ————— 0 0 Print Page (*)
 3: " 0 1 Print Screen
 1 0 Print Viewport
 1 1 (Reserved)
 2: Time Fill Characters 0 0 0 (*)
 1: " 0 1 1
 1 0 2
 1 1 3

Chapter 5. Programming considerations

Pa2 Bit 7: Always 0
 6: Always 1
 5: Line End Character Selection; CR.LF (0)* or CR (1)
 4: Print Data Null Suppression; Off(0) or On(1)*
 3: Print EOL Option; Off(0) or On(1)*
 2: (Reserved)
 1: "

Pa3 Bit 7: Always 1
 6: Always 0
 5: (Reserved)
 4: Printer Monitor - 0 0 0 0 No Monitor (*)
 3: " 0 0 0 1 Pin 11 Status(+), DTR(+)
 2: " 0 0 1 0 Pin 11 Status(+), DTR(-)
 1: " 0 0 1 1 Pin 11 Status(-), DTR(+)
 0 1 0 0 Pin 11 Status(-), DTR(-)
 0 1 0 1 Pin 11 Status(N/A), DTR(+)
 0 1 1 0 Pin 11 Status(N/A), DTR(-)
 0 1 1 1 Pin 11 Status(+), DTR(N/A)
 1 0 0 0 Pin 11 Status(-), DTR(N/A)
 1 0 0 1 (Reserved)
 : :
 1 1 1 1 (Reserved)

Note: An asterisk (*) indicates the default setting.

8. Create Viewport Command

ESC space r Vt Vid Vdh Vdl Vwh Vwl
 Vid Vdh Vdl Vwh Vwl
 Vid Vdh Vdl Vwh Vwl (outbound)

Parameter: Vt: Viewport Type (1 thru 8)
 Vid: Viewport ID (1 thru 3)
 Vdh,Vdl: Viewport Depth (Dv)
 Vwh,Vwl: Viewport Width (Wv)
 (Refer to the "Two Byte Parameter Value Table" on page 5-82.)

This command is used to create/define the viewports that are required for the user's application program. When the viewports are re-defined, all data in the character buffer is cleared to nulls. All required viewports in relation to the viewport type must be defined at the same time. When less than three viewports are defined by this command, unnecessary parameter sequence <Vid.Vdh.....Vwl> should be eliminated from the parameter list. After creation of the viewports, each viewport has one page with the same dimension of the viewport. If the page size is not suitable for the user's application, the host program must send the Create Partition/Page command.

9. Create Partition/Page Command

ESC q Pid Pdh Pdl Pwh Pwl Pg
 Pid Pdh Pdl Pwh Pwl Pg
 Pid Pdh Pdl Pwh Pwl Pg (outbound)

Parameter: Pid: Partition ID (1 thru 3)
 Pdh,Pdl: Page Depth (1 thru 255)
 Pwh, Pwl: Page Width (1 thru 255)
 Pg: Number of Pages in the Partition (1 thru 4)
 (Refer to the "Two Byte Parameter Value Table" on page 5-82.)

This command is used to create the pages and partitions associated with the viewports that are required for the user's application program. When the pages and partitions are redefined, all data in the character buffer are cleared to nulls. The depth and width of the partition must be equal to or greater than the depth and width of its viewport respectively. When less than three partitions are defined by this command, unnecessary parameter sequence <Pid.Pdh.Pdl.Pwh.Pwl.Pg> should be eliminated from the parameter list.

10. Select Host Partition Command/Response

ESC space q Pid (outbound or inbound)

Parameter: Pid: Partition ID (1 thru 3)

This command is used to specify the partition in which the outbound data is to be received. This command is required whenever the active outbound partition is changed. The Select Host Partition response is transmitted to the host in order to report the partition from which the inbound data is being sent. This response is required whenever the active inbound partition is changed.

When the viewport type 1 is selected, this response is not used. If the inbound response is generated from the PID 1/GID 1 after the partition/page has been created, no select active partition response is generated as the first data.

11. Select Host Page Command/Response

ESC p Gid (outbound or inbound)

Parameter: Gid: Page ID (1 thru 4)

This command is used to specify the page in which the outbound data is to be received. This command is required whenever the active outbound page is changed.

This response is transmitted to the host in order to report the page from which the inbound data is being sent. This response is required whenever the active inbound page is changed.

When the viewport type 1 is selected, this response is not used. If the inbound response is generated from the PID 1/GID 1 after the partition/page has been created, no select active partition response is generated as the first data.

12. Select Active Partition Command/Response

ESC ! q Pid (outbound or inbound)

Parameter: Pid: Partition ID (1 thru 3)

This command is used to change the active partition to the selected partition and to move the cursor to the CCA in the newly activated partition.

This response is sent to the host program at the beginning of the first inbound operation after the partition is changed in block mode.

When the viewport type 1 is selected, this response is not used. If the inbound response is generated from the PID 1/GID 1 after the partition/page has been created, no select active partition response is generated as the first data.

13. Select Active Page Command/Response

ESC space p Gid (outbound or inbound)

Parameter: Gid: Page ID (1 thru 4)

This command is used to determine which page is to be displayed on the screen.

This response is sent to the host program at the beginning of the first inbound operation after the page is changed in block mode.

When the viewport type 1 is selected, this response is not used. If the inbound response is generated from the PID 1/GID 1 after the partition/page has been created, no select active partition response is generated as the first data.

Chapter 5. Programming considerations

14. Jump Partition Command/Response

ESC " A (outbound, inbound, or from the keyboard)

This command performs the same function as the Jump key.

This response is sent to the host when the Jump key is pressed in echo or character mode.

15. Jump Page Command/Response

ESC ! A (outbound, inbound, or from the keyboard)

This command executes the same function as the Page key.

This response is generated when the Page key is pressed in echo or character mode.

16. Window Position Command

ESC r Prh Prl Pch Pcl (outbound)

Parameter: Prh,Prl: Window Start Row Number
Pch,Pcl: Window Start Column Number
(Refer to the "Cursor and Buffer Address Table:" on page 5-80.)

This command is used to move the window to a specified position in the page. If the window moves out of the page, the command error condition occurs.

17. Window Up Command/Response

ESC space A (outbound, inbound, or from the keyboard)

This command performs the same function as the Up key.

This response is sent to the host when the Up key is pressed in echo or character mode.

18. Window Down Command/Response

ESC space B (outbound, inbound, or from the keyboard)

This command performs the same function as the Down key.

This response is sent to the host when the Down key is pressed in echo or character mode.

19. Window Right Command/Response

ESC space C (outbound, inbound, or from the keyboard)

This command performs the same function as the Right key.

This response is sent to the host when the Right key is pressed in echo or character mode.

20. Window Left Command/Response

ESC space D (outbound, inbound, or from the keyboard)

This command performs the same function as the Left key.

This response is sent to the host when the Left key is pressed in echo or character mode.

21. Set Field Attribute Command/Response

ESC 3 Pa1 Pa2 Pa3 (outbound, inbound, or from the keyboard-Default Color Mode)

ESC 3 Pa1 Pa2 Pa3 Pa4 (outbound, inbound, or from the keyboard-Program Color Mode)

Parameter:

Pa1 Bit 7: Always 0

6: Always 1

5: Non-display (default is 0)

4: High Intensity (ignored in Program Color mode) (default is 0)

3: Blink (default is 0)

2: Underline (default is 0)

1: Reverse (default is 0)

Pa2 Bit 7: Always 0

6: Always 1

5: Auto Send (default is 0)

4: Numeric (default is 0)

3: Must Enter (default is 0)

2: Protected (default is 0)

1: Modified Data Tag (MDT) (default is 0)

Pa3 Bit 7: 1 (Default Color mode) or 0 (Program Color mode)

6: 0 (Default Color mode) or 1 (Program Color mode)

5:  0 0 No Fill (default)

4:  0 1 Right Justify w/Zero

1 0 Right Justify w/Space

1 1 Must Fill

3: Foreground Color for Program Color mode 0 0 0 Black

2: " 0 0 1 Blue

1: " 0 1 0 Green (default)

0 1 1 Turquoise (Light Blue)

1 0 0 Red

1 0 1 Magenta (Purple)

1 1 0 Yellow

1 1 1 White

Pa4 Bit 7: Always 1

6: Always 0

5: (Reserved)

4: (Reserved)

3: Background Color for Program Color mode 0 0 0 Black (default)

2: " 0 0 1 Blue

1: " 0 1 0 Green

0 1 1 Turquoise (Light Blue)

1 0 0 Red

1 0 1 Magenta (Purple)

1 1 0 Yellow

1 1 1 White

Note: When Program Color is disabled by the Set Control 2 command, this command will be rejected each time it is entered from the keyboard and INVALID KEY will be displayed in the operator information area after the final character has been keyed-in.

This command is used to write a field attribute in the character buffer. Parameters can be truncated in the middle of a parameter sequence by specifying a final parameter value. The high intensity bit is meaningful only in the default color mode and not in the program color mode.

Chapter 5. Programming considerations

This response is used in the inbound data stream in response to the Read All command.

22. Set Character Attribute Command/Response

ESC 4 Pa1 (outbound, inbound, or from the keyboard-Default Color mode)

ESC 4 Pa1 Pa2 Pa3 (outbound, inbound, or from the keyboard-Program Color mode)

Parameter:

- Pa1 Bit 7: 1 (Default Color mode) or 0 (Program Color mode)
6: 0 (Default Color mode) or 1 (Program Color mode)
5: Non-display (default is 0)
4: High Intensity (ignored in Program Color mode) (default is 0)
3: Blink (default is 0)
2: Underline (default is 0)
1: Reverse (default is 0)
- Pa2 Bit 7: Always 0
6: Always 1
5: (Reserved)
4: (Reserved)
3: Foreground Color for Program Color mode 0 0 0 Black
2: " 0 0 1 Blue
1: " 0 1 0 Green (default)
0 1 1 Turquoise (Light Blue)
1 0 0 Red
1 0 1 Magenta (Purple)
1 1 0 Yellow
1 1 1 White
- Pa3 Bit 7: Always 1
6: Always 0
5: (Reserved)
4: (Reserved)
3: Background Color for Program Color mode 0 0 0 Black (default)
2: " 0 0 1 Blue
1: " 0 1 0 Green
0 1 1 Turquoise (Light Blue)
1 0 0 Red
1 0 1 Magenta (Purple)
1 1 0 Yellow
1 1 1 White

This command is used to specify the character attribute. Once the character attribute is specified, it is effective until a new character attribute or a new field attribute appears in the data stream. Parameters can be truncated in the middle of a parameter sequence by specifying a final parameter value. The high intensity bit is meaningful only in the default color mode and not in the program color mode.

This response is used in the inbound data stream in response to the Read All command. It is also sent to the host when the host issues the Enable CA Transmission command. The high intensity bit is meaningful only in the default color mode and not in the program color mode.

23. Enable CA Transmission Command

ESC \$: (outbound)

When this command is received, the display station sends the data stream including the Set Character Attribute response in the inbound operation.

24. Disable CA Transmission Command

ESC \$; (outbound)

When this command is received, the display station does not send the Set Character Attribute response in the inbound data stream except the Read All command.

Note: After the display station is powered on, the CA transmission is disabled.

25. Reset Character Attribute Command

ESC \$ 4 (outbound or from the keyboard)

When this command is received, the latest rendition specified from the keyboard becomes ineffective.

26. Set Single-Height Single-Width (SHSW) Command

ESC space 4 (outbound)

This command is used to change the line attribute of the current active line to the single-height single-width attribute.

27. Set Single-Height Double-Width (SHDW) Command/Response

ESC ! 4 (outbound or inbound)

This command is used to change the line attribute of the current active line to the single-height double-width attribute. If the current active line is a single-width line, half of the character string disappears at the right-hand side of the line and is destroyed.

28. Set Double-Height Single-Width (DHSW) Command/Response

ESC " 4 (outbound or inbound)

This command is used to change the line attribute of the current active line to the double-height single-width attribute. If the current active line is a single-height single-width line, all characters on the next lower line are destroyed.

29. Set Double-Height Double-Width (DHDW) Command/Response

ESC # 4 (outbound or inbound)

This command is used to change the line attribute of the current active line to a double-height double-width attribute. If the current active line is a single-width line, all characters on the next lower line and half of the character string at the right-hand side of the line is destroyed.

30. Print Viewport Command

ESC W (outbound)

When this command is received, data in the viewport of the active outbound page is transferred to the auxiliary port. The buffer address (BA) and the cursor address (CA) do not move.

Chapter 5. Programming considerations

31. Print Screen Command

ESC space W (outbound)

When this command is received, data in the whole screen is transferred to the auxiliary port.

32. Print Page Command

ESC ! W (outbound)

When this command is received, data in the active outbound page is transferred to the auxiliary port. The buffer address (BA) and the cursor address (CA) do not move.

33. Print Message Command

ESC V (outbound)

When this command is received, data is transferred to the auxiliary port in the same way as the Pr Msg key. The buffer address (BA) and the cursor address (CA) do not move. The send mark does not move.

34. Print Line Command

ESC U (outbound)

When this command is received, data is transferred to the auxiliary port in the same way as the Print Line key. The buffer address (BA) and the cursor address (CA) do not move.

35. Erase EOL/F Command/Response

ESC I (outbound, inbound, or from the keyboard)

When this command is received, the same function as the Erase EOF key is performed. In echo or character mode, this response is generated by the Erase EOF key.

36. Erase Input Command/Response

ESC K (outbound, inbound, or from the keyboard)

When this command is received, the same functions as the Er Inp key is performed. In echo or character mode, this response is generated by the Er Inp key.

37. Erase EOP Command/Response

ESC J (outbound, inbound, or from the keyboard)

When this command is received, the same function as the Erase EOP key is performed. In echo or character mode, this response is initiated by the Erase EOP key.

38. Clear Page Command/Response

ESC L (outbound, inbound, or from the keyboard)

When this command is received, the current outbound page (including all attributes) is cleared to nulls, and either the cursor or buffer addresses (CA or BA) is set to the first character position of the page. Column tab stops are also cleared.

This response is initiated by the Clear key.

39. Clear Partition Command

ESC space L (outbound or from the keyboard)

When this command is received, all pages (including all attributes) in the active outbound partition are cleared to nulls, and either the cursor or buffer addresses (CA or BA) in all pages is set to the first character position of each page. Column tab stops are also cleared.

40. Clear All Command

ESC ! L (outbound or from the keyboard)

When this command is received, all partitions (including all attributes) in the character buffer are cleared to nulls, and either the cursor or buffer addresses (CA or BA) in all pages is set to the first character position of each page. Column tab stops are also cleared.

41. Insert Line Command/Response

ESC N (outbound, inbound, or from the keyboard)

When this command is received, the same function as the Ins Ln key is performed.

This response is sent to the host when the Insert key is pressed in echo or character mode.

42. Delete Line Command/Response

ESC O (outbound, inbound, or from the keyboard)

When this command is received, the same function as the Del Ln key is performed.

This response is sent to the host when the Del Ln key is pressed in echo or character mode.

43. Insert Character Command/Response

ESC P Pa (outbound, inbound, or from the keyboard)

Parameter: Pa Graphic character to be inserted

When this command is received, the specified graphic character is inserted at the current buffer address (in BA mode) or cursor address (in CA mode).

This response is sent to the host when the Insert key is pressed in echo or character mode. Refer to the section on the Insert key for details.

44. Delete Character Command/Response

ESC Q (outbound, inbound, or from the keyboard)

When this command is received, the character which is located at the current cursor address (in CA mode) or buffer address (in BA mode) is deleted in the same way as the Delete key.

This response is sent to the host when the Delete key is pressed in echo or character mode.

Chapter 5. Programming considerations

45. Set Column Tab Command

ESC 0 (outbound or from the keyboard)

This command causes the display station to set a column tab at the current cursor address (in CA mode) or the current buffer address (in BA mode).

46. Clear Column Tab Command

ESC 1 (outbound or from the keyboard)

This command causes the display station to delete any tab stops from the column in which the cursor/buffer address is located.

47. Clear All Tabs Command

ESC space 1 (outbound or from the keyboard)

This command causes the display station to delete all tab stops in the active page.

48. Back Tab Command/Response

ESC 2 (outbound, inbound, or from the keyboard)

This command performs the same function as the Back Tab key.

This response is sent to the host in echo or character mode, when the Back Tab key is pressed.

49. Set Buffer Address (SBA) Command/Response

ESC X Pr Pc (outbound or inbound)

Parameter: The parameters are listed on the "Cursor and Buffer Address Table" on page 5-80.

This command is used to move the current buffer address to any position in the page.

This response is used to report the starting position of the modified field data in the inbound data stream.

50. Extended Set Buffer Address (XSBA) Command/Response

ESC x Prh Prl Pch Pcl (outbound or inbound)

Parameter: The parameters are listed on the "Cursor and Buffer Address Table" on page 5-80.

If the parameter range exceeds 95, the XSBA command/response is used instead of the SBA command/response.

51. Reset Buffer Address Mode Command

ESC space Z (outbound)

When this command is received, the display station exits from the buffer address (BA) mode and then enters into the cursor address (CA) mode by the use of the latest cursor address.

52. Set Cursor Address (SCA) Command/Response

ESC Y Pr Pc (outbound or inbound)

Parameter: The parameters are listed on the "Cursor and Buffer Address Table" on page 5-80.

This command is used to move the current cursor address to any position in the page.

This response is used to report the cursor position when the Read Cursor command is received.

53. Extended Set Cursor Address (XSCA) Command/Response

ESC y Prh Prl Pch Pcl (outbound or inbound)

Parameter: The parameters are listed on the "Cursor and Buffer Address Table" on page 5-80.

If the parameter range exceeds 95, the XSCA command/response is used instead of the SCA command/response.

54. Cursor Up/Down/Right/Left Commands/Responses

ESC A (Cursor Up Command) (outbound, inbound, or from the keyboard)
ESC B (Cursor Down Command) (outbound, inbound, or from the keyboard)
ESC C (Cursor Right Command) (outbound, inbound, or from the keyboard)
ESC D (Cursor Left Command) (outbound, inbound, or from the keyboard)

The Cursor Up and Down commands are used to move the current cursor address (CCA) up and down one line respectively.

The Cursor Right and Left commands are used to move the CCA one column to the right and left respectively. In echo or character mode, the Cursor Up, Cursor Down, Cursor Right, and Cursor Left responses are sent to the host when the corresponding cursor move keys are pressed.

55. Cursor Home Command/Response

ESC H (outbound, inbound, or from the keyboard)

This command is used to move the CCA to the specified home position. The home position is the first character position of the top line in the page. In echo or character mode, the Cursor Home response is sent to the host when the Home key is pressed.

56. Next Line Command

ESC M (outbound or from the keyboard)

In the unformatted page, this command moves the CA/BA to the first character position of the next line. If the CA/BA is located at the bottom of the page, the new CA/BA moves to the first character position of the top line. If the Scroll option is enabled, the scroll-up is performed and the CA/BA is repositioned to the first character position of the newly created line.

In the formatted page, this command causes the CA/BA to move to the first unprotected character position of the lower line. This operation wraps from the bottom line of the page to the top line of the page.

Chapter 5. Programming considerations

57. Index Command

ESC space M (outbound or from the keyboard)

When this command is received, the line feed function is performed; the cursor address (in CA mode) or buffer address (in BA mode) moves down one line without changing the column. Auto-windowing or scroll-up is executed, if required.

58. Reverse Index Command

ESC ! M (outbound or from the keyboard)

When this command is received, the cursor address (in CA mode) or buffer address (in BA mode) moves up one line without changing the column. Auto-windowing or scroll-down is executed, if required.

59. Insert Cursor Command

ESC Z (outbound)

This command is used to set the current cursor address to the current buffer address. Execution of this command does not change the current buffer address.

60. Read Status Command/Response

ESC 6		(Read Status Command) (outbound)
ESC 6 Pa1 Pa2		(Read Status Response) (inbound)
Parameter:	Pa1	Bit 7: Always 0
		6: Always 1
		5: Communication Buffer Overrun
		4: Line Parity Error Detected
		3: (Reserved)
		2: Command Error
		1: "
		0 0 No Error
		0 1 Undefined Command
		1 0 Invalid Parameter
		1 1 Inapplicable Command
	Pa2	Bit 7: Always 1
		6: Always 0
		5: Printing
		4: Printer Status (Pin 11)
		3: Printer Status (Pin 20: DTR)
		2: (Reserved)
		1: Local mode

When this command is received, the display station sends the machine status described in the parameter.

61. Read Model Command/Response

ESC space 6		(Read Model Command) (outbound)
ESC space 6 Pa		(Read Model Response) (inbound)
Parameter:	Pa	Bit 7: Always 1
		6: Always 0
		5: (Reserved)
		4: (Reserved)
		3: Model 11 (0) Model 12 (1)
		2: Machine Type
		1: "
		0 0 (Reserved)
		0 1 IBM 3161
		1 0 IBM 3163
		1 1 IBM 3164

The host program can use this command to check which model of the display station is attached to the communication network.

62. Read Terminal ID Command and Response

ESC ! 6 (Read Terminal ID Command) (outbound)
ESC ! 6 Pa ESC 6 (Read Terminal ID Response) (inbound)

Parameter: Pa: Terminal ID (A maximum of 20 characters may be input.)

The host program can use this command to check the terminal ID.

63. Read Cursor Address Command

ESC 5 (outbound)

When this command is received from the host, the display station transmits the SCA or XSCA response to the host.

64. Enable Unprotected Field Data Transmission Command

ESC % : (outbound)

After this command is received from the host, unprotected field data is transmitted to the host in response to the following command or key input, if the page is formatted.

- Read Page, Read Message, Read Line, Read Field commands
- Send, Send Msg, Send Line keys.

65. Disable Unprotected Field Data Transmission Command

ESC % : (outbound)

After this command is received from the host, only the modified field data is transmitted to the host in response to the following command or key input.

- Read Page, Read Message, Read Line, Read Field commands
- Send, Send Msg, Send Line keys.

66. Read Page Command

ESC 8 (outbound)

When this command is received from the host, the display station sends the contents of the active outbound page to the host. If the page is formatted, the volume and the type of field data to be sent to the host (modified data only or unprotected data only) will depend on the setting of the field data transmission mode from the host. When the Send key is pressed, the Send AID code is sent to the host at the beginning of the data stream, if specified.

Chapter 5. Programming considerations

67. Read Message Command

ESC space 8 (outbound)

When this command is received from the host, the display station sends the message data in the same way as the Sn Msg key. If the page is formatted, the volume and the type of field data to be sent to the host (modified data only or unprotected data only) will depend on the setting of the field data transmission mode from the host. When the Sn Msg key is pressed, the Send Message AID code is sent to the host at the beginning of the data stream, if specified.

68. Read Line Command

ESC ! 8 (outbound)

When this command is received from the host, the display station sends the line data in the same way as the Send Line key. If the page is formatted, the volume and the type of field data to be sent to the host (modified data only or unprotected data only) will depend on the setting of the field data transmission mode from the host. When the Send Line key is pressed, the Send Line AID code is sent to the host at the beginning of the data stream, if specified.

69. Read Field Command

ESC " 8 (outbound)

When this command is received from the host, the display station sends the data of the field that is identified by the cursor address (in CA mode) or the buffer address (in BA mode). If the page is formatted, the volume and the type of field data to be sent to the host (modified data only or unprotected data only) will depend on the setting of the field data transmission mode from the host. If the page is unformatted, the Read Line operation is performed.

70. Read All Command

ESC # 8 (outbound)

This command is used to read all data in the current active outbound page. Even if the page is formatted, the display station transfers all data regardless of MDT bits.

71. Load Programmable Function Key Command

ESC ! = Fn Ff Fp ESC = (outbound)

Parameter:

- Fn: Function Key Number
- Bit 7: Always 0
- 6: Always 1
- 5-1: Function Key Number (1 through 24)

- Ff: Command Flag
- Bit 7: Always 0
- 6: Always 1
- 5-2: Always 0
- 1: 0: AID format
1: Data Stream format

- Fp: Data (A maximum of 64 characters)

This command is used to redefine the function of the Function key. If the original AID format is specified, pressing the Function key causes the display station to transmit its sequence to the host. If the data stream is specified, the data stored in the non-volatile memory (NVM) is handled as the keyboard data or the host data.

Notes:

1. A maximum of 64 characters can be stored in each Function key.
2. The Function key data must not exceed 256 characters.

72. Set Default Function Key Command

ESC t Fn (outbound)

Parameter: Fn: Function Key Number
Bit 7: Always 1
6: Always 0
5 - 1: Function Key Number (1 through 24)

This command is used to return a Function key to the original AID function.

73. Set All Default Function Keys Command

ESC space t (outbound)

This command is used to return all Function keys to the original AID setting.

74. Swap Key Command

ESC s P1h P1l P2h P2l (outbound)

Parameter: P1h Bit 7: Always 0
6: Always 1
5: See Note
4: }
3: } High order digit of key ID
2: }
1: }

P1l Bit 7: Always 0
6: Always 1
5: See Note
4: }
3: } Low order digit of key ID
2: }
1: }

P2h Bit 7: Always 0
6: Always 1
5: See Note
4: }
3: } High order digit of key ID
2: }
1: }

P2l Bit 7: Always 1
6: Always 0
5: See Note
4: }
3: } Low order digit of key ID
2: }
1: }

Note: Shift Status

Shift	Bit 5 of P1h/P2h	Bit 5 of P1l/P2l
Up	0	0

Chapter 5. Programming considerations

Down	0	1
Control	1	0
(Reserved)	1	1

This command is used to swap two function keys.

75. Copy Key Command

ESC space s P1h P1l P2h P2l (outbound)

Parameter: P1h.P1l: Source key ID
P2h.P2l: Destination key ID
The use of these parameters is the same as the Swap Key command.

This command is used to copy a function from one key to another.

76. Delete Key Command

ESC ! s Ph Pl (outbound)

Parameter: Ph Pl: Key ID to be deleted.

This command is used to delete a function from the keyboard.

77. Set Default Key Command

ESC " s (outbound)

When this command is received from the host, the display station changes the rearranged keyboard layout to the default setting of the display station.

78. Reset KBD and MDT Command

ESC ! S (outbound)

This command is used to unlock the keyboard and reset the MDT bit to 0 after the send/read operation, if the Lock KBD & Keep MDT option is on.

79. Keyboard Lock Command

ESC : (outbound)

This command can be used to disable the keyboard as a data entry device,

- until the Keyboard Unlock command is received from the host, or
- until the Cancel key is pressed.

Only the Setup, Select, Ctrl, Shift, Caps Lock, and Cancel keys are functional when the keyboard is locked. When locked, KEYS LOCKED appears in the operator information area.

80. Keyboard Unlock Command

ESC ; (outbound)

This command is used to unlock the keyboard after it is locked by the Keyboard Lock command. The key locked condition is cleared and the indicator KEYS LOCKED disappears from the screen. If the keyboard is already unlocked, there is no effect.

81. Load Alternate Character Command

ESC space = Lch Lcl $\underbrace{(Rp)Dp}_{\text{cell(s)}}$ $\underbrace{(Rp)Dp}_{\text{cell(s)}}$ ---- **ESC** = (outbound)

Parameter: Lch: 2X
Lcl: 2Y } where XY is a line code

Rp: 4X or 5X is the number of cells to be repeated
40 is repeat once (default)
41 is repeat twice
42 is repeat three times

5F is repeat 32 times

Dp: 6X where X is a 4-dot cell

Refer to the section of alternate characters later on in this chapter.

82. Select Character Set G0/G1 Commands/Responses

ESC < Pa (Select Character Set G0) (outbound or inbound)

ESC > Pa (Select Character Set G1) (outbound, inbound or from the keyboard)

Parameter: Pa @: US ASCII Characters
A: Special Graphics
C: Alternate Character

These commands are used to set the character set to the G0 or G1 space. The G1 space can be accessed with SI, and the G1 space with SO.

These responses are used in the inbound data stream, whenever the character set change is required.

83. Reset to Initial State (RIS) Command

ESC space S (outbound)

When the display station receives this command, it performs the Power-On-Reset (POR) sequence. It cannot receive the data from the host until the POR sequence is completed. It takes about 500 milliseconds.

Chapter 5. Programming considerations

84. Cancel Command

ESC S (outbound or from the keyboard)

When this command is received, the display station performs the same function as the Cancel key.

85. Enable/Disable Write Null Commands

ESC " : (Enable Write Null Command) (outbound)
ESC " ; (Disable Write Null Command) (outbound)

When the Enable Write Null command is received, the null characters in the outbound data stream from the host are stored in the character buffer as null codes, in the same way as graphic characters.

The Disable Write Null command causes the display station to ignore null characters from the host.

After POR, null characters from the host are ignored.

86. Enable/Disable Columnar Write Commands

ESC ! : (Enable Columnar Write Command) (outbound)
ESC ! ; (Disable Columnar Write Command) (outbound)

In the normal operations, the graphic character string is written horizontally in sequence. When the Enable Columnar Write command is received, the CA/BA advances one row as a character is stored. When CA/BA reaches the bottom in the page, the CA/BA wraps to the top without changing its column.

If the Disable Columnar Write command is received, the display station advances the CA/BA as a character is entered in the buffer.

87. Trace On/Off Commands

ESC space : (Trace On Command) (outbound)
ESC space ; (Trace Off Command) (outbound)

These commands work in the same way as the Trace key.

88. Write Host Message Command

ESC =.....ESC = (outbound)

Parameter: Host message This command is used to write a message/text from the host to an 80-character buffer of the IBM 3164. You can display the stored host messages/text on the 25th line by using the Msg key or the Display Host Message command.

The host message can include the following characters/commands.

- ASCII graphic characters (including a space character)
- SI and SO Control Characters
- SCS G0/G1 commands
- Erase EOL command
- Set Field Attribute command
- Set Character Attribute command
- Set SHDW command
- Set SHSW command

Other characters and control sequences are not allowed.

When an error is detected in Write Host Message command, the previously defined host message will be destroyed.

89. Display Host Message Command

ESC # ; (outbound)

This command is used to replace the machine status information in the 25th line with the host message. If the host message is already displayed in the 25th line by the use of this command or the Msg key, this command has no effect.

90. Display Machine Status Command

ESC # : (outbound)

This command is used to replace the host message in the 25th line with the machine status information. If the machine status is already displayed in the 25th line by the use of this command or the Msg key, this command has no effect.

91. Write Send Mark Command

ESC E (outbound or from the keyboard)

This command is used to write a send mark at the current cursor address (in CA mode) or the buffer address (in BA mode). If a new send mark is written, the previously stored send mark is replaced with a null character. Only one send mark is allowed in a page at a time.

92. Repeat to Address Command

ESC z Prh Prl Pch Pcl Pa

Parameter: Prh Prl Pch Pcl: Stop Address
Pa: The character to be repeated.

This command is used to repeat a specified alphanumeric (X'20' through X'7E') or null (X'00') character, starting at the current cursor address (in CA mode) or buffer address (in BA mode) until (but not including) the specified stop address. After the operation, the CA/BA moves to the stop address.

If the stop address is lower than or equal to the current CA/BA, the operation stops at the end of the page.

Chapter 5. Programming considerations

Using the Set Control commands

In addition to the Setup and Select menus, the user can use the seven Set Control commands to change the operating conditions of the display station by programming from the host system. Besides being able to change the operating conditions, the user is able to specify functions unique to the IBM 3164. The following chart shows a summary of the functions:

CONTROLS	No.	NAME	Set Control Command	Setup Menu	Select Menu
Machine Mode	1	IBM 3164 Mode	X1	X	
	2	IBM 3101 Mode	X1	X	
Operating Mode	3	Echo Mode	X1	X	
	4	Character Mode	X1	X	
	5	Block Mode	X1	X	
Machine Control	6	Transparent Mode	X2		
	7	New Line	X2		X
	8	Enter Key Option	X2		X
	9	Disable Set Field Attribute	X2		
	10	CRT Saver	X2		X
	11	Enable LRC	X2		
	12	Enable Program Color	X2		
	13	Tab/Back Tab Key Option	X3		X
	14	Return Key Option	X3		X
	15	Insert Character Key Option	X3		X
Display Control	16	Auto Line Feed	X3		X
	17	Line Wrap	X3		X
	18	Scroll Option	X3		X
	19	ASCII LF Control	X3		
Send Control	20	Send Line Option	X4		X
	21	Send Null Suppression	X4		X
	22	Lock KBD and Keep MDT	X4		
	23	Send Data Format	X4		
Main Port Control	24	Interface	X5	X	
	25	Line Control	X5	X	
	26	Line Speed	X5	X	
	27	Parity	X5	X	
	28	Turnaround Character	X5	X	
	29	Stop Bit	X5	X	
	30	Word Length	X5	X	
	31	Response Delay	X5	X	
	32	Break Signal	X5	X	
	33	Pacing for Main Port	X5		
	Auxiliary Port Control	34	Line Speed	X6	X
35		Parity	X6	X	
36		Stop Bit	X6	X	
37		Word Length	X6	X	
38		Pacing for Aux Port	X6		
39		Trace	X6		X
40		Aux Input Data	X6		
Print Control	41	Print Key Option	X7		X
	42	Time Fill Character	X7		
	43	Line End Character	X7		X
	44	Print EOL	X7		X
	45	Print Data Null Suppression	X7		X
	46	Monitor Printer Status	X7		

Notes:

- Controlled independently in each page.
- The above symbols represent the following:
 - X - Supported
 - X1 - Supported by the Set Control 1 command
 - X2 - Supported by the Set Control 2 command
 - X3 - Supported by the Set Control 3 command
 - X4 - Supported by the Set Control 4 command
 - X5 - Supported by the Set Control 5 command
 - X6 - Supported by the Set Control 6 command
 - X7 - Supported by the Set Control 7 command

No	Name	Description
1	IBM 3164	The IBM 3164 operates in its own mode; IBM 3163 compatible (Default Color) mode or Program Color mode.
2	IBM 3101 emulation mode	The IBM 3164 operates in the IBM 3101 emulation mode.
3	Echo	The display station operates in the echo mode. Data entered from the keyboard is transmitted to the host computer only; data must be sent back to the terminal for screen display or other functions, in a conversational manner.
4	Character	The display station operates in the character mode. Data entered from the keyboard is transmitted to the host computer and is also sent back to the display screen.
5	Block	The display station operates in the block mode. When a Send key is pressed or a Read command is received, the specified data area in the character buffer is sent to the host. This allows the operator to edit the screen data and perform any changes desired before transmitting it to the host computer.
6	Transparent Mode	<p>This option is used to disable the transparent mode. The transparent mode provides the programmer with a means of verifying the use of command codes by enabling the terminal to display all code sequences as they are entered along with alphanumeric characters. However, it should be noted that command codes are not executed when the transparent mode is active.</p> <p>This mode is activated when the DLE.STX character sequence is received from the host or entered from the keyboard. It is deactivated by the DLE.ETX sequence by the host or the operator.</p>
7	New Line (CR/CR.LF) Option	<p>This option is used to determine the character(s) generated when the Return key is pressed. When the CR (carriage return) option is selected, the Return key generates CR. When the CR.LF (Carriage Return.Line Feed) option is selected, the Return key generates both CR and LF characters.</p> <p>If the CR.LF option is selected in character or echo mode when CR is a line turnaround character, the Return key generates the CR and LF characters and then line turnaround occurs.</p> <p>In character mode, if CR has been selected as the line turnaround character and the CR/CR.LF option is set to CR.LF, pressing the Return key causes the CR and LF functions to be performed, but only the CR character is sent to the host.</p>
8	Enter Key Option	If this option is on, the Enter key functions as the Return key. If this option is off, the Enter key functions as the Send key.
9	Disable Set Field Attribute	This option is for the host system to disable the operator initiated Set Field Attribute command. When disabled, the operator cannot generate or modify any field attribute on the screen.
10	CRT Saver	This option is used to enable/disable the automatic CRT saver function. After 5, 10, or 15 minutes of inactivity (no host or operator input) the display is automatically disabled and the CRT phosphor is preserved, although the character buffer contents are held intact. When data from the host is received or any key is pressed, all CRT contents are again displayed without loss of data. When enabled, one of the three timers (5, 10, or 15 minutes) can be selected.

Chapter 5. Programming considerations

11	Enable LRC	<p>This option is used to enable the terminal to generate a longitudinal redundancy check (LRC) character at the end of a data transmission. This function is effective in all modes; echo, character, and block.</p> <p>The LRC character is automatically generated and sent to the host just after the turnaround character.</p> <p>In CRTS mode, the display station turns off the RTS signal after sending the LRC character. The LRC register is cleared at the beginning of the data transmission. The LRC character is calculated by taking an "exclusive or" independently on each of the individual levels of the transmitted code excluding the parity bit. The turnaround character is included in the LRC accumulation. The correct value of the parity bit for the LRC character is defined so as to maintain the specified parity.</p> <p>The IBM 3164 sends back the ACK or the NAK character to the host in response to the turnaround and LRC characters. ACK is transmitted for a correct LRC character, and NAK is transmitted for an incorrect one.</p> <p>Even if the display station receives an ACK or a NAK from the host system in response to an LRC character, it does not take any action. For a NAK, the host will send an appropriate Read command in order to request the same data again. For a possible retransmission of the text, the Lock KBD and Keep MDT option must be set to on.</p>										
12	Enable Program Color	<p>In Default Color mode, the IBM 3164 emulates the IBM 3163 and displays the four colors of red, green, blue, and white. Which color is displayed for that field depends on the following field and character attribute combinations:</p> <table border="1" data-bbox="699 1031 1269 1184"> <thead> <tr> <th>Foreground Color</th> <th>Combinations of FA/CA</th> </tr> </thead> <tbody> <tr> <td>Green</td> <td>Unprotected and normal display</td> </tr> <tr> <td>Blue</td> <td>Protected and normal display</td> </tr> <tr> <td>Red</td> <td>Unprotected and high intensity</td> </tr> <tr> <td>White</td> <td>Protected and high intensity</td> </tr> </tbody> </table> <p>The background color will be black and the field attribute position will also be black. The underline cursor will appear in white. The block cursor will appear in the foreground color and a character/symbol on the block cursor will be displayed in black. The divider line will appear in blue and characters/symbols in the operator information area in green. In the case of a reverse attribute, the foreground color will change to the background color and vice versa.</p> <p>When the Program Color option is enabled, the terminal is able to display eight colors instead of the original four. The eight colors are:</p> <ul style="list-style-type: none"> ● Black (background default color) ● Red ● Green (foreground default color) ● Blue ● Yellow ● Magenta (Purple) ● Turquoise (Light Blue) ● White. 	Foreground Color	Combinations of FA/CA	Green	Unprotected and normal display	Blue	Protected and normal display	Red	Unprotected and high intensity	White	Protected and high intensity
Foreground Color	Combinations of FA/CA											
Green	Unprotected and normal display											
Blue	Protected and normal display											
Red	Unprotected and high intensity											
White	Protected and high intensity											

12	Enable Program Color (continued)	<p>The foreground and the background colors can be controlled independently. The high intensity attribute is ignored. The underline appears in the same color as the foreground. The underline cursor appears in white. The block cursor causes the foreground color to be replaced with the background color and vice versa. The field attribute positions are displayed in the background color. The divider line is displayed in blue, and characters/symbols in the operator information area are displayed in green. In the case of the reverse attribute, the foreground color is changed to background color and vice versa.</p> <p>The character color attribute is effective only in Program Color mode.</p> <p>Each character can be individually displayed in any of the above eight colors. The foreground and the background color can be controlled independently.</p> <p>If the page is unformatted in Program Color mode, the black and green color attributes are used as default background and foreground color attributes respectively.</p> <p>The underline symbol appears in the same color as the foreground. The underline cursor appears in white. In the case of the reverse attribute, the foreground color is changed to the background color and vice versa.</p>
13	Tab/Back Tab Key Option	<p>If this option is on, the tab stops can be set at any character position in each viewport regardless of the field attribute character position.</p> <p>If this option is off, the column tab stops are ignored and the tab operation depends on the field attribute character position.</p>
14	Return Key Option	Refer to the description of the Return key.
15	Insert Character Key Option	Refer to the description of the Insert Character key.
16	Auto Line Feed	<p>The Auto Line Feed option, when on, causes the cursor to move to the first character location of the next line when the operator presses the Carriage Return (CR) key or when the CR character is received from the host.</p> <p>When this option is off, the cursor moves to the first character location of the current line. Therefore, if the new line function is desired, the host must send (or the operator must enter) the CR and LF characters.</p>
17	Line Wrap	<p>The Line Wrap option, when on, causes the cursor to move to the first character location of the next line in the page, after it reaches the last character location of the current line in the page. If the Scroll option is also on, when the cursor reaches the last character location of the bottom line in the unformatted page, the page data scrolls up, and the cursor moves to the first character location of the newly created bottom line. If the Scroll option is off, the cursor goes to the top of the page.</p> <p>When the Line Wrap option is off, the cursor does not advance to the first character location of the next line. Instead, it stays at the last character location. In this case, the audible alarm sounds whenever the operator enters data at the last character location. If additional characters are entered, they are transferred to the host, and the displayed character in the last character position changes as each character is entered.</p> <p>The Line Wrap option is automatically set to on in block mode.</p> <p>Two types of scroll operations are available; jump scroll and smooth scroll. Smooth scroll allows the terminal to move the data up/down at an even rate of 4 rows per second.</p>

Chapter 5. Programming considerations

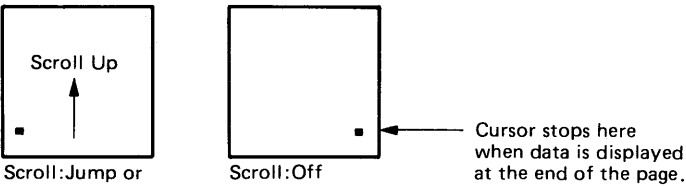
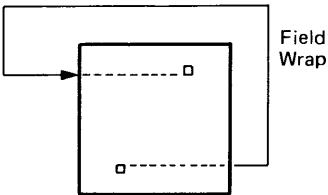
18	Scroll Option	<p>If the Scroll option is on in the unformatted page and the cursor in the bottom line of the page, the page data scrolls up when:</p> <ul style="list-style-type: none"> ● The following character is received from the host program or entered from the keyboard. <ul style="list-style-type: none"> - CR with Auto Line Feed is on - LF, VT, or FF - HT (or Tab Key) at the last tab stop position (Line Wrap option is on). ● The Next Line command or the Index command is received. ● Line Wrap option is on, the cursor is at the last character position of the page, and an additional character is received from the host program or entered from the keyboard. <p>If the Scroll option is enabled in the unformatted page and the cursor in the top line of the page, the page data scrolls down when:</p> <ul style="list-style-type: none"> ● The Reverse Index command is received. ● The Back Tab key is pressed or the Back Tab command is received. <p>When the page data scrolls up or down, the top or bottom line in the page disappears, and a new line is created. The cursor moves to the newly created bottom or top line.</p> <p><i>Notes:</i></p> <ol style="list-style-type: none"> 1. When the page is formatted, the Scroll option is automatically assumed to be off. 2. This option may be set independently for each partition. 3. The ASCII LF option is assumed to be off. <p>In the formatted page, the last field continues from the last character location to the first character location in the page until it is terminated by a field attribute character.</p> <p>If the Scroll option is off in the unformatted page, the page terminates at the last character position of the page.</p> <p>The following figure illustrates the relationship between the Scroll option and the Wrap function.</p> <p>Unformatted page</p>  <p>Formatted page</p>  <p>Legend: ■ Current Cursor Address (CCA) □ Field Attribute (FA)</p>
----	---------------	---

19	ASCII LF Control	<p>This option is used to determine where the CA/BA should be located when the LF code is received from the host or keyboard.</p> <p>If this option is off, the CA/BA moves down one row without changing the column.</p> <p>If this option is on, the new line function is performed instead of the line feed function.</p>																		
20	Send Line Option	<p>If this option is on, the Send key performs the same function as the Send Line key, and the Send Line key works as the Send key.</p>																		
21	Send Null Suppression	<p>When this parameter is on, the trailing nulls are suppressed during the inbound block data transfer. If it is off, a null character is converted to a space character and transferred to the host system.</p> <p>Trailing nulls are null characters between the last significant character in a field and the end-of-line (EOL), end-of-field (EOF), end-of-page (EOP), or the cursor in a line. The following table shows how null suppression is performed. For example, in a Send Page formatted operation, null characters between the last significant character and EOF or EOP, whichever comes first, are suppressed in each field.</p> <table border="1" data-bbox="753 835 1422 1077"> <thead> <tr> <th></th> <th>Unformatted</th> <th>Formatted</th> </tr> </thead> <tbody> <tr> <td>Send/Read Page</td> <td>EOL</td> <td>EOF or EOP *</td> </tr> <tr> <td>Send/Read Message</td> <td>EOL or Cursor *</td> <td>EOF or Cursor *</td> </tr> <tr> <td>Send/Read Line</td> <td>EOL</td> <td>EOL or EOF *</td> </tr> <tr> <td>Read Field</td> <td>EOL</td> <td>EOF</td> </tr> <tr> <td>Read All</td> <td colspan="2">No Null Suppression</td> </tr> </tbody> </table> <p>Cursor: cursor position address end-of-line</p> <p>EOF: end-of-field Stop: stop address EOP: end-of-page EOL: *: whichever comes first</p>		Unformatted	Formatted	Send/Read Page	EOL	EOF or EOP *	Send/Read Message	EOL or Cursor *	EOF or Cursor *	Send/Read Line	EOL	EOL or EOF *	Read Field	EOL	EOF	Read All	No Null Suppression	
	Unformatted	Formatted																		
Send/Read Page	EOL	EOF or EOP *																		
Send/Read Message	EOL or Cursor *	EOF or Cursor *																		
Send/Read Line	EOL	EOL or EOF *																		
Read Field	EOL	EOF																		
Read All	No Null Suppression																			
22	Lock KBD and Keep MDT	<p>When this parameter is off, the keyboard remains unlocked and the MDT bits are reset to 0 just after the send/read operation.</p> <p>If this parameter is on, the send/read operation causes the keyboard to be locked and the MDT bits to remain unchanged. SENDING is displayed in the operator information area. In this case, when the Reset keyboard and MDT command is received, the keyboard is unlocked and MDT bits are reset to 0. When the host detects an error, it can send a Read command to invoke retransmission of the terminal data, instead of the 'Reset Keyboard and MDT' command.</p>																		
23	Send Data Format	<p>This parameter is used to determine the type of data stream when a Read command is received, a Send key is pressed in block mode, or the Auto Send function is performed. One of the following data formats can be selected for the convenience of the user.</p> <ul style="list-style-type: none"> - TEXT.LTA (for Read and Send operations) - AID.LTA (for Send operation) <p>Note:</p> <table data-bbox="873 1682 1268 1759"> <tr> <td>TEXT</td> <td>...</td> <td>Terminal Data</td> </tr> <tr> <td>LTA</td> <td>...</td> <td>Line turnaround character</td> </tr> <tr> <td>AID</td> <td>...</td> <td>Attention ID Code</td> </tr> </table> <p>ESC 8 (Send Page) ESC space 8 (Send Message) ESC ! 8 (Send Line) ESC " 8 (Auto Send Field)</p>	TEXT	...	Terminal Data	LTA	...	Line turnaround character	AID	...	Attention ID Code									
TEXT	...	Terminal Data																		
LTA	...	Line turnaround character																		
AID	...	Attention ID Code																		

Chapter 5. Programming considerations

24	Interface for main port	This parameter is used to specify the communication interface of the main port and applies only to models equipped with the EIA RS-232C and RS-422A interfaces.																
25	Line Control for main port	<p>This parameter depends on the type of telecommunication facility and affects the display station with the EIA RS-232C interface only. One of the following can be selected.</p> <ul style="list-style-type: none"> ● Controlled Request To Send (CRTS) ● Permanent Request To Send (PRTS) ● Induced Permanent Request To Send (IPRTS). <p>If a duplex communication facility is used and the display station is in duplex operation, the RTS signal must stay on; therefore, this parameter must be set to either PRTS or IPRTS. Under the same facility, when the display station is in half-duplex operation, this parameter can be set CRTS, PRTS, or IPRTS, depending on the host support.</p> <p>If the half-duplex communication facility is used, the RTS signal must be controlled; therefore, this parameter must be set to CRTS.</p> <p>In IPRTS mode, the Clear-To-Send (CTS) and the Data-Set-Ready (DSR) signals are always regarded as on.</p>																
26	Line Speed for main port	<p>This parameter is used to select the line speed to communicate with the host. One of the following sixteen (16) speeds is available.</p> <table border="0" data-bbox="690 947 1252 1050"> <tr> <td>50 bps</td> <td>150 bps</td> <td>1200 bps</td> <td>4800 bps</td> </tr> <tr> <td>75</td> <td>200</td> <td>1800</td> <td>7200</td> </tr> <tr> <td>110</td> <td>300</td> <td>2400</td> <td>9600</td> </tr> <tr> <td>134.5</td> <td>600</td> <td>3600</td> <td>19200</td> </tr> </table>	50 bps	150 bps	1200 bps	4800 bps	75	200	1800	7200	110	300	2400	9600	134.5	600	3600	19200
50 bps	150 bps	1200 bps	4800 bps															
75	200	1800	7200															
110	300	2400	9600															
134.5	600	3600	19200															
27	Parity for main port	<p>This parameter is used to select the type of parity. In relation to the data word length (7 or 8-bit selection), the following combinations are valid.</p> <ul style="list-style-type: none"> ● 7-bit with no parity ● 7-bit plus odd parity ● 7-bit plus even parity ● 7-bit plus mark parity ● 7-bit plus space parity ● 8-bit plus odd parity ● 8-bit plus even parity ● 8-bit plus no parity. <p>The following combinations of the word length and parity options are invalid:</p> <ul style="list-style-type: none"> ● 8-bit and mark parity ● 8-bit and space parity. 																
28	Turnaround Character for main port	<p>This option is used to automatically generate one of the following turnaround characters at the end of a data stream when a Send or a Function key is pressed, or a Read command is received:</p> <ul style="list-style-type: none"> ● ETX ● CR ● EOT ● DC3 (XOFF). 																
29	Stop Bit for main port	This parameter is used to select the number of stop bits following a data word: one (1) or two (2).																

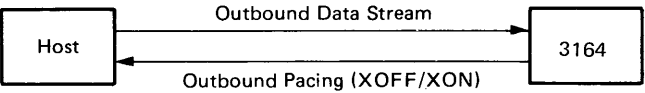
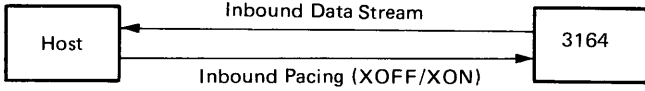
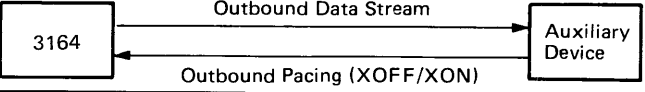
30	Word Length for main port	<p>This parameter is used to select from either of the following data lengths:</p> <ul style="list-style-type: none"> ● 7-bit Character Set ● 8-bit Character Set.
31	Response Delay for main port	<p>This parameter is used to specify the minimum response delay time when a Read command is received. Either no delay or 100 ms can be selected.</p>
32	Break Signal for main port	<p>This parameter is used to determine how long the break (space) signal sent to the host system will be when the Break key is pressed. In PRTS/IPRTS mode, either 170 ms or 500 ms can be selected.</p>
33	Pacing for Main Port	<p>This option allows the terminal or host system to control the data flow. Data flow in both directions is paced.</p> <p>The pacing function is performed only when the following communication interface/line control is specified:</p> <ul style="list-style-type: none"> ● EIA RS-422A ● EIA RS-232C with PRTS ● EIA RS-232C with IPRTS. <p>If pacing is specified for the outbound data stream, the display station sends the XOFF signal to the host in order to prevent a buffer overrun. When the host system receives the XOFF signal, it must stop the outbound data flow immediately, otherwise that data will be lost. When the host system receives the XON signal, it resumes the outbound data transmission.</p>  <p>If pacing is specified for the inbound data stream, the host system sends the XOFF signal to the display station in order to stop the inbound data transmission. When the display station receives the XOFF signal, it stops the inbound transmission immediately, and waits for XON. When the display station receives XON, it resumes the inbound data transmission.</p>  <p>Pacing is not possible if the DC3 character is used as the line turnaround character.</p>
34	Line Speed for auxiliary port	<p>The description for the main port applies. Refer to No. 26.</p>
35	Parity for auxiliary port	<p>The description for the main port applies. Refer to No. 27.</p>
36	Stop Bit for auxiliary port	<p>The description for the main port applies. Refer to No. 29.</p>
37	Word Length for auxiliary port	<p>The description for the main port applies. Refer to No. 30.</p>
38	Pacing for auxiliary port	<p>If pacing is specified for the outbound data stream, the auxiliary device sends the XOFF signal to the IBM 3164 to stop the outbound data transmission. When the IBM 3164 receives this XOFF signal, it displays AUX BUSY, and stops the data transmission to the auxiliary device immediately. The IBM 3164 does not inform the host of the XOFF state. It waits for the next XON signal from the auxiliary device, and after it receives this signal, resumes the outbound data transmission.</p> 

Chapter 5. Programming considerations

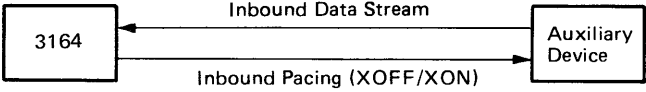
38	Pacing for auxiliary port (continued)	<p>If pacing is specified for the inbound data stream, the display station sends the XOFF signal to the auxiliary device to avoid a buffer overrun. When the auxiliary device receives XOFF, it must stop the inbound data transmission immediately. After the auxiliary device receives XON, it resumes the inbound data transmission.</p>  <p>Pacing is not possible if the DC3 character is used for a line turnaround character.</p>
39	Trace	<p>This parameter is used to select the type of data traced when the Trace key is pressed.</p> <p>In trace mode, the inbound/outbound data of the main port can be transferred to the auxiliary port without disturbing communications with the host system. One of the following can be specified.</p> <ul style="list-style-type: none"> ● inbound data ● outbound data ● both inbound and outbound data. <p>If pacing is specified for both the inbound and outbound data streams in PRTS mode, only the outbound data is transferred to the auxiliary port.</p>
40	Auxiliary Input Data	<p>This parameter is used to determine the handling of the input data stream from an auxiliary device.</p> <ul style="list-style-type: none"> ● If the Ignore parameter is specified, the display station unconditionally discards the input data from the auxiliary device. ● If the Passthrough parameter is specified, the input data stream is divided into several blocks before being sent to the host. The DLE.DC2 sequence is appended at the beginning of the data block, and DLE.DC4 at the end.
41	Print Key Option	<p>This option is used to select one of the following functions of the Print key.</p> <ul style="list-style-type: none"> ● Print Page ● Print Screen ● Print Viewport.
42	Time Fill Character	<p>This parameter is used to determine the number of time-fill characters (DELS) to be sent to the printer at the end of each print line.</p>
43	Line End Character	<p>This parameter is used to select the line end character (CR.LF or CR) that is sent to the printer whenever the one print line is terminated before reaching the right edge of the viewport (for Print Viewport), the screen (for Print Screen), or the page (for Print Page/Message/Line). If the printed data length reaches the rightmost column of the viewport (for Print Viewport), the screen (for Print Screen), or the page (for Print Page/Message/Line), the Line End character (No LE, CR.LF, or CR) is determined by the Print EOL Option.</p>

44 Print EOL

This option is used to determine whether to generate the Line End Character at the end of the printed line or not, when the printed data length is equal to the viewport width (for Print Viewport), the screen width (for Print Screen), or the page width (for Print Page/Message/Line). If this option is off, no line end character will be inserted even though the above conditions are met. If this option is on, the line end character (CR.LF or CR) specified by the Line End Character Selection is sent to the printer.

45 Print Data Null Suppression

When this parameter is on, the trailing nulls are suppressed during a buffer printout. Trailing nulls are null characters between the last significant character and the end-of-line (the cursor for Print Message). The following table shows the relationship between the Null Suppression, Print EOL, and Line End Character Selection options:

		Print Data Null Suppression	
		Off	ON
			LL = WD
Print EOL Option	ON	Line End Character (CR.LF or CR)	Line End Character (CR.LF or CR)
	OFF	No Line End Character	

Legend: LL : The actual print data length
 WD : Page width (for Print Page), Screen width (for Print Screen), or Viewport width (for Print Viewport)

46 Monitor Printer Status

In order to monitor the status of the printer or the IBM 3164 attached to the auxiliary port, two EIA level signals are available. They are; the Printer Status (pin 11 of the printer) and DTR (pin 20 of the printer) signals.

These two signals can be monitored on pins 11 and 20 of the auxiliary port.

The following figure shows a typical connection to monitor these two signals.

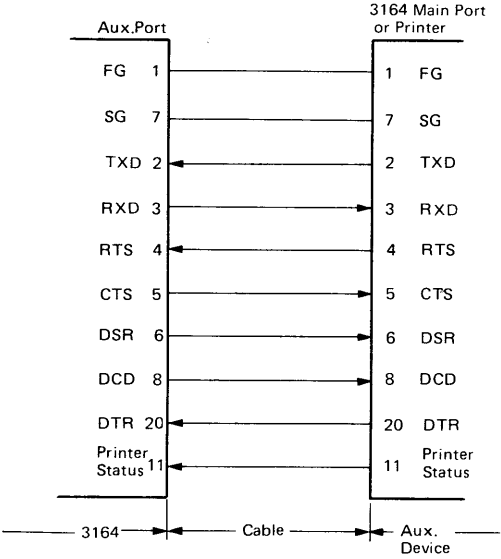

Chapter 5. Programming considerations

46	Monitor Printer Status (continued)	<p>This option is used to specify a printer ready condition. One of the following combinations can be selected for the printer ready state:</p> <table border="1" data-bbox="688 325 1356 634"> <thead> <tr> <th>Printer Status</th> <th>DTR</th> <th>Note</th> </tr> </thead> <tbody> <tr> <td>N.A.</td> <td>N.A.</td> <td rowspan="4">No signals are monitored.</td> </tr> <tr> <td>0 (+)</td> <td>0 (+)</td> </tr> <tr> <td>0 (+)</td> <td>1 (-)</td> </tr> <tr> <td>1 (-)</td> <td>0 (+)</td> </tr> <tr> <td>1 (-)</td> <td>1 (-)</td> <td rowspan="2">DTR is not monitored.</td> </tr> <tr> <td>0 (+)</td> <td>N.A.</td> </tr> <tr> <td>1 (-)</td> <td>N.A.</td> <td>DTR is not monitored.</td> </tr> <tr> <td>N.A.</td> <td>0 (+)</td> <td>Printer Status signal is not monitored.</td> </tr> <tr> <td>N.A.</td> <td>1 (-)</td> <td>Printer Status signal is not monitored.</td> </tr> </tbody> </table> <p>For instance, if you specify printer status = 0 (+) and DTR = 0 (+), the printer is considered ready when two signals are 0.</p> <p>If N.A. is applied to both the Printer Status and the DTR signals, print operation is always initiated regardless of the printer status.</p> <p>The last combination (Printer Status: N.A., DTR: 1(-)) is valid for the IBM 3164 attachment.</p>	Printer Status	DTR	Note	N.A.	N.A.	No signals are monitored.	0 (+)	0 (+)	0 (+)	1 (-)	1 (-)	0 (+)	1 (-)	1 (-)	DTR is not monitored.	0 (+)	N.A.	1 (-)	N.A.	DTR is not monitored.	N.A.	0 (+)	Printer Status signal is not monitored.	N.A.	1 (-)	Printer Status signal is not monitored.
Printer Status	DTR	Note																										
N.A.	N.A.	No signals are monitored.																										
0 (+)	0 (+)																											
0 (+)	1 (-)																											
1 (-)	0 (+)																											
1 (-)	1 (-)	DTR is not monitored.																										
0 (+)	N.A.																											
1 (-)	N.A.	DTR is not monitored.																										
N.A.	0 (+)	Printer Status signal is not monitored.																										
N.A.	1 (-)	Printer Status signal is not monitored.																										

Using the Viewport/Window/Partition/Page Control commands

Using the Create Viewport command

You can divide the screen into rectangular areas called *viewports* by using the Create Viewport command from the host system. You can specify the viewport type and the viewport identifier (VID) in this command to get the kind of viewport you want. You can create a maximum of three viewports with each viewport having a unique viewport identifier (VID) value between 1 and 3.

The following figures show all possible combinations of the viewport layout.

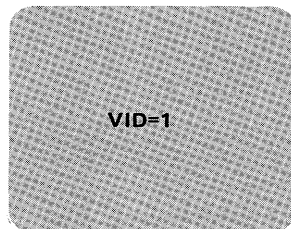

Viewport type 1

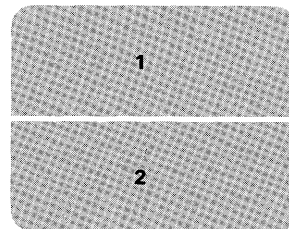

Viewport type 2

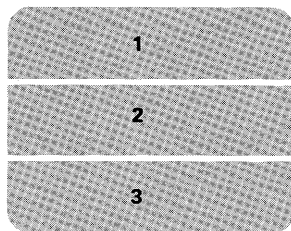

Viewport type 3

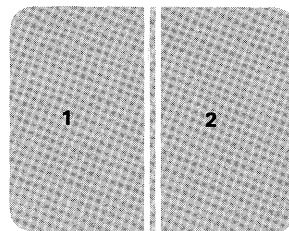

Viewport type 4

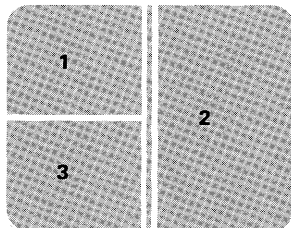

Viewport type 5

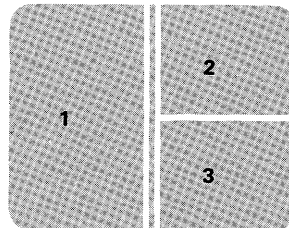

Viewport type 6

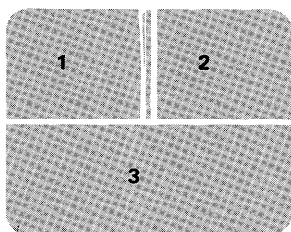

Viewport type 7

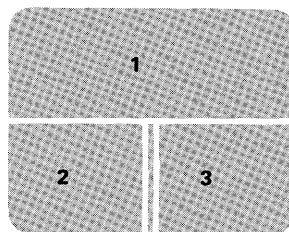

Viewport type 8

After power-on, viewport type 1 is assumed until you specify a different viewport type on the host program.

Chapter 5. Programming considerations

A viewport on the screen is defined by the following parameters:

- D_v and W_v specify the depth and width of the viewport, respectively.
- R_v and C_v specify the row and column of the viewport, respectively. Since R_v and C_v represent offset values, they are one less than the absolute row and column numbers of the viewport origin. For example, to place the viewport origin in the top left corner of the screen, you should specify $R_v=0$ and $C_v=0$.

The following figure shows the relationship between the viewport and partition.

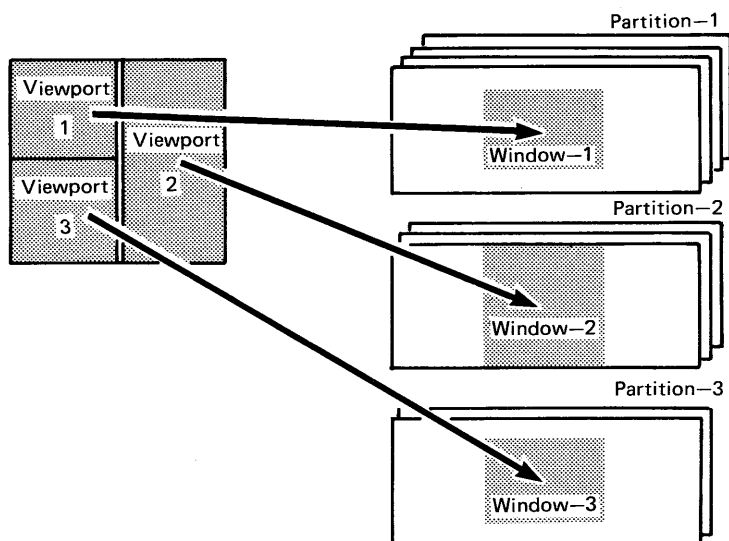

Now, let's write a program for making a screen (viewport type 2) like the one shown below with the following values.

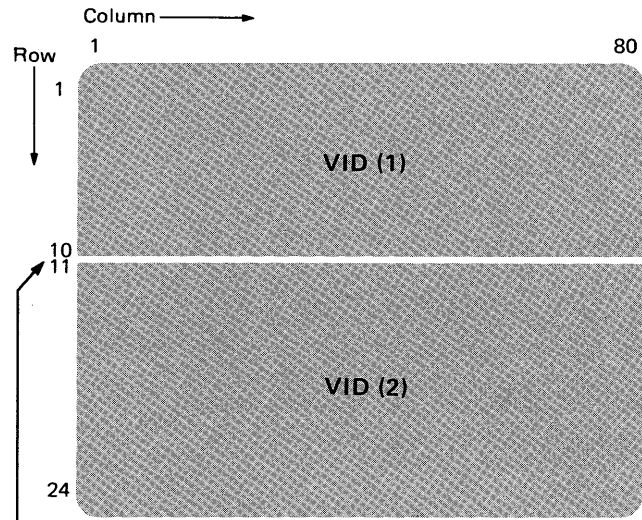

In the vertical dimension, viewports should occupy adjacent rows.

For viewport 1: $D_v = 10, W_v = 80, (R_v = 00, C_v = 00)$
 For viewport 2: $D_v = 14, W_v = 80, (R_v = 10, C_v = 00)$

The Create Viewport command looks like this:

Format: ESC space r Vt Vid Vdh Vdl Vwh Vwl
 Vid Vdh Vdl Vwh Vwl
 Vid Vdh Vdl Vwh Vwl

Parameter: Vt; Viewport Type
 (1 thru 8)
 Vid; Viewport ID (1 thru 3)
 Vdh,Vdl; Viewport Depth (Dv)
 Vwh,Vwl; Viewport Width (Wv)

Use the **ASCII Line Code Table** on page 5-79 to obtain the hexadecimal values for **ESC space r**. Also use the **Two Byte Parameter Table** on page 5-82 to obtain the hexadecimal values for the two viewports. Your coding should look like this:

```
1B 20 72 22 21 20 2A 22 30
22 20 2E 22 50
```

Chapter 5. Programming considerations

Next, let's write a program for making a screen like the one shown below which happens to be viewport type 8.

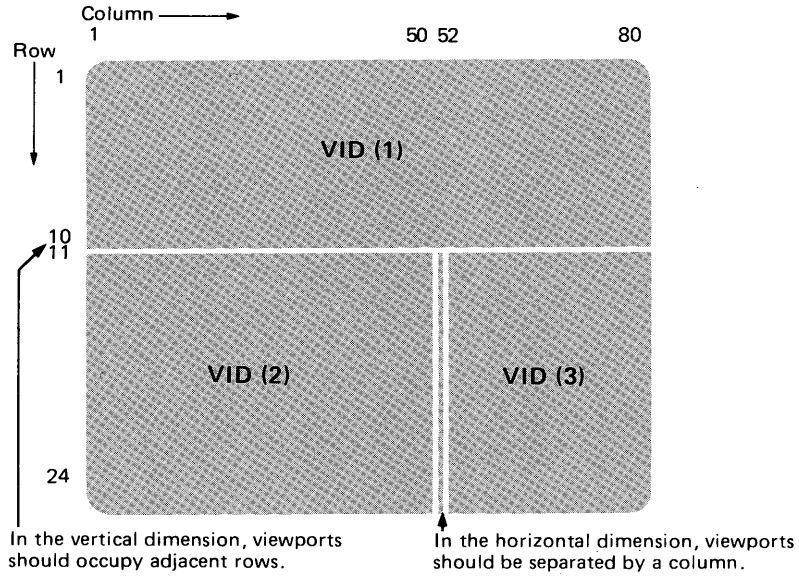

For viewport 1: $Dv = 10, Wv = 80, (Rv = 00, Cv = 00)$
For viewport 2: $Dv = 14, Wv = 50, (Rv = 10, Cv = 00)$
For viewport 3: $Dv = 14, Wv = 29, (Rv = 10, Cv = 51)$

Use the **ASCII Line Code Table** on page 5-79 to obtain the hexadecimal values for **ESC space r**. Also use the **Two Byte Parameter Table** on page 5-82 to obtain the hexadecimal values for the three viewports. Your coding should look like this:

```
1B 20 72 28 21 20 2A 22 30
   22 20 2E 21 32
   23 20 2E 20 5D
```

Using the Create Partition/Page command to create the partition/page

Each viewport that you saw in the previous section has an independent character buffer called a *partition*. A partition is made by the Create Partition/Page command in the application program. You can organize the data in a partition into fields having different attributes, such as protected, unprotected, display, non-display, etc. A partition containing fields is a formatted partition; a partition containing no fields is an unformatted partition. You can create up to three partitions. Each partition identifier (PID) has a corresponding viewport identifier (VID) and all data in that partition are displayed in the corresponding viewport.

Each partition can have up to four blocks of data called *pages*, with each page having a unique page identifier (GID) from 1 to 4. All pages with the same partition must have the same dimensions (rows and columns). The buffer addresses for each page are also controlled independently (in the same way as the partition). If the partition contains only a single page, the partition can be called a page and vice versa.

An area of the page equivalent in size to the viewport is called a *window* and only one window exists for a page. You can select the window to be displayed on the viewport either from the keyboard or from the host system.

The following figure shows the relationship between the partition, page, viewport, and window.

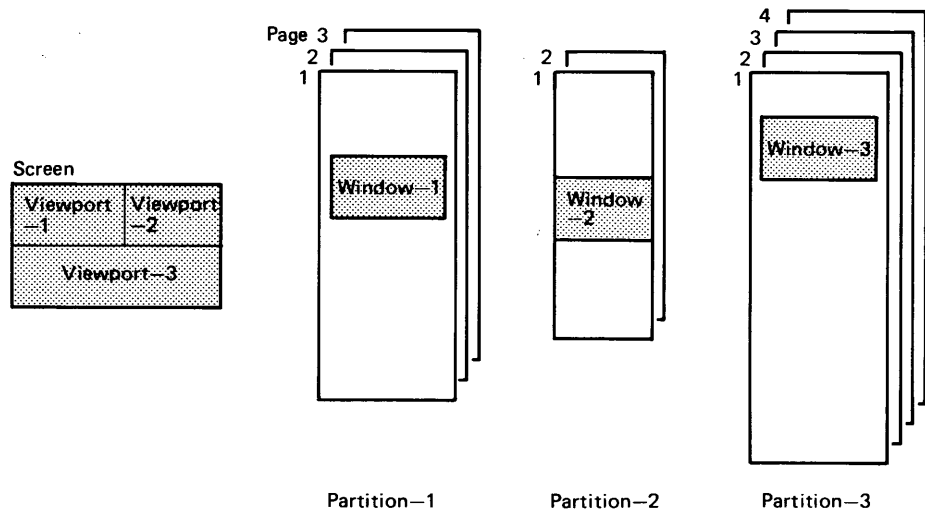

Chapter 5. Programming considerations

The figure below shows the windowing operation of the display station.

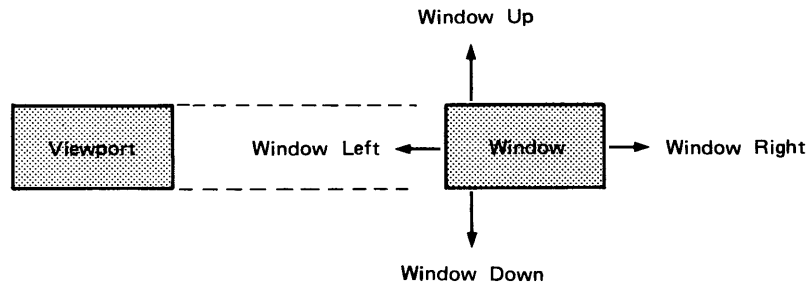

Notes:

- 1. After power-on, only one partition or page is assumed; it has the same dimensions as the screen.*
- 2. The row/column values defining the page width/depth are in the range from 1 to 255.*
- 3. The character buffer can hold a maximum of 7680 characters. For example, in the case of the viewport type 1, 4 pages with 24 rows by 80 columns or 1 page with 96 rows by 80 columns is allowed in the character buffer.*

Now, let's write a program for making a partition for the viewport (type 2) which we made previously.

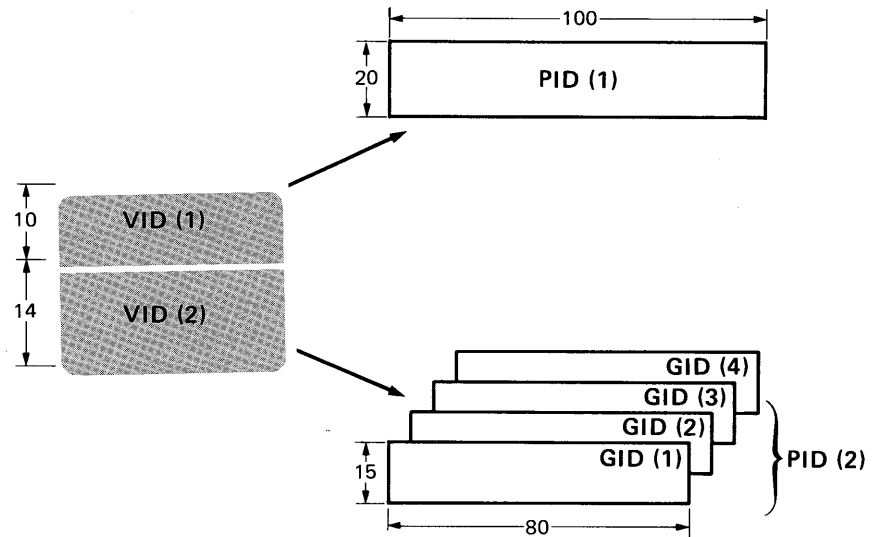

Let's assume the following conditions:

- Partition depth for partition ID 1 = 20,
- Partition width for partition ID 1 = 100,
- Number of pages for partition ID 1 = 1,
- Partition depth for partition ID 2 = 15,
- Partition width for partition ID 2 = 80,
- Number of pages for partition ID 2 = 4.

The Create Partition/Page command looks like this:

Format: ESC q Pid Pdh Pdl Pwh Pwl Pg
 Pid Pdh Pdl Pwh Pwl Pg
 Pid Pdh Pdl Pwh Pwl Pg

Parameter: Pid, Partition ID (1 thru 3)
 Pdh,Pdl; Page depth (1 thru 255)
 Pwh, Pwl; Page width (1 thru 255)
 Pg; Number of pages in a partition (1 thru 4)

Use the **ASCII Line Code Table** on page 5-79 to obtain the hexadecimal values for **ESC q**. Also use the **Two Byte Parameter Table** on page 5-82 to obtain the hexadecimal values for the two partitions/pages. Your coding should look like this:

```
1B 71 21 20 34 23 24 21
22 20 2F 22 30 44
```

Chapter 5. Programming considerations

Using the Window commands

You must define a window for each page of a partition. *Windowing* refers to the movement of the window along the page. As the window moves toward the beginning of the page, the data is moved down on the viewport. As the window moves toward the left margin of the page, the data is moved to the right on the viewport. The window can be moved up, down, left, or right on the page by:

The Up, Down, Left, and Right keys

The host program sending the Set Window Position, Window Up, Window Down, Window Right, and Window Left commands.

In addition, the windowing function is performed as a by-product of the current cursor address (CCA) movement. For example, when an Insert Cursor command from the host program moves the CCA out of the viewport, the display station moves the window along with the CCA so that the cursor remains within the viewport. This effect, in which a windowing action occurs as a by-product of CCA movement, is known as *auto-windowing*. Auto-windowing also occurs when the following keys are pressed:

- CR, LF, VT, HT, and FF control code keys
- Back Tab key
- Tab key
- Home key
- Clear key
- Erase Input key
- Return key
- Enter key
- Send Message key
- Send key
- Send Line key
- Graphic keys that cause the auto-skip function
- Graphic keys at the end of the viewport
- Graphic keys at the right margin of the viewport.

The following keys move the CCA within the window and the cursor within the viewport without causing auto-windowing:

- Backspace key
- Cursor Up/Down keys
- Cursor Left/Right keys.

Use the **Cursor and Buffer Address Table** on page 5-80 to obtain the parameter values (Prh, Prl, Pch, and Pcl) to be used in the Set Window command.

Using the Attribute Control commands

Every field or character you see on your screen has certain characteristics, such as protected or unprotected, to be displayed or not, etc. You can define these characteristics by using the Set Field Attribute command when defining an entire field, or by using the Set Character Attribute command when defining individual characters. If you are using the Program Color option, you can also define a field or character to be displayed in any of the 8 colors. Otherwise, they will be displayed in one of the 4 colors of red, green, blue, or white, depending on the combination of the protected and intensity bits of the field or character attribute. You can also define a line to have a double width and/or a double height using the Line Attribute commands. The table below shows the handling of field, character, and line attributes in each operating mode.

	Operating Mode		
	Echo	Char	Block
Field Color Attribute	NA	NA	X
Other Field Attributes	NA	NA	X
Character Color Attribute	X	X	X
Other Character Attributes	X	X	X
Line Attribute	X	X	X

NA: Not Applicable X: Supported

The priority by which the characteristics are chosen by the IBM 3164, except for the color attributes, is given in the table below.

Higher Priority	Lower Priority
Non-display FA/CA	Other FA/CA
Blink FA/CA	Non-blink FA/CA
Underline FA/CA	Non-underline FA/CA
Reverse FA/CA	Non-reverse FA/CA
High intensity FA/CA	Non-high intensity FA/CA

From the table above we can see that the non-display attribute has the highest priority; that is, the other attributes (blink, underline, reverse, high intensity) have no effect when the non-display FA or CA is applied.

For the color attributes, the priority of the character color attribute is higher than the field color attribute. The color of a character is controlled by the field color attribute only when the character color attribute is black. If a character is to be displayed in black, both the field and character color attributes must be black. The foreground color and the background color can be independently controlled. The high intensity FA/CA is ignored in Program Color mode.

Chapter 5. Programming considerations

After POR, the characters on the screen are displayed in the default character attributes of:

- Non-blinking
- Non-highlighting
- Non-reverse
- Non-underline
- Green characters on a black background.

The above characteristics remain effective until it is changed by the Set Character Attribute (SCA) command. from the host or the keyboard.

The character attributes specified from the host remain effective for characters input from the keyboard or sent from the host while the character attributes specified from the keyboard work only on characters input from the keyboard.

When a Set Character Attribute command is specified from the keyboard, only characters input from the keyboard use the keyboard character attribute while characters sent from the host use the host character attribute. To reset this state, you must specify the Reset Character Attribute (RCA) command from the host or keyboard.

When the Reset Character Attribute command is specified from the host or the keyboard, characters input from the keyboard are displayed in the character attribute currently effective at that character position

The diagram below shows how the character attributes will be changed by the SCA and RCA commands for characters input from the keyboard.

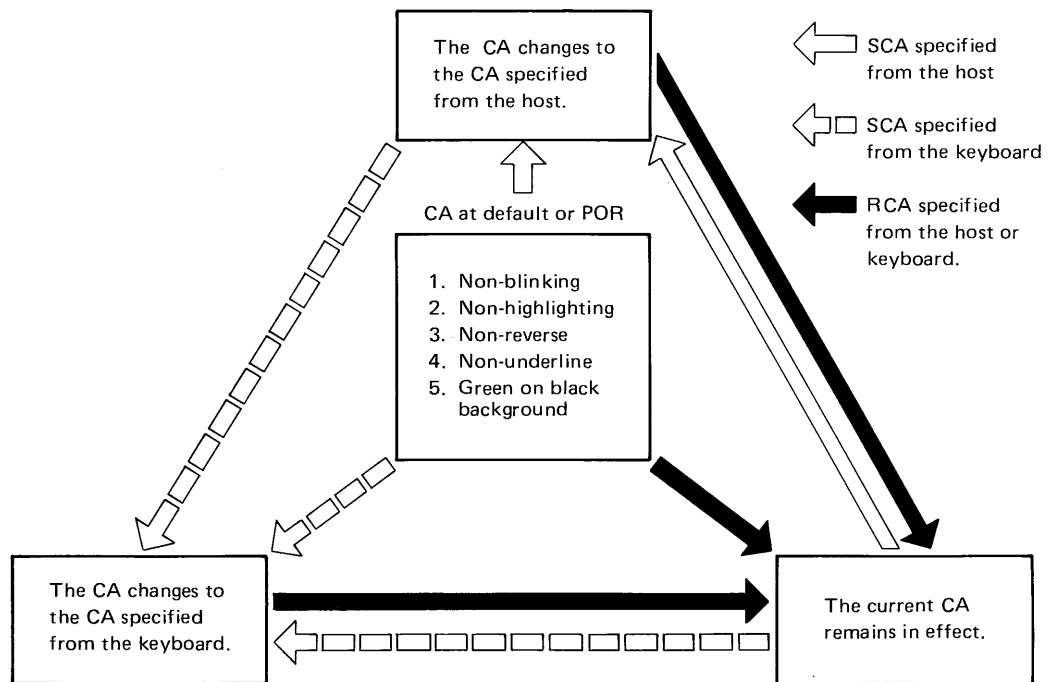

Using the Set Field Attribute command to set the field attributes

A field attribute occupies the first character position of each display field in a formatted page and is displayed in the same color as the background color. It defines the start of a field and also the characteristics of that field. A field consists of this field attribute and all the data following it, up to (but not including) the next field attribute. FA is effective only in block mode.

The figure below shows how a field attribute is stored in the character buffer.

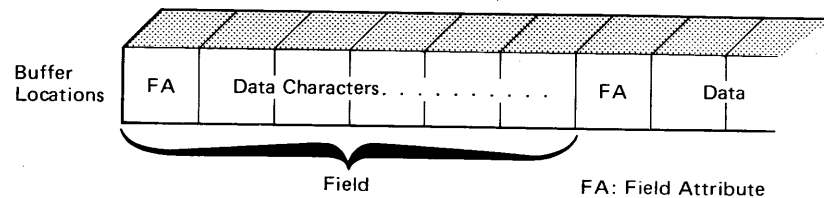

You can control the following characteristics of a field using the Set Field Attribute command.

A **non-display** field is a field in which characters entered or coming from the host are not displayed on the screen. This means that the characters (including the field attribute characters) are displayed in the same color as the background.

A **high intensity** field is a field in which the characters are displayed in either red or white in Default Color mode. This attribute is ignored in Program Color mode.

A **blink** field is a field in which the background color matches the foreground color in intervals. It appears as though the characters in the field are flashing on and off.

An **underline** field is a field in which the characters (including the null characters except for the attribute character positions) in the field are underscored.

A **reverse** field is a field in which the foreground color and the background color are inverted.

A **protected** field is a field that you cannot modify while an **unprotected** field is one that you can.

An **alphanumeric** field is the normal field you use in which you enter the alphabet and numbers while a **numeric** field is one in which you can enter only the numbers from 0 to 9, the decimal point (period), and the minus sign (-). You will see the indication NUMERIC at the bottom line of your screen. However, by using the Shift key, you can enter any uppercase character or symbol regardless of the NUMERIC indication.

Chapter 5. Programming considerations

A **modified data tag (MDT)** bit is used to identify a modified field during the send operation. Fields that you modify will have a MDT bit standing of 1 (on) in the field attribute character.

The MDT bit will be set to 1 (on) under the following conditions:

1. When the host program transmits the field attribute with the MDT bit set to 1 (on).
2. When you key-in a data character into a field.
3. When you use the Delete key/command or the Erase EOF key/command to delete characters.
4. When you use the Del Ln key/command to delete a line.
5. When you use the Ins Ln key/command to insert a line.

The MDT bit will be set to 0 (off) (that is, the field becomes unmodified) under the following conditions:

1. When the host program transmits the field attribute with the MDT bit set to 0 (off).
2. When you use the Er Inp key/command.
3. When you have completed the send or read operation successfully in the "modified field data transmission" mode. (Refer to page 5-5 for an explanation on this mode.)

A **right justified with zero or space** field is a field in which all data characters (including the space characters) in a field are right-adjusted when a cursor moves out of that field; that is, there is no null character between the last valid character and the next field attribute. The empty area on the left side of the data characters is automatically filled with zero or space characters according to the specified attribute. When the cursor moves after completion of the send operation, this function will be ignored.

A **must enter** field is a field in which the MDT bit must be set to 1 (on) before you transmit any data from the page. This means that you must modify that field specified as a 'must enter' field before performing the send operation. The display station performs a must-enter validation test when an operator enter action tries to initiate an inbound data transmission. The validation test searches the page, starting at the top, for an unprotected, must-enter field that has its MDT bit set to 0 (off).

- If such field is found, the cursor is moved to the first character position in that field, no transmission occurs, and the 'must enter' condition is raised so that the operator can modify the field and repeat the enter action; the display station then repeats the must-enter validation test.
- If no such field is found, the inbound data transmission is allowed to take place. The must-enter validation test allows transmission to take place only when all unprotected must-enter fields in the page have their MDT bits set to 1 (on).

A **must fill** field is a field which must be filled with characters other than a null character before you can move the cursor out of the field or transmit data from the page. The cursor can be moved into and out of that field at any time

if it has not been modified yet. In this case, the must-fill validation test does not take place.

The display station performs a must-fill validation test when the cursor is in a must-fill field whose contents have been already modified and you perform either of the following:

1. When you try to move the cursor out of the field.
2. When you try to initiate an inbound data transmission.

The must-fill validation test searches the must-fill field for null characters.

- If a null character is found, the keystroke that caused the validation test is not processed, the cursor is not moved out of the field, and the Must Fill condition is raised. You can fill the field with non-null characters, and then move the cursor out of the field or repeat the enter action; the display station then repeats the must-fill validation test.
- If no null character is found, then the keystroke that caused the validation test is processed normally.

Notes:

1. *Right Justified, Must Fill, and Must Enter have no effect if specified for a protected field.*
2. *If a field is classified as a must-fill/must-enter field and as an auto-send field, the must-fill/must-enter validation test is performed before the auto-send field action.*
3. *Use of the Page or Jump key is independent of the must-fill validation test. If you switch to another page or partition while the cursor is in an unmodified must-fill field, the screen cursor leaves the field, but the CCA for the page is not changed and the must-fill validation test is not performed. When you switch back to the original page or partition, the original situation is recreated as if the screen cursor had never left the page or partition.*
4. *The must-fill/must-enter validation test is applied to the field between the send starting and ending addresses.*

An **auto send** field is a field whose data are automatically sent to the host program as soon as you have modified a field (if the field data transmission mode is set to the modified field data transmission mode) and you move the cursor out of that field; this allows the host program to receive and to validate fields one by one.

Chapter 5. Programming considerations

Using the Set Character Attribute command to set the character attributes

The Set Character Attribute command performs functions similar to the Set Field Attribute command except that it works on single characters and not on the whole field. In addition, the CA does not occupy a character position on the screen. CA is effective in all modes; echo, character, and block modes.

Character attributes are not positional; the character position to which they refer is not fixed in the page, as is the case with a field. They are tied to their characters and are deleted and inserted with them.

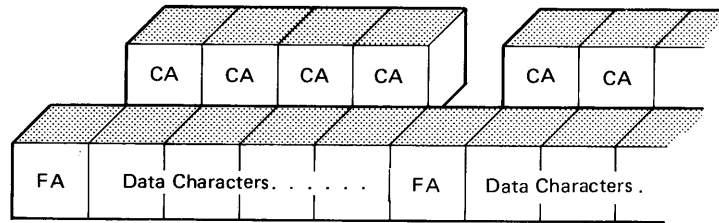

CA = Character Attribute
FA = Field Attribute

You can control the following characteristics of a character using this command.

A **non-display** character is a character entered from the keyboard or coming from the host which is not displayed in a field.

A **high intensity** character is a character which appears in either red or white on the screen in Default Color mode. This attribute is ignored in Program Color mode.

A **blink** character is a character in which the background matches the foreground color in intervals. It appears as though the characters in the field are flashing on and off.

An **underline** character is a character which is individually underscored.

A **reverse** character is a character in which the foreground color and the background color are inverted.

Using the Set Character/Field Attribute commands to adjust color

Foreground color is a color attribute usually assigned to a graphic character while background color is a color attribute usually assigned to the surrounding box. These color attributes can be changed or inverted as in the reverse video by specifying color in the character and field attributes.

In **Default Color** mode, the terminal displays characters in the four colors of red, green, blue, and white. Which color will be displayed for that field or character will depend on the following field attribute (FA) and character attribute (CA) combinations.

Foreground Color	Combination of FA/CA
Green	Unprotected and normal display
Blue	Protected and normal display
Red	Unprotected and high intensity
White	Protected and high intensity

In Default Color mode, all field characteristics except the color attributes, are effective; for example, the character in white or blue will be protected from modification by the operator. This means that the color attributes you specify in the field and character attributes are ignored.

Once you have enabled the **Program Color** mode using the Set Control 2 command, all characters and fields can be displayed in one of the following eight colors. The foreground and background colors can be independently controlled.

- Black (default of background)
- Red
- Green (default of foreground)
- Yellow
- Blue
- Magenta (Purple)
- Turquoise (Light Blue)
- White.

The high intensity attribute is ignored and the underline appears in the same color as the foreground.

In both the Default Color and Program Color modes, the underline cursor appears in white and the block cursor inverts the background and foreground colors. The divider line appears in blue and character/symbols in the operator information area in green. For a reverse attribute, the background and foreground colors are reversed.

If the page is formatted in Program Color mode, black and green are used as the default background and foreground colors, respectively.

Chapter 5. Programming considerations

Using the Line Attribute commands to set the line attributes

You can use the line attribute to specify the following characteristics of a line:

- Single height and single width (SHSW)
- Single height and double width (SHDW)
- Double height and single width (DHSW)
- Double height and double width (DHDW).

A line attribute does not occupy a character position on the screen. If no line attribute is specified, the SHSW line attribute is implicitly assumed.

Only the host program can change the height and width of all characters within a line on a line-by-line basis. A line attribute is allowed only when the width of the viewport is 80, since a line attribute is controlled on a line-by-line basis. The following is a list of viewports in which a line attribute is allowed:

- In VID (1) of viewport type 1
- In VID (1) and (2) of viewport type 2
- In VID (1), (2), and (3) of viewport type 3
- In VID (3) of viewport type 7
- In VID (1) of viewport type 8.

If the line attribute is specified in an invalid viewport, it causes a command reject. For the viewport types, refer to page 5-51.

Host messages that appear in the operator information area can be displayed either in SHSW or SHDW.

Note: The cursor/buffer address conforms to the character position in the page buffer, even if the double height/width characters are displayed. This means that, in case of DHDW, the four character positions are occupied in the character buffer, and the upper left character position should be addressed as a DHDW character.

A **double-height** line contains characters twice as high as standard characters. If the host redefines a line as double-height, the next lower line disappears from the viewport and is destroyed in the character buffer. The following figure illustrates the concept of the double-height control:

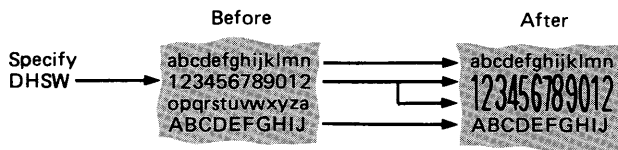

If the DHSW or DHDW attribute is specified on the bottom line of the viewport in CA mode, "auto-windowing" occurs. If it is the bottom line of the

page and the scroll function is enabled, the scroll-up occurs to display the double-height characters. If the scroll function is disabled, the command is rejected.

As a result of windowing, the top or bottom half characters might be displayed at the bottom or top line, respectively, in the viewport.

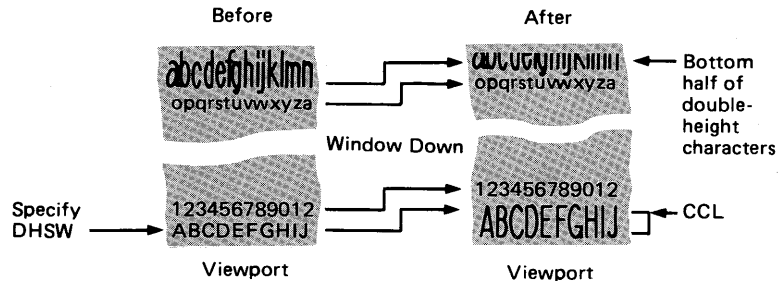

As a result of scrolling, if the top half of a double-height line is shifted out, the remaining single-height line is replaced with a line of null characters.

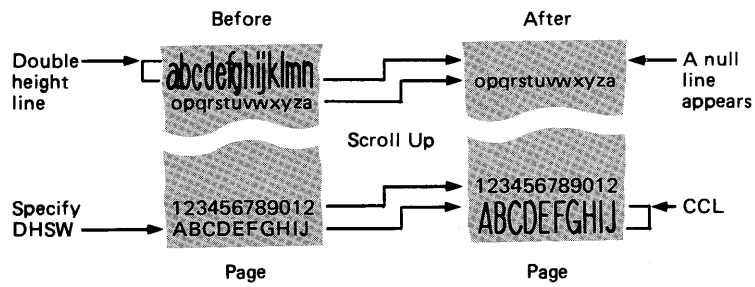

When the bottom (or top) half of the double-height line is displayed on the top (or bottom) row, the cursor movement to the top (or bottom) row causes auto-windowing to occur to display all characters of the double height line. The following figure shows an example.

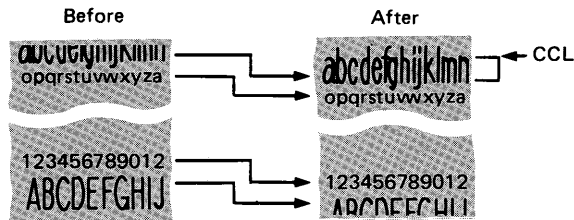

A **double-width** line contains characters twice as wide as standard characters. Using a double-width line means that only one-half of the line in the window can fit on the corresponding line of the viewport; if a line is defined as an 80-character double-width line, only the left 40 double-width characters can be displayed on that line.

The cursor cannot move into the unused area at the right-hand side of the double-width line in the window.

Chapter 5. Programming considerations

If the host program changes a line from single-width to double-width after the operator has entered data, all characters previously displayed at the right-hand side of the viewport are lost. The following figure illustrates the concept of double-width operation.

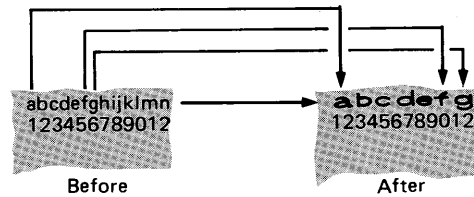

If the number of columns in the viewport is odd and the window reaches the rightmost position, the rightmost column is converted to a null character in the viewport. If the window is not located at the rightmost position, the left half of the double-width character appears at the rightmost column in the viewport. The following figure shows an example.

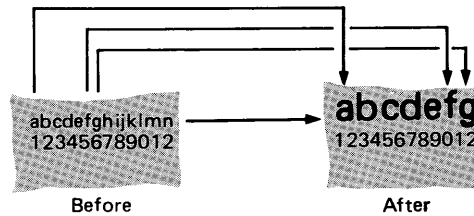

Using the Cursor Address and Buffer Address commands

There are two addressing modes for the 3164. The cursor address is specified by the Cursor Address (CA) command. The buffer address is specified by the Buffer Address (BA) command.

The cursor address allows a character entered from the keyboard or received from the host to be stored at the cursor position on the display. After the display terminal is powered-on, the cursor address and the buffer address is at the same position; the top of the screen. The current buffer address (CBA) is set initially to the current cursor address (CCA) until the Set Buffer Address (SBA) or the Extended Set Buffer Address (XSBA) command is received from the host. Once the display station enters the buffer address mode, data received from the host is handled by the BA. The host can send a character and display it without changing the cursor position, if the display is controlled by the buffer address. The character received is stored at the specified buffer address. The buffer address increases its value by 1 upon receipt of the character. The cursor address is not used and does not change. The display station remains in BA mode until the following command is received.

- Cursor Move (Up, Down, Right, Left, or Home) command
- Insert Cursor (IC) command
- Reset Buffer Address Mode command
- Set Cursor Address (SCA) command
- Extended Set Cursor Address (XSCA) command

However the last BA remains unchanged.

During the keyboard operation, the CCA is always used, regardless of the buffer address maintained by the host.

To locate a desired cursor address or buffer address, refer to the **Cursor and Buffer Address Table** on page 5-80.

Chapter 5. Programming considerations

Using the Keyboard Control commands

Using the Load Alternate Character command

You can create up to 94 symbols of your own choice and load them onto your IBM 3164 using the Load Alternate Character command from the host system. The symbols can include foreign language letters, mathematical and scientific symbols, and special type of fonts such as bold and italic as shown below.

Л π B I

In addition, the user can also define shapes or patterns that, when combined with other such shapes in adjoining character positions on the screen, will create a graphic representation.



On the display station, each character is represented by a pattern of dots selected from a matrix. Each dot within the matrix is known as a point. Characters are normally represented by predefined patterns accessed by character codes in the data stream that is sent to the display station.

The Alternate Character function allows you to define your own dot patterns within the character matrices. This function provides storage and accessing for one set containing 94 user-definable characters or symbols with a line code value in the range of X'21' through X'7E'. Each symbol has 8 points horizontally by 16 points vertically. Each horizontal 8-dot row is divided into two 4-dot cells, and each character is composed of 32 cells. The following figure illustrates this situation.

	1	2	3	4	5	6	7	8
1	1							17
2	2							18
3	3							19
.	.							.
.	.							.
.	.							.
15	15							31
16	16							32

To display the symbol, just press the corresponding key on your keyboard, and the Shift key if required. The storage space on your display station which stores these symbols is erased when you switch the power off on the display station, use Reset Initial State (RIS) command, or turn the Test/Normal switch to Test.

Alternate Character Design Sheet

Conversion Table

BINARY	HEX
0000	0
0001	1
0010	2
0011	3
0100	4
0101	5
0110	6
0111	7
1000	8
1001	9
1010	A
1011	B
1100	C
1101	D
1110	E
1111	F

	1	2	3	4	5	6	7	8
1								
2								
3								
4								
5								
6								
7								
8								
9								
10								
11								
12								
13								
14								
15								
16								

	1	2	3	4	5	6	7	8
1								
2								
3								
4								
5								
6								
7								
8								
9								
10								
11								
12								
13								
14								
15								
16								

	1	2	3	4	5	6	7	8
1								
2								
3								
4								
5								
6								
7								
8								
9								
10								
11								
12								
13								
14								
15								
16								

	1	2	3	4	5	6	7	8
1								
2								
3								
4								
5								
6								
7								
8								
9								
10								
11								
12								
13								
14								
15								
16								

	1	2	3	4	5	6	7	8
1								
2								
3								
4								
5								
6								
7								
8								
9								
10								
11								
12								
13								
14								
15								
16								

	1	2	3	4	5	6	7	8
1								
2								
3								
4								
5								
6								
7								
8								
9								
10								
11								
12								
13								
14								
15								
16								

	1	2	3	4	5	6	7	8
1								
2								
3								
4								
5								
6								
7								
8								
9								
10								
11								
12								
13								
14								
15								
16								

	1	2	3	4	5	6	7	8
1								
2								
3								
4								
5								
6								
7								
8								
9								
10								
11								
12								
13								
14								
15								
16								

Chapter 5. Programming considerations

Alternate Character Load Map

Bits					b7	0	0	0	0	1	1	1	1
					b6	0	0	1	1	0	0	1	1
					b5	0	1	0	1	0	1	0	1
b4	b3	b2	b1	Hex 0	0	1	2	3	4	5	6	7	
				Hex 1									
0	0	0	0	0									
0	0	0	1	1									
0	0	1	0	2									
0	0	1	1	3									
0	1	0	0	4									
0	1	0	1	5									
0	1	1	0	6									
0	1	1	1	7									
1	0	0	0	8									
1	0	0	1	9									
1	0	1	0	A									
1	0	1	1	B									
1	1	0	0	C									
1	1	0	1	D									
1	1	1	0	E									
1	1	1	1	F									

Here is an example of how to create and load a scientific symbol onto the Alternate Character set from your host system using the Load Alternate Character command.

Step 1. Make a copy of the Alternate Character Design Sheet and write down the pattern of the scientific symbol.

	1	2	3	4	5	6	7	8
1								
2								
3								
4								
5								
6		•	•	•	•			
7		•					•	
8	•							•
9	•							•
10	•							•
11	•							•
12		•					•	
13	•	•	•			•	•	•
14								
15								
16								

Step 2. Assign the scientific symbol to position '42' on the Alternate Character Load Map which is equivalent to the capital b key on the ASCII Line Code Table on page 5-79.

Bits	b7							
	0	0	0	0	1	1	1	1
	b6				b5			
	0	0	1	1	0	0	1	1
	b4 b3		b2 b1		Hex 0			
	0	0	0	0	0	1	2	3
	Hex 1				Hex 2			
	0	1	2	3	4	5	6	7
0 0 0 0	0	NUL	DLE	SP	0	@	P	P
0 0 0 1	1	SOH	DC1	!	1	A	O	a
0 0 1 0	2	STX	DC2	"	2	B	R	b
0 0 1 1	3	ETX	DC3	=	3	C	H	c
0 1 0 0	4	EOT	DC4	\$	4	D	T	d
0 1 0 1	5	ENG	NAK	%	5	E	U	u
0 1 1 0	6	ACK	SYN	&	6	F	V	v
0 1 1 1	7	BEL	ETB	'	7	G	W	w
1 0 0 0	8	BS	CAN	(8	H	X	x
1 0 0 1	9	HT	EM)	9	I	Y	y
1 0 1 0	A	LF	SUB	.	.	J	Z	z
1 0 1 1	B	VT	ESC	+	:	K	[{
1 1 0 0	C	FF	F5	.	<	L	\	
1 1 0 1	D	CR	GS	.	=	M]	}
1 1 1 0	E	SO	RS	.	>	N	^	~
1 1 1 1	F	SI	US	/	?	O	_	o
								DEL

	1	2	3	4	5	6	7	8
1								
2								
3								
4								
5								
6		•	•	•	•			
7		•					•	
8	•							•
9	•							•
10	•							•
11	•							•
12		•					•	
13	•	•	•			•	•	•
14								
15								
16								

Chapter 5. Programming considerations

Step 3. Code the parameters. Your bit pattern and hexadecimal coding should look like this.

Parameters	ASCII Bit Position 7 6 5 4 3 2 1		Hex
Lch	01 0 01 0 0	---> '4' means	24
Lcl	01 0 00 1 0	---> '2' Line Code X'42'	22
Rp	10 0 01 0 0	---> Repeat the following 5 times ---	44
Dp	11 0 00 0 0	---> Dot Pattern '0000' <-----	60
Dp	11 0 00 1 1	---> Dot Pattern '0011'	63
Dp	11 0 01 0 0	---> Dot Pattern '0100'	64
Rp	10 0 00 1 1	---> Repeat the following 4 times ---	43
Dp	11 0 10 0 0	---> Dot Pattern '1000' <-----	68
Dp	11 0 01 0 0	---> Dot Pattern '0100'	64
Dp	11 0 11 1 0	---> Dot Pattern '1110'	6E
Rp	10 0 00 1 0	---> Repeat the following 3 times ---	42
Dp	11 0 00 0 0	---> Dot Pattern '0000' <-----	60
Rp	10 0 01 0 0	---> Repeat the following 5 times ---	44
Dp	11 0 00 0 0	---> Dot Pattern '0000' <-----	60
Dp	11 0 11 0 0	---> Dot Pattern '1100'	6C
Dp	11 0 00 1 0	---> Dot Pattern '0010'	62
Rp	10 0 00 1 1	---> Repeat the following 4 times ---	43
Dp	11 0 00 0 1	---> Dot Pattern '0001' <-----	61
Dp	11 0 00 1 0	---> Dot Pattern '0010'	62
Dp	11 0 01 1 1	---> Dot Pattern '0111'	67
Rp	10 0 00 1 0	---> Repeat the following 3 times ---	42
Dp	11 0 00 0 0	---> Dot Pattern '0000' <-----	60

Step 4. Load the scientific symbol using the Load Alternate Character command from the host system. The command format looks like this:

Format: ESC space = Lch Lcl (Rp)Dp (Rp)Dp ---- ESC = (outbound)
└──┬──┘ └──┬──┘
cell(s) cell(s)

Parameter: Lch: 2X]
 Lcl: 2Y] where XY is a line code

Rp: 4X or 5X is the number of cells to be repeated
 40 is repeat once (default)
 41 is repeat twice
 42 is repeat three times
 .
 .
 5F is repeat 32 times

Dp: 6X where X is a 4-dot cell

1B.20.3D.24.22.44.60.63.64.43.68.
64.6E.42.60.44.60.6C.62.
43.61.62.67.42.60.1B.3D

Step 5. After you have loaded the alternate character to the display station by host programming, check by:

- a. Pressing the **Alt Chr** key together with the **Ctrl** key.

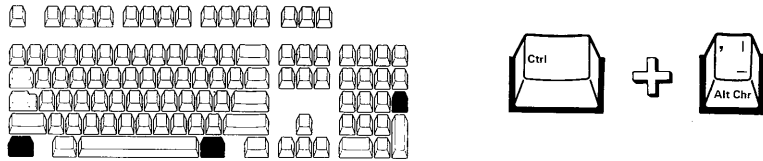

- b. Pressing the **B** key together with the **Shift** key.

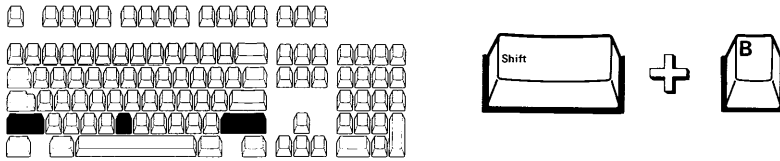

- c. The scientific symbol should be displayed at the present cursor position.

Chapter 5. Programming considerations

Using the Select Character Set command to select the character set

The display station supports two 94-graphic-character spaces addressable by line codes (21 through 7E). These two spaces are known as G0 and G1.

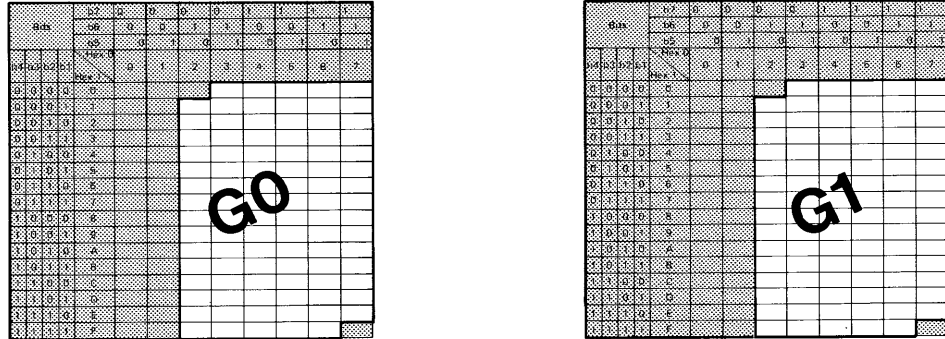

The host program can allocate two of the following character sets to G0 and G1 at a time:

- U.S. ASCII characters
- Special graphics
- Alternate characters.

The arrangement of the character sets in G0 and G1 spaces is controlled independently for the inbound and outbound operations.

In the inbound operation, the Select Character Set G0/G1 responses and SI/SO control characters are sent to the host as required when the character set is changed in relation to the Shift key operation.

In the case of the outbound operation, the Select Character Set (SCS) G0/G1 commands are used to assign the character set to G0/G1.

By using the Select Character Set G0/G1 commands and the SI/SO control characters, the host can display any character stored in the above two character sets. You can enter any character from the keyboard by using the appropriate shift (Alt Chr, Line Draw, and Shift) key.

In addition, each page can use the independent G0/G1; that is, the SCS G0/G1 commands and the SI/SO control characters are effective only in the outbound active page. For details on the SCS G0/G1 commands and responses, refer to the summary table of commands and responses earlier in this chapter.

The method of selecting the two active spaces G0 and G1 depends on the Word Length option you are presently using; the 7 bit or the 8 bit word length. The following tables illustrate how this works for the 7 bit and the 8 bit word length inbound and outbound operations.

7-bit mode operation

Once G0 and G1 are determined by the host system, the ASCII control characters SI and SO are used to switch G0 to G1 or G1 to G0; SI for G0 and SO for G1 are used to determine the current active character set. However, you cannot change the characters that are already displayed on the screen or stored in the character buffer. The following figure illustrates the concept of character set control.

Character Set Selection for Outbound Operation

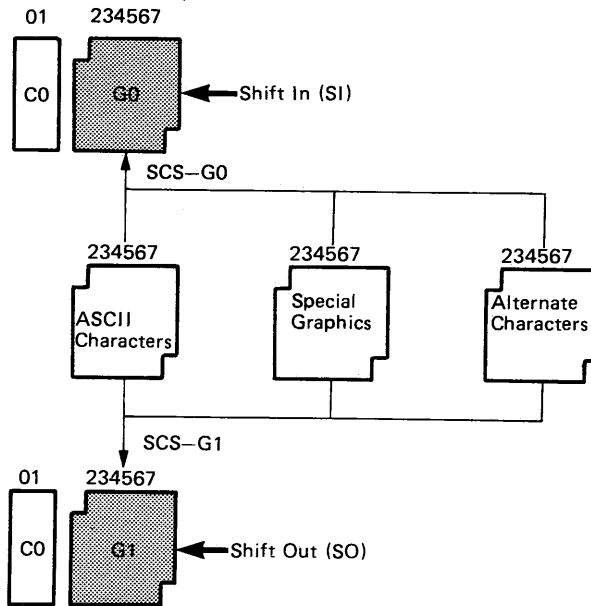

Character Set Selection for Inbound/Keyboard Operation

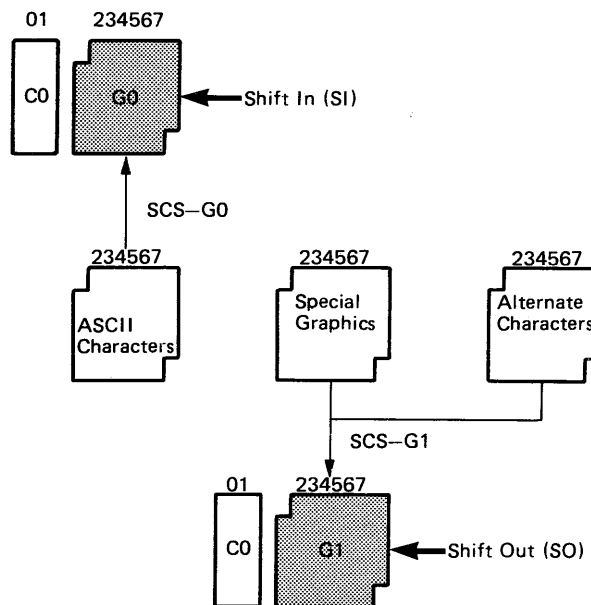

Chapter 5. Programming considerations

8-bit mode operation

In 8-bit mode, the most significant bit (MSB) is used to select G0/G1. In this case, SI and SO have no effect; they are simply ignored. The following figure shows the concept.

Character Set Selection for Outbound Operation

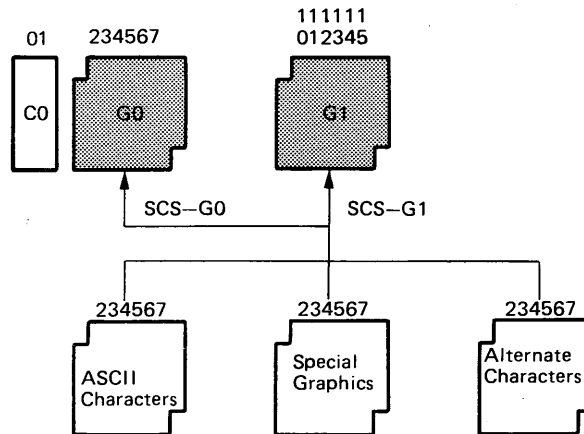

Character Set Selection for Inbound/Keyboard Operation

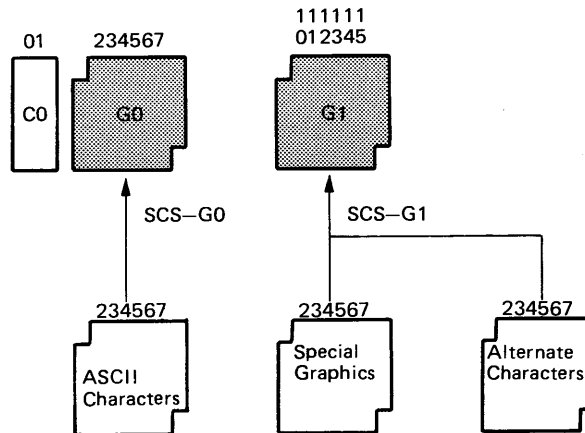

ASCII line code table

U.S. ASCII characters

Bits					b7	0	0	0	0	1	1	1	1
					b6	0	0	1	1	0	0	1	1
					b5	0	1	0	1	0	1	0	1
b4	b3	b2	b1	Hex 0	0	1	2	3	4	5	6	7	
Hex 1													
0	0	0	0	0	NUL	DLE	SP	0	@	P	`	P	
0	0	0	1	1	SOH	DC1	!	1	A	Q	a	q	
0	0	1	0	2	STX	DC2	"	2	B	R	b	r	
0	0	1	1	3	ETX	DC3	#	3	C	S	c	s	
0	1	0	0	4	EOT	DC4	\$	4	D	T	d	t	
0	1	0	1	5	ENG	NAK	%	5	E	U	e	u	
0	1	1	0	6	ACK	SYN	&	6	F	V	f	v	
0	1	1	1	7	BEL	ETB	'	7	G	W	g	w	
1	0	0	0	8	BS	CAN	(8	H	X	h	x	
1	0	0	1	9	HT	EM)	9	I	Y	i	y	
1	0	1	0	A	LF	SUB	*	:	J	Z	j	z	
1	0	1	1	B	VT	ESC	+	;	K	[k	{	
1	1	0	0	C	FF	FS	,	<	L	\	l		
1	1	0	1	D	CR	GS	-	=	M]	m	}	
1	1	1	0	E	SO	RS	.	>	N	^	n	~	
1	1	1	1	F	SI	US	/	?	O	-	o	DEL	

Special graphic characters

Bits					b7	0	0	0	0	1	1	1	1
					b6	0	0	1	1	0	0	1	1
					b5	0	1	0	1	0	1	0	1
b4	b3	b2	b1	Hex 0	0	1	2	3	4	5	6	7	
Hex 1													
0	0	0	0	0				0			0	█	
0	0	0	1	1				1			1	—	
0	0	1	0	2				2			2	▬	
0	0	1	1	3				3			3	▬	
0	1	0	0	4				4			4	┌	
0	1	0	1	5				5			5	└	
0	1	1	0	6				6			6	┘	
0	1	1	1	7				7			7	└	
1	0	0	0	8				8			8		
1	0	0	1	9				9			9		
1	0	1	0	A							┘	┐	
1	0	1	1	B							└	┐	
1	1	0	0	C				▶			┘	┐	
1	1	0	1	D				◀			┘	┐	
1	1	1	0	E				▲			+	█	
1	1	1	1	F				▼			█	█	

Chapter 5. Programming considerations

Cursor and buffer address table (base format)

Row Col	Hex Code	Graphic	Row Col	Hex Code	Graphic	Row Col	Hex Code	Graphic
1	20	Space	31	3E	>	61	5C	\
2	21	!	32	3F	?	62	5D]
3	22	"	33	40	@	63	5E	^
4	23	#	34	41	A	64	5F	~
5	24	\$	35	42	B	65	60	`
6	25	%	36	43	C	66	61	a
7	26	&	37	44	D	67	62	b
8	27	'	38	45	E	68	63	c
9	28	(39	46	F	69	64	d
10	29)	40	47	G	70	65	e
11	2A	*	41	48	H	71	66	f
12	2B	+	42	49	I	72	67	g
13	2C	,	43	4A	J	73	68	h
14	2D	-	44	4B	K	74	69	i
15	2E	.	45	4C	L	75	6A	j
16	2F	/	46	4D	M	76	6B	k
17	30	0	47	4E	N	77	6C	l
18	31	1	48	4F	O	78	6D	m
19	32	2	49	50	P	79	6E	n
20	33	3	50	51	Q	80	6F	o
21	34	4	51	52	R	81	70	p
22	35	5	52	53	S	82	71	q
23	36	6	53	54	T	83	72	r
24	37	7	54	55	U	84	73	s
25	38	8	55	56	V	85	74	t
26	39	9	56	57	W	86	75	u
27	3A	:	57	58	X	87	76	v
28	3B	;	58	59	Y	88	77	w
29	3C	<	59	5A	Z	89	78	x
30	3D	=	60	5B	[90	79	y
						91	7A	z
						92	7B	{
						93	7C	
						94	7D	}
						95	7E	~

Cursor and buffer address table (extended format)

Row Col	Code	Graphic	Row Col	Code	Graphic	Row Col	Code	Graphic
1	20, 20	Sp Sp	31	20, 3E	Sp >	61	21, 3C	! <
2	20, 21	Sp !	32	20, 3F	Sp ?	62	21, 3D	! =
3	20, 22	Sp "	33	21, 20	! Sp	63	21, 3E	! >
4	20, 23	Sp #	34	21, 21	! !	64	21, 3F	! ?
5	20, 24	Sp \$	35	21, 22	! "	65	22, 20	" Sp
6	20, 25	Sp %	36	21, 23	! #	66	22, 21	" !
7	20, 26	Sp &	37	21, 24	! \$	67	22, 22	" "
8	20, 27	Sp '	38	21, 25	! %	68	22, 23	" #
9	20, 28	Sp (39	21, 26	! &	69	22, 24	" \$
10	20, 29	Sp)	40	21, 27	! '	70	22, 25	" %
11	20, 2A	Sp *	41	21, 28	! (71	22, 26	" &
12	20, 2B	Sp +	42	21, 29	!)	72	22, 27	" '
13	20, 2C	Sp ,	43	21, 2A	! *	73	22, 28	" (
14	20, 2D	Sp -	44	21, 2B	! +	74	22, 29	")
15	20, 2E	Sp .	45	21, 2C	! ,	75	22, 2A	" *
16	20, 2F	Sp /	46	21, 2D	! -	76	22, 2B	" +
17	20, 30	Sp 0	47	21, 2E	! .	77	22, 2C	" ,
18	20, 31	Sp 1	48	21, 2F	! /	78	22, 2D	" -
19	20, 32	Sp 2	49	21, 30	! 0	79	22, 2E	" .
20	20, 33	Sp 3	40	21, 31	! 1	80	22, 2F	" /
21	20, 34	Sp 4	51	21, 32	! 2	81	22, 30	" 0
22	20, 35	Sp 5	52	21, 33	! 3	82	22, 31	" 1
23	20, 36	Sp 6	53	21, 34	! 4	83	22, 32	" 2
24	20, 37	Sp 7	54	21, 35	! 5	84	22, 33	" 3
25	20, 38	Sp 8	55	21, 36	! 6	85	22, 34	" 4
26	20, 39	Sp 9	56	21, 37	! 7	86	22, 35	" 5
27	20, 3A	Sp :	57	21, 38	! 8	87	22, 36	" 6
28	20, 3B	Sp ;	58	21, 39	! 9	88	22, 37	" 7
29	20, 3C	Sp <	59	21, 3A	! :	89	22, 38	" 8
30	20, 3D	Sp =	60	21, 3B	! ;	90	22, 39	" 9
						91	22, 3A	" :
						92	22, 3B	" ;
						93	22, 3C	" <
						94	22, 3D	" =
						95	22, 3E	" >
						96	22, 3F	" ?
						97	23, 20	# Sp
						.	.	
						.	.	
						.	.	
						255	27, 3E	' >

Chapter 5. Programming considerations

Two byte parameter table

Value	Code	Graphic	Value	Code	Graphic	Value	Code	Graphic
0	20, 20	Sp Sp	30	20, 3E	Sp >	60	21, 3C	! <
1	20, 21	Sp !	31	20, 3F	Sp ?	61	21, 3D	! =
2	20, 22	Sp "	32	21, 20	! Sp	62	21, 3E	! >
3	20, 23	Sp #	33	21, 21	! !	63	21, 3F	! ?
4	20, 24	Sp \$	34	21, 22	! "	64	22, 20	" Sp
5	20, 25	Sp %	35	21, 23	! #	65	22, 21	" !
6	20, 26	Sp &	36	21, 24	! \$	66	22, 22	" "
7	20, 27	Sp '	37	21, 25	! %	67	22, 23	" #
8	20, 28	Sp (38	21, 26	! &	68	22, 24	" \$
9	20, 29	Sp)	39	21, 27	! '	69	22, 25	" %
10	20, 2A	Sp *	40	21, 28	! (70	22, 26	" &
11	20, 2B	Sp +	41	21, 29	!)	71	22, 27	" '
12	20, 2C	Sp ,	42	21, 2A	! *	72	22, 28	" (
13	20, 2D	Sp -	43	21, 2B	! +	73	22, 29	")
14	20, 2E	Sp .	44	21, 2C	! ,	74	22, 2A	" *
15	20, 2F	Sp /	45	21, 2D	! -	75	22, 2B	" +
16	20, 30	Sp 0	46	21, 2E	! .	76	22, 2C	" ,
17	20, 31	Sp 1	47	21, 2F	! /	77	22, 2D	" -
18	20, 32	Sp 2	48	21, 30	! 0	78	22, 2E	" .
19	20, 33	Sp 3	49	21, 31	! 1	79	22, 2F	" /
20	20, 34	Sp 4	50	21, 32	! 2	80	22, 30	" 0
21	20, 35	Sp 5	51	21, 33	! 3	81	22, 31	" 1
22	20, 36	Sp 6	52	21, 34	! 4	82	22, 32	" 2
23	20, 37	Sp 7	53	21, 35	! 5	83	22, 33	" 3
24	20, 38	Sp 8	54	21, 36	! 6	84	22, 34	" 4
25	20, 39	Sp 9	55	21, 37	! 7	85	22, 35	" 5
26	20, 3A	Sp :	56	21, 38	! 8	86	22, 36	" 6
27	20, 3B	Sp ;	57	21, 39	! 9	87	22, 37	" 7
28	20, 3C	Sp <	58	21, 3A	! :	88	22, 38	" 8
29	20, 3D	Sp =	59	21, 3B	! ;	89	22, 39	" 9
						90	22, 3A	" :
						91	22, 3B	" ;
						92	22, 3C	" <
						93	22, 3D	" =
						94	22, 3E	" >
						95	22, 3F	" ?
						96	23, 20	# Sp
						.	..	
						
						
						1023	3F, 3F	??

This chapter gives you guidelines for preparing for the installation of the IBM 3164.

Environmental requirements 6-2

- Dimensions and clearances
- Display-station environment
- Operator workspace
- Ambient lighting
- Viewing distance
- Product and environmental safety
- Acoustic noise emission

Electrical requirements 6-6

- Input power
- Main port
- Auxiliary port
- Cable paths
- Electromagnetic influences
- Electrostatic discharge
- Lightning protection
- Cables

Chapter 6. Physical installation

Environmental requirements

Dimensions and clearances

The figure below gives the physical dimensions of each display-station element and the clearances required to operate and service the IBM 3164.

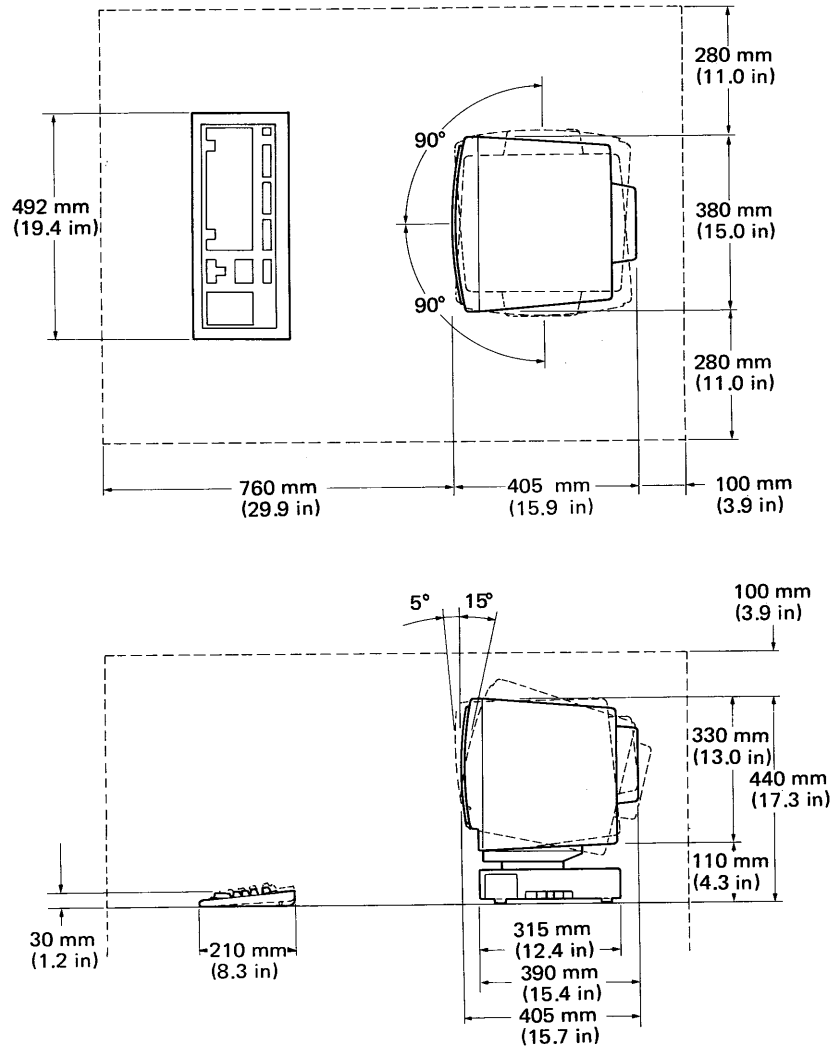

Note:

Right and left service clearances can be reduced to the minimum clearances required for IBM 3164 cooling and operating—10 centimeters (3.9 inches) on each side.

Dimensions

Video element	Width:	380 mm (15.0 in)
	Depth:	405 mm (15.9 in)
	Height with stand:	390 mm (15.4 in)
Logic element	Width:	345 mm (13.6 in)
	Depth:	315 mm (12.4 in)
	Height:	70 mm (2.8 in)
Keyboard	Width:	492 mm (19.4 in)
	Depth:	210 mm (8.3 in)
	Height:	40 mm (1.6 in)

Weight

Video element and stand	14.0 kg (30.9 lb)
Logic element	2.2 kg (4.9 lb)
Keyboard	2.5 kg (5.5 lb)

Note: For your safety, separate the video, logic, and keyboard elements when moving the display station to another location. The assembled display station is too heavy to carry.

Chapter 6. Physical installation

Display-station environment

The chart below shows the environmental requirements for the IBM 3164.

	Environment			
	Operating	Non-Operating	Storage	Shipment
Temperature	10 - 40.6°C (50 - 105°F)	10 - 51.7°C (50 - 125°F)	0.6 - 60°C (33 - 140°F)	-20.0 - 60°C (-4 - 140°F)
Relative Humidity	8 - 80%	8 - 80%	5 - 80%	5 - 100%
Max Wet Bulb	26.7°C (80°F)	26.7°C (80°F)	29.4°C (85°F)	29.4°C (85°F)
Max Elevation	2135 m (7000 ft)	—	—	—

Operator workspace

Following are the recommended dimensions or positions for planning the work-station layouts:

- Distance between operators: 122 to 152 centimeters (48 inches to 60 inches) preferred.
- Leg clearance while seated, minimum:
 - Width: 61 centimeters (24 inches)
 - Depth: 46 centimeters (18 inches)
 - Height: 64 centimeters (25 inches).
- Toe clearance for standing: 10 centimeters (3.9 inches) minimum.
- See-over height (top of display unit to floor):
 - Standing operator: 140 centimeters (55 inches) maximum.
 - Seated operator: 100 to 110 centimeters (40 to 43 inches).
- Writing surface:
 - 41 centimeters (16 inches) deep by 30 centimeters (12 inches) wide, minimum.
 - Allow 2.5 centimeters (1 inch) space between multiple sets of documents.

Ambient lighting

Average lighting of 540 to 810 lumens/meter² (50 to 75 footcandles) is recommended for most tasks requiring displays. Lights should be evenly distributed over the work area. The intensity of the light can be measured by a common luminance meter.

Viewing distance

Most operators will find that they can view the screen comfortably at a distance of 33 to 51 centimeters (13 to 20 inches). This distance, of course will depend on the individual's eyesight, visual conditions, work-station layout, and features of the reference or source material.

Product and environmental safety

The following safety factors should be considered:

- Emergency disconnection of power to the branch circuits serving the equipment.
- Clearances for both operating and service personnel (see the dimensions and clearances in this chapter). Access clearance for each IBM 3164 must be considered.
- Grounding of branch circuits.
- Lightning protection for power lines and signal lines.

The installation must meet local and national code requirements.

Acoustic noise emission

The following chart shows the typical noise emission values of the IBM 3164. These values are preliminary and are subject to change.

Acoustic Noise Emission									
Type	Description	LwAd		LpAm		<LpA>m		I	T
		Operating (dB)	Idling (dB)	Operating (dB)	Idling (dB)	Operating (dB)	Idling (dB)		
3164	DISPLAY TERMINAL	45	46	22	23	22	22	NO	NO
Notes:									
LwAd		is the declared sound power emission level production series of machines.							
LpAm		is the mean value of the sound pressure emission levels at the operator position (if any) for a production series of machines.							
<LpA>m		is the mean value of the space-averaged sound pressure emission levels at the one-meter positions for a production series of machines.							
I		Impulsive Noise. Entry is either Yes or No.							
T		Prominent Discrete Tones. Entry is either Yes or No.							
All measurements made in accordance with ISO DIS 7779, and reported in conformance with ISO DIS 7574/4.									

Chapter 6. Physical installation

Electrical requirements

Input power

The following chart shows the electrical requirements for the IBM 3164.

KVA	0.28 max.
Wattage	100 Watts
Phase	1
Frequency	60 ± 0.5 Hz
Amperage	2.3A max.
Voltage	120 Vac
Power Cord Length	2.8 m (9 ft)
Plug Type	See "Cables"

Main port

The main port is used for communicating with a host line and its operation is governed by the following setup and host line conditions:

- Interface (RS-232C or RS-422A)
- Programmable line speed (50 - 19,200 bps)
- Inbound/outbound pacing (XOFF/XON)
- Operating mode (echo, character, or block)
- Word length (7 or 8 bits)
- Programmable parity (none/odd/even/mark/space)
- Programmable response timing
- Programmable line turnaround character (ETX/EOT/CR/DC3)
- LRC capability.

If you are using the **RS-232C** interface, you can communicate with the host system over the following facilities:

- PRTS (permanent request to send on full duplex communication facility)
- CRTS (controlled request to send on half duplex communication facility)
- IPRTS (induced permanent request to send on full duplex communication facility).

The maximum length of the communication (shielded) cable when using this interface is 12 meters (40 feet).

If you are using the **RS-422A** interface, you can communicate with the host system directly, i.e. without modems. The maximum length of the communication (shielded, twisted, and paired) cable when using this interface is 1.2 kilometers (4000 feet).

Both of these interfaces use the **EIA 25-pin** connector in common and share the same port. The pin assignment for this port is as follows:

Pin No.	Signal Name	Mnemonic	Direction	EIA RS-232C (4)			EIA RS-422A (4)
				CRTS	PRTS	IPRTS	
1	Protective Ground	FG		X	X	X	X
2	Transmit Data	TXD	Out	X	X	X	
3	Receive Data	RXD	In	X	X	X	
4	Request to Send	RTS	Out	X	X(1)	X(1)	
5	Clear to Send	CTS	In	X	X	(2)	
6	Data Set Ready	DSR	In	X	X	(2)	
7	Signal Ground	SG		X	X	X	X
8	Data Carrier Detect	DCD	In	X	X	X	
9	(Not Used)						
10	(Not Used)						
11	(Not Used)						
12	(Not Used)						
13	(Not Used)						
14	(Not Used)						
15	Receive +		In				X
16	(Not Used)						
17	Receive -		In				X
18	(Not Used)						
19	Send +		Out				X
20	Data Terminal Ready	DTR	Out	X(3)	X(3)	X(3)	
21	(Not Used)						
22	(Not Used)						
23	(Not Used)						
24	(Not Used)						
25	Send -		Out				X

- Notes:
- X Used
 - (1) Always set to on
 - (2) No Check: assumed to be on.
 - (3) Always set to on except when DEL.EOT is received
 - (4) Selected by model/setup

Auxiliary port

The auxiliary port is used for communicating with an auxiliary input/output device such as a terminal or printer and its operation is governed by the following setup and host link conditions:

- Interface (RS-232C)
- Word length (7 or 8 bits)
- Inbound/outbound pacing (XOFF/XON)
- Programmable line speed (50 - 19,200 bps)
- Programmable parity (none/odd/even/mark/space)
- Print commands (Print Page, Print Line, Print Message)
- Programmable trace
- Monitor printer status
- Operator-initiated local print
- Host initiated print
- Passthrough transmission.

Chapter 6. Physical installation

The RS-232C connector also uses the **EIA 25-Pin** connector. The assignment for this port is as follows:

Pin No.	Signal Name	Mnemonic	Direction	RS-232C
1	Protective Ground	FG		X
2	Transmit Data	TXD	In	X
3	Received Data	RXD	Out	X
4	Request to Send	RTS	In	X
5	Clear to Send	CTS	Out	X
6	Data Set Ready	DSR	Out	X
7	Signal Ground	SG		X
8	Data Carrier Detect (1)	DCD	Out	X
9	(Not Used)			
10	(Not Used)			
11	Printer Status (2)	STD	In	X
12	(Not Used)			
13	(Not Used)			
14	(Not Used)			
15	(Not Used)			
16	(Not Used)			
17	(Not Used)			
18	(Not Used)			
19	(Not Used)			
20	Data Terminal Ready (2)	DTR	In	X
21	(Not Used)			
22	(Not Used)			
23	(Not Used)			
24	(Not Used)			
25	(Not Used)			

- Notes:
- X Used
 - (1) Always set to on
 - (2) Used for the printer monitor.

The EIA 25-pin connector looks like this.

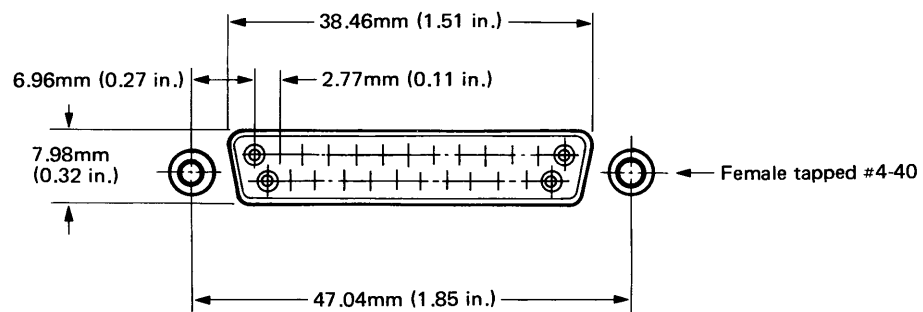

Cable paths

The paths of cables exiting from the IBM 3164 should be shown on the floor plan, with consideration given to the protection of cables, as well as the hazard these cables create by being on the floor.

Electromagnetic influences

The following could cause strong electromagnetism:

- Radio-frequency sources such as transmitting antennas (AM, FM, television, and two-way radios)
- Radar installations
- Industrial equipment (radio-frequency induction heaters, arc welders, and insulation testers)
- Three-phase power distribution lines
- Transformers
- Distribution panels
- Rotating machinery
- Electric floor heaters.

As a precaution, keep the IBM 3164 away from these magnetic sources. If you fail to do so, you may see distorted characters on your screen.

Electrostatic discharge

High electrostatic charges can build up on people and furniture as a result of:

- Contact with high-resistance, floor-surface material
- Contact with carpeting without antistatic properties
- Contact with plastic seat coverings
- Contact with metal-frame furniture
- Very low humidity.

So keep in mind that these electrostatic discharges to the metal of the IBM 3164 or to the furniture on which it is placed may affect the IBM 3164 as they do sometimes to other electronic equipment.

Lightning protection

You should plan on installing a lightning protector for your secondary power source when:

- Primary power is supplied by an overhead power service.
- The utility company does not install a lightning protector on your primary power source.
- The area is subject to electrical storms or similar power surges.

Chapter 6. Physical installation

Cables

The chart below shows the cabling for the IBM 3164.

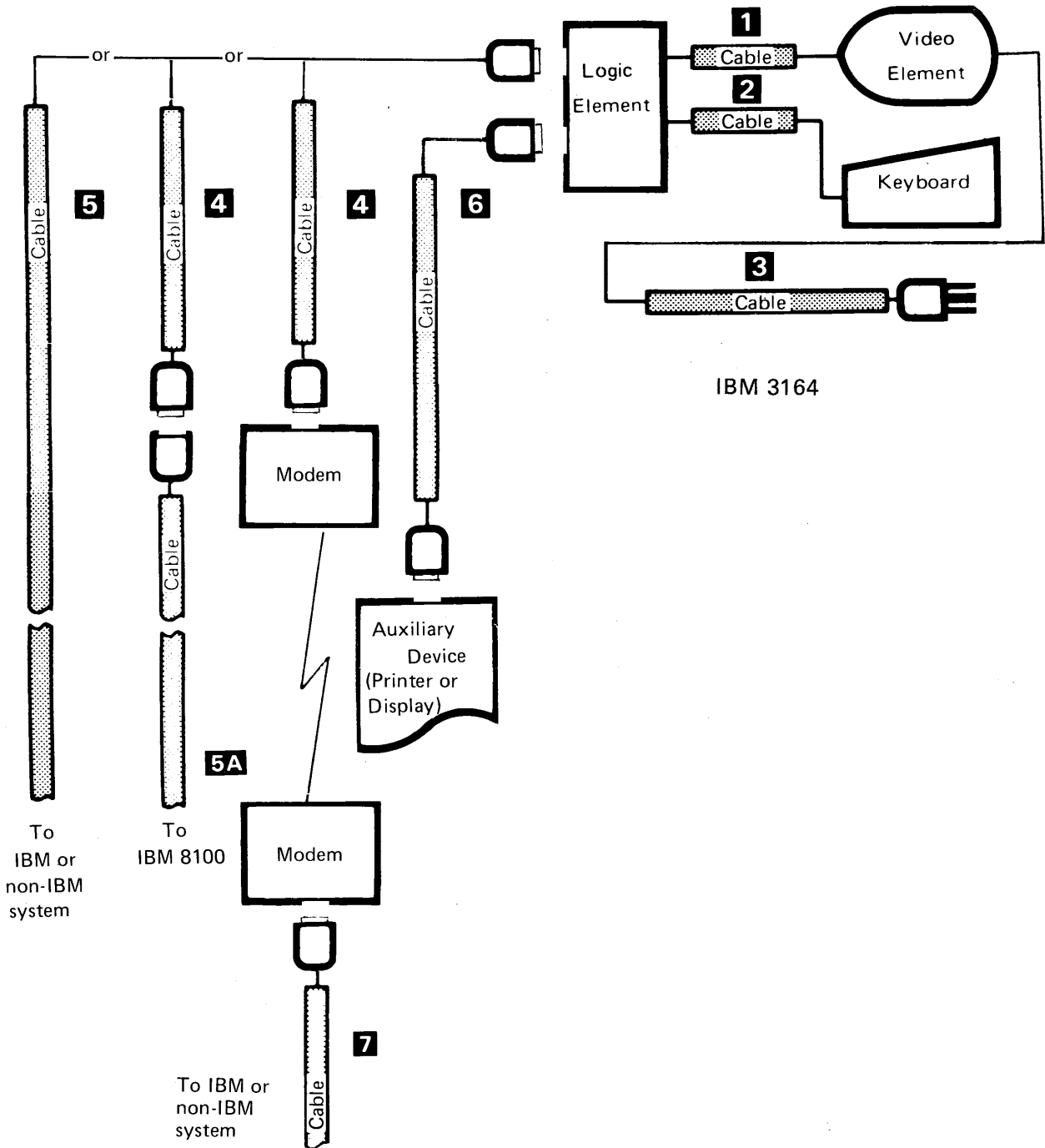

Callout	Name	From	To	Part No.	Cable Length	Description
1	Video Cable	Video Element	Logic Element	6405213	0.6 m (2 ft)	Used to connect the two elements. Provided with the IBM 3164.
2	Keyboard Cable	Keyboard	Logic Element	—	—	Used to connect the two elements. Provided with the IBM 3164.
3	Power Cord	Video Element	Power Outlet	6952297	2.8 m (9 ft)	Used for access to a power source. Provided with the IBM 3164.
				6952298	1.8 m (6 ft)	Supplied as an accessory for U.S. only.
4	Modem Cable	Modem or Cable 5A	Logic Element	6343332	3 m (10 ft)	For an EIA RS-232C or a CCITT V.24/V.28 interface. Supplied as an accessory.
5	Communication Cable	Host	Logic Element	Various (See note 1)	Variable	For an EIA RS-422A or a CCITT V.11 interface. The shielded twisted-pair cable must be used.
				8310553	2.4 m (8 ft)	For an EIA RS-422A or a CCITT V.11 interface via the IBM Cabling System. Supplied as an accessory.
				Various (See note 2)	Variable	For an EIA RS-232C or a CCITT V.24/V.28 interface. The shielded cable must be used.
5A	Communication Cable	IBM 8100	Cable 4	4946680	Variable	For direct attachment to the IBM 8100 System using an EIA RS-232C or a CCITT V.24/V.28 interface. Supplied with the host system.
6	I/O Cable	Logic Element	Auxiliary Device	Depends on the auxiliary device.	Variable	For an EIA RS-232C or a CCITT V.24/V.28 interface.
		Logic Element	IBM 4201 Proprinter	6343373	1.5 m (5 ft)	For an RS-232C or a CCITT V.24/V.28 interface. Supplied as an accessory.
7	Modem Cable	Host	Modem	Various	Variable	For an EIA RS-232C or a CCITT V.24/V.28 interface.

Notes:

1. For direct attachment to the IBM Series/1, refer to "IBM Site Preparation Manual", GA34-0050.
2. For direct attachment to the IBM Series/1, the cable supplied with the host system is part number 1632924.

Chapter 6. Physical installation

The IBM 3164 uses a 2.8-meter (9-foot), 3-wire, power cord that includes an equipment grounding wire (green, or green and yellow). The plug has a ground pin to be used with a corresponding receptacle.

Shown below is a drawing of the power plug.

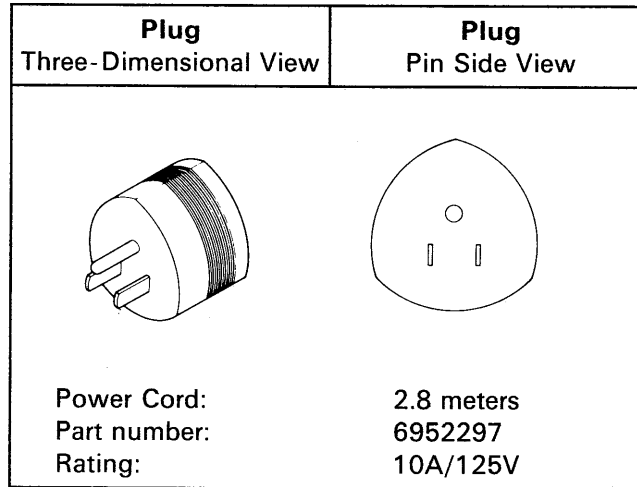

CAUTION

The power cord plug (when supplied) is approved for use with this display station and meets the relevant testing laboratory, country, or test-house standards. For your safety, the plug must be connected to a properly wired and grounded receptacle. An improperly wired receptacle could place a hazardous voltage on accessible metal parts of the display station. The customer is responsible for receptacle wiring.

Planning checklist

Do these sequence of steps before you install your display station(s).

Date	Event
	Identify the person who will be responsible for all phases of the planning and preparation.
	Review specifications for cables that may not be ordered from IBM, and gather procurement source information.
	Review electrical requirements stated in this chapter.
	Make a site preparation plan. Prepare a floor plan showing the location of the IBM 3164. Consider the lengths of cables and power cords.
	Order cables from a contractor, if needed.
	Arrange for the installation of cables, power receptacles, wiring, etc.
	Define an employee training program, if necessary.
	Start the site preparation work according to the plan previously prepared. Give a copy of the "Physical Planning Template" on page 6-14 to the person who is preparing the installation site.
	Complete the installation of cables, power receptacles, wiring, etc.
	Complete the site preparation.
	Make sure that the site preparation for the end connector of the modem or the host system and wiring have been completed.
	Fill out the "Setup Sheet" and "Select Sheet" in Appendixes A and B respectively, and give it to the person who is going to set up the display station.
	Fill out the "Keyboard Layout Sheet" in Appendix C, and give it to the person who is going to change the keyboard layout. Make sure you ordered the necessary accessories.

Chapter 6. Physical installation

Physical Planning Template

Use this sheet to plan a layout of your site prior to installing the display station(s).

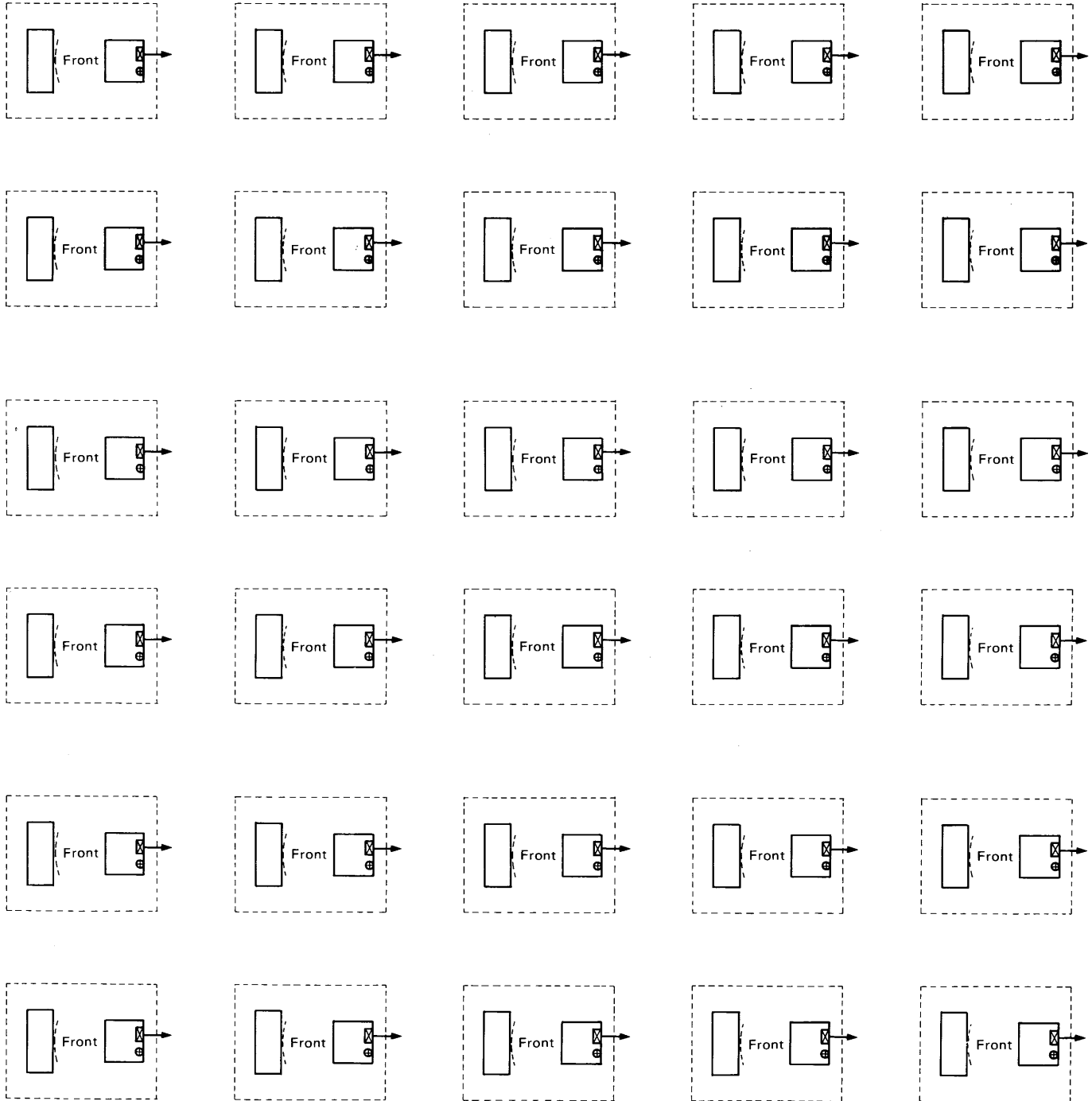

Scale: 2cm = 1 meter
☒ : Cable Exit Area
⊕ : Power Cord Exit

SETUP MENU		
Machine Mode	<input type="text"/>	
Operating Mode	<input type="text"/>	
	Main Port	Auxiliary Port
Interface	<input type="text"/>	
Line Control	<input type="text"/>	
Line Speed (bps)	<input type="text"/>	<input type="text"/>
Parity	<input type="text"/>	<input type="text"/>
Turnaround Character	<input type="text"/>	<input type="text"/>
Stop Bit	<input type="text"/>	<input type="text"/>
Word Length (bits)	<input type="text"/>	<input type="text"/>
Response Delay (ms)	<input type="text"/>	<input type="text"/>
Break Signal (ms)	<input type="text"/>	<input type="text"/>
Terminal ID:	<input type="text"/>	
	(Up to 20 alphanumeric characters are allowed.)	

Appendix B. Select Sheet

SELECT: ENTER= RETURN= NEW LINE= TAB= LINE WRAP=

AUTO LF= SEND= SEND NULL= INSERT= TRACE= CRT SAVER=

SCROLL= PRINT= PRINT NULL= PRINT EOL= LINE END=

To the supervisor

1. Photocopy this sheet before you fill it out. Make one copy for each IBM 3164 you will install.
2. Fill in the keys you are going to change (non-shaded keys).
3. Give each completed sheet to the person who will set up the display station.

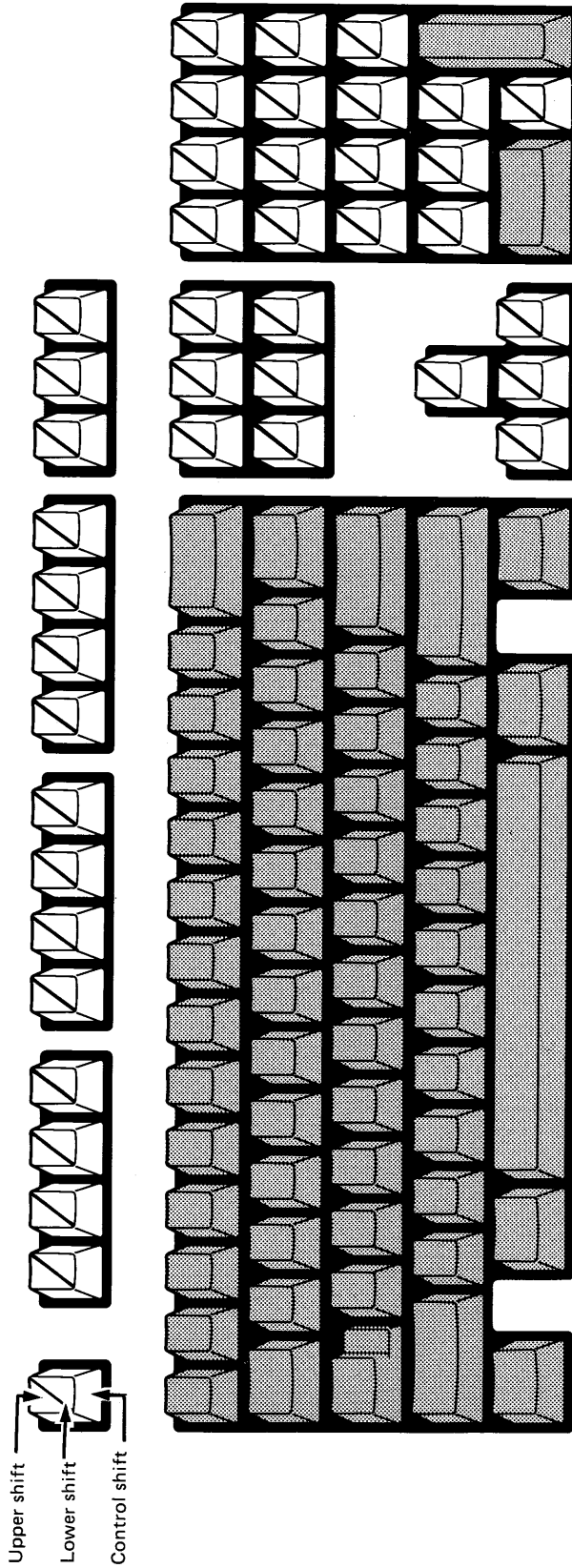

Appendix D. Modem and printer attachment instructions

This section tells you how to attach the various modems and printers to the IBM 3164. The IBM 4201 Proprinter is given as an example for a printer connection although any equivalent printer can be connected.

Modem cable connection

To communicate with the host system over the telephone network, you must first connect your terminal to the modem using a modem cable. The modem cable for the IBM 3164 varies, depending on the type of modem used. For each type of modem, an appropriate modem cable and a wrap socket, as shown below are available. You can order these items from IBM by specifying the part numbers.

The following is the test procedure to check whether the modem cable operates normally.

Step 1. Set the power switch to off (O), and disconnect the modem cable on the modem side.

Step 2. Connect the wrap socket (part number 5640724) to the modem cable (part number 6343332) on the modem side.

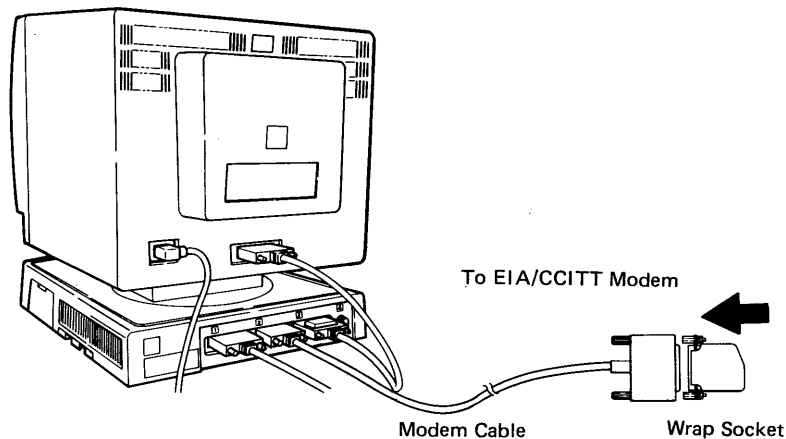

Step 4. Press and hold the **Ctrl** key, then press the **Setup** key to display the setup menu. Make sure the Test/Normal switch is set to Normal.

Step 5. Set the operating mode field to **CHAR** and the line control field to **CRTS**. (This means that the display station will be operating in character and half-duplex mode.)

Step 6. Press the **Send** key to store the new condition in your display station and exit setup mode.

Step 7. Press any alphanumeric key (for instance an **a**). The RTS wraps to CTS and DCD and the following screen is displayed if all signals are wrapped correctly.

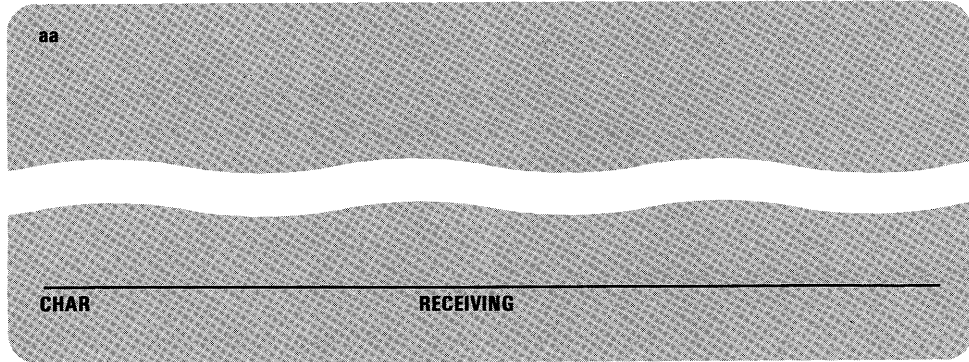

Note: If one of the following symptoms appear on your screen, it means the wrap test failed and there is a problem either in the logic element or the modem cable.

- COMM NOT READY 1 is displayed (RTS or CTS is off)
- COMM NOT READY 2 is displayed (either DTR or DSR is off)
- Only the first character is displayed (TXD or RXD is off)
- RECEIVING is not displayed (DCD is off).

Step 8. Remove the wrap socket and restore the display station to the normal operating condition. Then reset the values on the Setup menu to the original condition.

Shown below is the pin assignment for the EIA/CCITT modem cable.

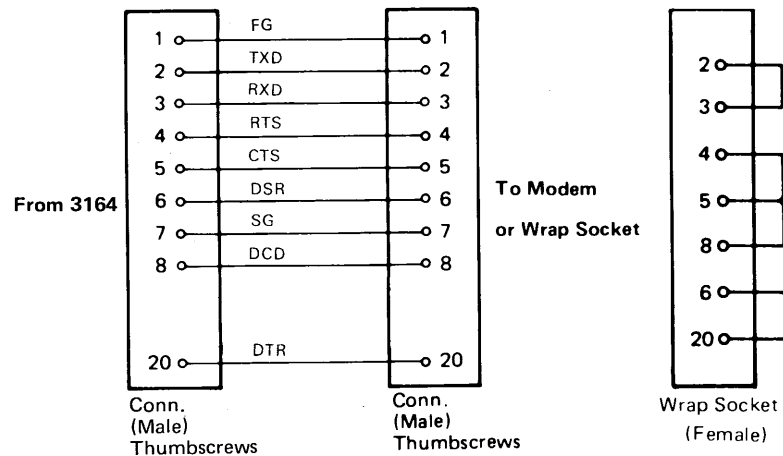

Note: For the meaning of the abbreviations, refer to the pin assignment in Chapter 6.

IBM 4201 Proprinter connection

If you have an IBM 4201 Proprinter with a serial interface, you can attach the printer to the auxiliary port of the IBM 3164 via the I/O cable (part number 6343373).

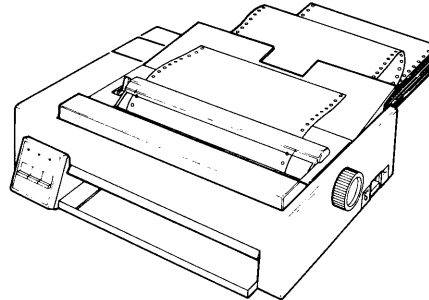

In Print operation, the ASCII characters (refer to page 5-79) are transferred to the printer while the special graphic characters and the alternate characters are converted into space characters.

The Passthrough operation of the IBM 3164 enables you to use the IBM 4201 Proprinter with its full functions such as the use of the 4201 character fonts and downloaded characters.

Note: In Trace operation, prints may not be formatted properly because of the difference in the command formats of the IBM 3164 and the IBM 4201 Proprinter.

As a precaution against a printer buffer overrun, one of the following is recommended:

1. Use of the XON/XOFF pacing function which is enabled by setting bit 1 in parameter 3 of the Set Control 6 command to on (1) (refer to page 5-20).
2. Use of the DTR pacing function which is enabled by setting bits 4 through 1 in parameter 3 of the Set Control 7 command to '0101' (refer to page 5-22).

Cable pin assignment

Shown below is the pin assignment for the I/O cable (part number 6343373).

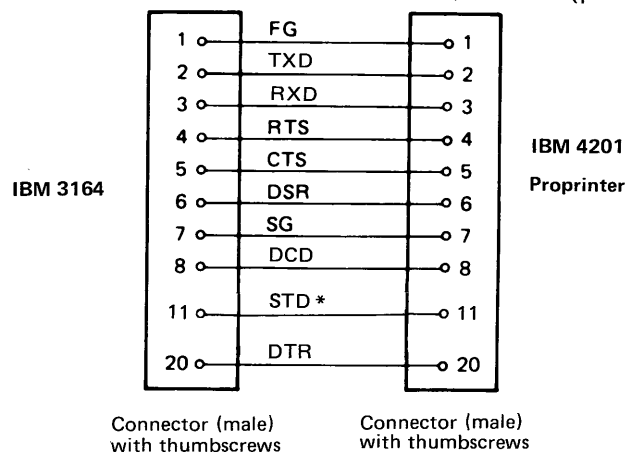

Note: Pin 11 STD is also called "Printer Status" in this publication.



Appendix E. Emulating the IBM 3101

This section assumes that you have used the IBM 3101 Model 23 terminal before, and have some operating knowledge of it. For more information on the IBM 3101 Model 23, refer to *IBM 3101 Display Terminal Description*, GA18-2033.

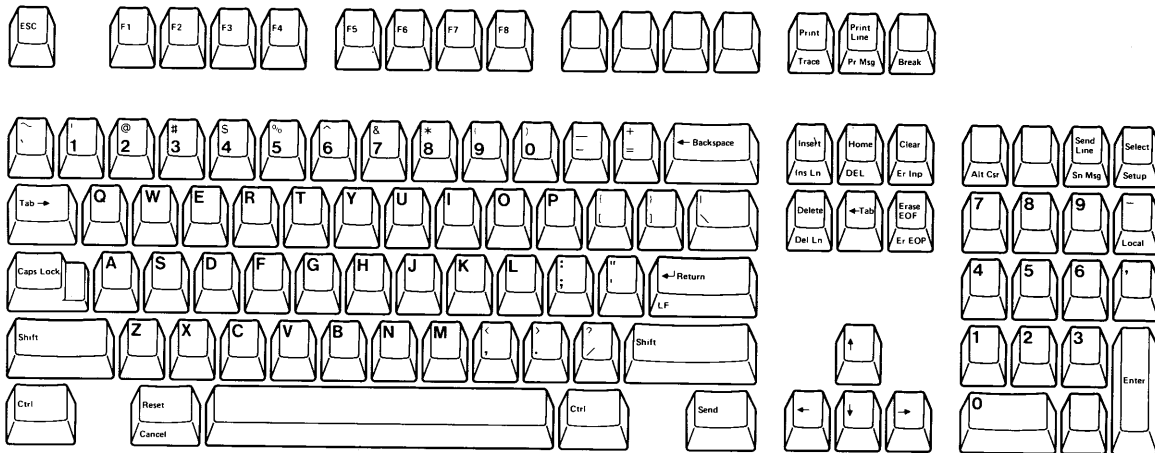
Emulating the IBM 3101 Model 23 keyboard



You can emulate the following IBM 3101 Model 23 key functions	by using the following IBM 3164 functions in emulation mode
ATTR key	Not applicable. But the field attribute can be written by using ESC 3 x from the keyboard
PRGM MODE key	Not applicable
ESC key	ESC key
PRINT MSG key	Pr Msg Key
PRINT LINE key	Print Line key
PRINT key	Print key

You can emulate the following IBM 3101 Model 23 key functions	by using the following IBM 3164 functions in emulation mode
ERASE EOL/EOF key	Erase EOF key
ERASE INPUT key	Er Inp key
ERASE EOS key	Er EOP key
CLEAR key	Clear key
SEND MSG key	Sn Msg key
SEND LINE key	Send Line key
 (Click) key	Not applicable
LOCAL key	Local Key
→ (Tab) key	Tab→ key
 (Shift Lock) key	Caps Lock key for alphabets only
⇧ (Shift) key	Shift key
RESET key	Reset key
CANCEL key	Cancel key
← (Backspace) key	← Backspace key
← (Back Tab) key	← Tab key
↵ (New Line) key	↵ Return key
ALT key	Ctrl key
SEND key	Send key
DEL key	DEL key
BREAK key	Break key
 (Home) key	Home key
INS CHAR key	Insert key
INS LINE key	Ins Ln key
DEL CHAR key	Delete key
ASCII graphic character keys	ASCII graphic character keys
↑ (Cursor Up) key	↑ key
↓ (Cursor Down) key	↓ key
← (Cursor Left) key	← key
→ (Cursor Right) key	→ key
PF1 - PF8 keys	F1 - F8 keys
0 - 9 (Numeric keypad) keys	0 - 9 (Numeric) keypad keys
DEL LINE key	Del Ln key
ASCII Control Character keys	Refer to page 3-5

Emulating the IBM 3101 Model 23 switches

Shown below is the setup menu for emulating the IBM 3101 Model 23 switches:

```

                S E T U P   M E N U
-----
Press Space to select alternatives.
Machine Mode  IBM 3101
Operating Mode BLOCK

                Main Port          Auxiliary Port
                -----          -----
Interface      RS-232C
Line Control   PRTS
Line Speed (bps) 9600
Parity         ODD
Turnaround Character ETX
Stop Bit       1                      1

When all finished, press Send.  Press Setup to quit.
-----
LOCAL

```

Shown below is the select menu for emulating the IBM 3101 Model 23. Unlike the IBM 3164 mode, the emulation mode has only one select menu.

```

-----
SCROLL=ON  RETURN=CR-LF  LINE WRAP=OFF  AUTO LF=OFF  SEND=PAGE  NULL SUPP=OFF

```

The table on the next page tells you how to emulate the 3101 Model 23 switches using the above menus.

You can emulate the following IBM 3101 Model 23 setup switch functions	by using the following IBM 3164 functions in emulation mode
BLOCK/CHAR switch (position 1 in group 1).	Setup menu (selectable from BLOCK, CHAR, and ECHO mode on the Operating Mode field).
HDX/FDX switch (position 2 in group 1).	Setup menu (automatically selected when the operating mode is selected).
Interface switch (position 3 in group 1).	Setup menu (selectable between RS-232C and RS-422A on the Interface field).
PRTS/CRTS switch (position 4 in group 1).	Setup menu (selectable from PRTS, CRTS, and IPRTS on the Line Control field).
REVERSE CH switch (position 5 in group 1).	This condition is not available.
Turnaround Character switches (positions 6 and 7 in group 1).	Setup menu (selectable from ETX, CR, EOT, and DC3 on the Turnaround Character field).
DUAL/MONO switch (position 8 in group 1).	This condition is not available.
Stop 1/Stop 2 switch (position 1 in group 2).	Setup menu (selectable between 1 and 2 on the Stop Bit field).
Parity Bit Selection switches (positions 2 and 3 in group 2).	Setup menu (selectable from ODD, NO, SPACE, MARK, and EVEN on the Parity field).
Send Line Option switch (position 4 in group 2).	Select menu (selectable between PAGE and LINE on the Send field).
NULL SUPP switch (position 6 in group 2).	Select menu (selectable between ON and OFF on the Null Supp field).
Time-Fill switches (positions 7 and 8 in group 2).	This condition is not available.
AUTO NL switch (position 1 in group 3).	Select menu (selectable between ON and OFF on the Line Wrap field).
AUTO LF switch (position 2 in group 3).	Select menu (selectable between ON and OFF on the Auto LF field).
CR/CR.LF switch (position 3 in group 3).	Select menu (selectable between CR-LF and CR on the Return field).
SCROLL switch (position 4 in group 3).	Select menu (selectable between ON and OFF on the Scroll field. SMOOTH can be selected but does not work on the IBM 3101.)
REVERSE VIDEO switch (position 7 in group 3).	This condition is not available.
Blink Cursor switch (position 8 in group 3).	This condition is available on the Alt Csr key.
Line speed switches for telecommunication interface (positions 1 to 4 in group 4).	Setup menu (selectable from 50, 75, 110, 134.5, 150, 200, 300, 600, 1200, 1800, 2400, 3600, 4800, 7200, 9600, and 19200 bps on the Line Speed field).
Line speed switches for auxiliary interface (positions 5 to 8 in group 4).	Setup menu (selectable from 50, 75, 110, 134.5, 150, 200, 300, 600, 1200, 1800, 2400, 3600, 4800, 7200, 9600, and 19200 bps on the Line Speed field).

Emulating the IBM 3101 Model 23 Commands

Command name	You can emulate the following IBM 3101 Model 23 commands	by using the following IBM 3164 functions in emulation mode
Set Tab	ESC 0	ESC 0
Clear Tab	ESC 1	ESC 1
Back Tab	ESC 2	ESC 2
Start Field	ESC 3 Pa*	ESC 3 Pa
Read Cursor Address	ESC 5 ESC 5 Pr Pc (response)	ESC 5 ESC 5 Pr Pc (response)
Read Status	<p>ESC 6 ESC 6 Pa1 Pa2 (response)</p> <p>Pa1 bit 7: Inverse of bit 6 6: Communication buffer overrun 5: Line parity error detected 4: Command error detected 3: (Reserved) 2: Keyboard locked 1: Printer busy</p> <p>Pa2 bit 7: Inverse of bit 6 6: Block mode 5: HDX operation 4: (Reserved) 3: (Reserved) 2: Program Mode 1: Local mode</p>	<p>ESC 6 ESC 6 Pa1 Pa2 (response)</p> <p>Pa1 bit 7: Inverse of bit 6 6: Communication buffer overrun 5: Line parity error detected 4: Command error detected 3: (Reserved) 2: Keyboard locked 1: Printer busy</p> <p>Pa2 bit 7: Inverse of bit 6 6: Operating mode 0 0 Echo mode 5: Operating mode 0 1 Character mode 1 0 Block mode 1 1 (Reserved)</p> <p>4: (Reserved) 3: (Reserved) 2: Always 0 1: Local mode</p>
Read Setup Switch	<p>ESC 7 ESC 7 Pa1 Pa2 (response)</p> <p>Pa1 bit 7: Inverse of bit 6 6: Block mode 5: HDX operation 4: PRTS 3: Reverse channel 2: Turnaround character 1: Turnaround character</p> <p>Pa2 bit 7: Inverse of bit 6 6: Dual case 5: Null suppression 4: Automatic new-line 3: Automatic line-feed 2: CR/CR.LF 1: Scrolling</p>	<p>ESC 7 ESC 7 Pa1 Pa2 (response)</p> <p>Pa1 bit 7: Inverse of bit 6 6: Operating mode 0 0 Echo mode 5: Operating mode 0 1 Character mode 1 0 Block mode 1 1 (Reserved)</p> <p>4: PRTS 3: Always 0 2: Turnaround character 1: Turnaround character</p> <p>Pa2 bit 7: Always 0 6: Always 1 5: Null suppression 4: Automatic new-line 3: Automatic line-feed 2: CR/CR.LF 1: Scrolling</p>
Read Buffer	ESC 8	ESC 8
Set Control	<p>ESC 9 Pa</p> <p>Bit 7: Inverse of bit 6 6: Specified data to be sent 0 0 All data 5: Specified data to be sent 0 1 Unprotected 1 0 Unprotected 1 1 Modified</p> <p>4: Prohibit from entering local mode 3: Prohibit from entering operator initiated transparent mode 2: Prohibit from entering program mode 1: Disable print keys</p>	<p>ESC 9 Pa</p> <p>Bit 7: Inverse of bit 6 6: Specified data to be sent 0 0 All data 5: Specified data to be sent 0 1 Unprotected 1 0 Unprotected 1 1 Modified</p> <p>4: Prohibit from entering local mode 3: Prohibit from entering operator initiated transparent mode 2: (Reserved) 1: Disable print keys</p>

Command	You can emulate the following IBM 3101 Model 23 commands	by using the following IBM 3164 functions in emulation mode
Set Control 1	Not applicable	ESC space 9 Pa Bit 7: Always 1 6: Always 0 5: (Reserved) 4: Machine mode 0 0 IBM 3164 mode 3: Machine mode 0 1 IBM 3101 mode 1 0 (Reserved) 1 1 (Reserved) 2: Operating mode 0 0 Echo mode 1: Operating mode 0 1 Character mode 1 0 Block mode 1 1 (Reserved)
Cursor Up Cursor Down Cursor Right Cursor Left	ESC A ESC B ESC C ESC D	ESC A ESC B ESC C ESC D
Write Send Mark	ESC E	ESC E
Cursor Home	ESC H	ESC H
Erase EOF/EOL Erase EOS Erase Input Clear All	ESC I ESC J ESC K ESC L	ESC I ESC J ESC K ESC L
Insert Line Delete Line Insert Character Delete Character	ESC N ESC O ESC P ESC Q	ESC N ESC O ESC P ESC Q
Print Line Print Message Print Page	ESC U ESC V ESC W	ESC U ESC V ESC W
Set Buffer Address Set Cursor Address Insert Cursor	ESC X Pr Pc ESC Y Pr Pc ESC Z	ESC X Pr Pc ESC Y Pr Pc ESC Z
Lock Keyboard Unlock Keyboard	ESC ; ESC ;	ESC ; ESC ;

Note: The color of the screen is the same as that of the Default Color Mode.





Appendix F. Information for the Americas and the Far East

Power requirements

Requirements	Voltage	
	Low	High
KVA (Maximum)	0.28	0.28
Wattage	100	100
Phase	1	1
Amperage	2.3	1.2
Voltage (Vac)	90-127	200-240
Power Cord	2.8 m (9 ft)	2.8 m (9 ft)
	3-wire, with green and yellow grounding wire	
Plug Type	See "Power Plug Types"	

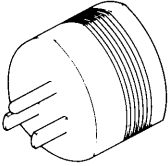
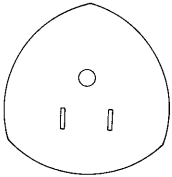
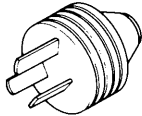
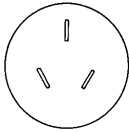
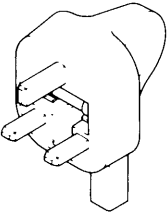
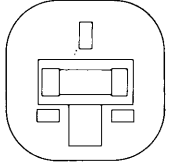
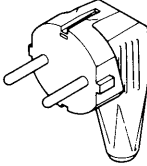
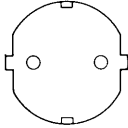
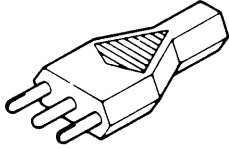
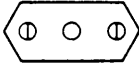
Power plug types

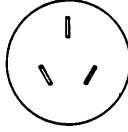
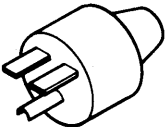
Country	Voltage		Country	Voltage	
	125V	250V		125V	250V
Argentina		F	Malaysia		C
Australia		B	Mexico	A	
Bolivia	A		New Zealand		B
Canada	A		Panama	A	
Chile		E	Paraguay		F
Columbia	A		Philippines	A	
Costa Rica	A		Singapore		C
Dominican Republic	A		Taiwan	A	
Ecuador	A		Uruguay		F
El Salvador	A		Venezuela		G
Guatemala	A				
Honduras	A				
Hong Kong		C			
Indonesia		D			
Japan	A				

Plug Three-Dimensional View		Plug Pin Side View		Plug Three-Dimensional View		Plug Pin Side View			
(A)			(B)			Power Cord	Part number: 6952297 Rating: 10A/125V	Power Cord	Part number: 6952308 Rating: 6A/250V
(C)			(D)			Power Cord	Part number: 6952353 Rating: 6A/250V	Power Cord	Part number: 6952317 Rating: 6A/250V
(E)			(F)			Power Cord	Part number: 6952371 Rating: 6A/250V	Power Cord	Part number: 6952285 Rating: 6A/250V
(G)						Power Cord	Part number: 6952397 Rating: 6A/250V		

Keyboard and keys (Canadian French)

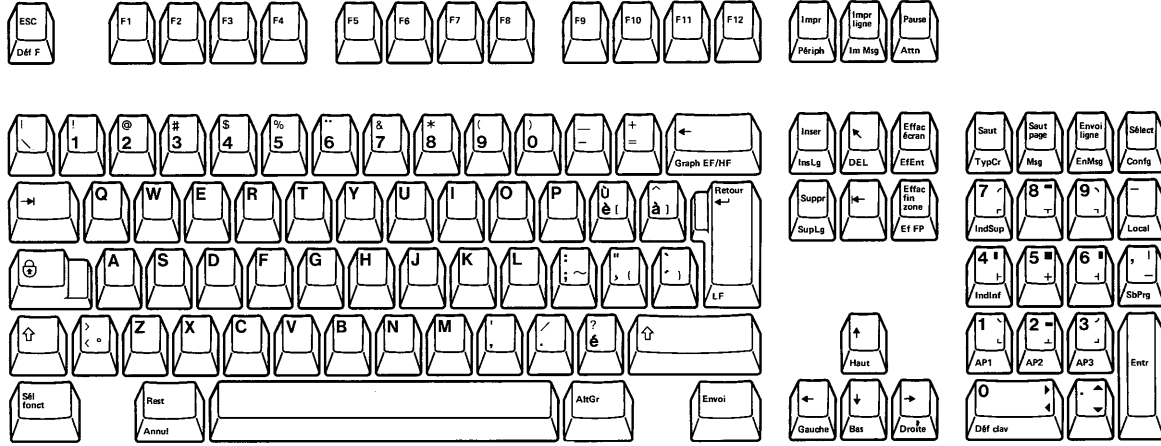

Dead keys

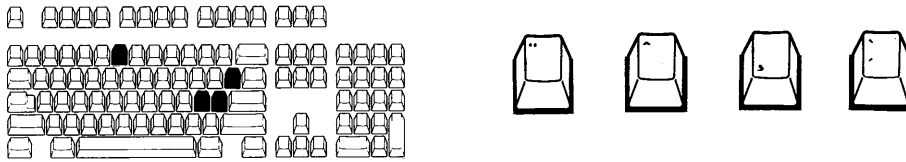

Used to type in characters with accent marks

This key is used to affix an accent mark (diaeresis, circumflex, cedilla, grave, and acute) on a character to form one composite character. If this key is pressed, the relevant accent mark appears. The character that is to receive the accent must be entered next. If the character is valid, a unique composite character called a diacritic character is formed. If the second character is invalid, INVALID KEY appears in the operator information area accompanied by an audible alarm. The accent mark is entered as an independent character if the second key is a spacebar. INVALID KEY remains displayed on the screen and the cursor does not move until a valid character to the accent is keyed-in, releasing the dead key sequence mode. Reset key can also release this mode.

AltGr (Alternate Graphic) key

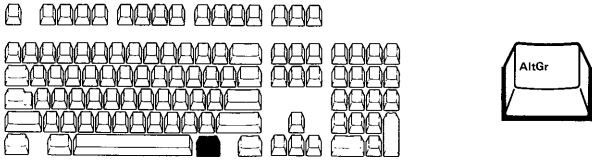

Puts the keyboard in Alternate Graphic shift (AltGr)

When you press this key, the display station enters the Alternate Graphic state which then enables you to type in the characters indicated on the bottom right of some keytops. The keys having the additional functions are shown below (without shading):

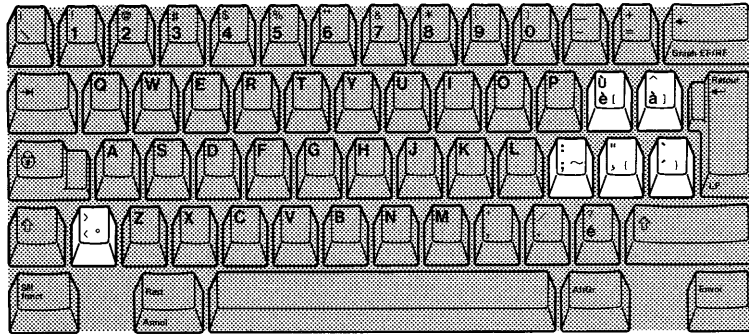

AltGr appears in the operator information area each time you press this key, and disappears when you release it.

Various menus (Canadian French)

Operator Messages

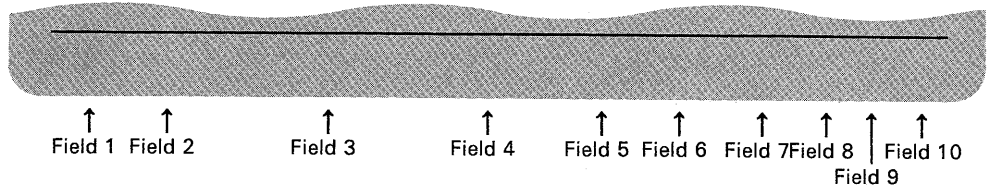

Normal mode

Field	Message
1	ECHO
	CAR
	BLOCS
	LOCAL
	TEST
2	TRANSP
3	COMM. IMPOSSIBLE 1
	COMM. IMPOSSIBLE 2
	U. AUX. PAS PRETE
	HOTE OCCUPE
	U. AUX. OCCUPEE
	PAUSE
	ENVOI
	RECEPTION
	IMPRESSION
	CLAV. VERROUILLE
	TOUCHE INCORRECTE
	POS. INCORRECTE

Field	Message
3	ERREUR CLAVIER
	NUMERIQUE
	ENTREE OBLIGAT.
	REMP LIS. OBLIGAT.
	ERREUR PROG. HOTE
4	INSER.
5	Syn
6	INDICE SUP.
	INDICE INF.
	SEL. FONCT.
	AltGr
	MAJUSCULES
	VERR. MAJ.
	PAS DE CLAV.
7	GRA
8	PERI
9	P.m
10	(xxx,yyy)

Machine check

Field	Message
3	INCIDENT UNITE LOGIQUE VOIR GUIDE DE L'UTILISATEUR
	INCIDENT UNITE LOGIQUE OU CLAVIER VOIR GUIDE DE L'UTILISATEUR
	INCIDENT CLAVIER VOIR GUIDE DE L'UTILISATEUR

Setup Menu (Canadian French)

CONFIGURATION

Appuyez sur la barre d'espacement pour choisir d'autres valeurs.

Mode machine: **IBM 3164**

Mode d'utilisation: **BLOCS**

	Porte principale	Porte auxiliaire
Interface:	RS-232C	
Contrôl de ligne:	PRTS	
Vitesse de ligne:	9600	9600
Parité:	IMPAIRE	IMPAIRE
Caractère de retournement:	ETX	
Bit d'arrêt:	1	1
Longueur de mot (bits):	7	7
Temps de réponse (ms):	100	
Signal d'interruption (ms):	500	

ID du terminal: _____ (20 caractères au maximum)

Appuyez ensuite sur "Envoi" pour valider ("Config" = Quitter ce menu).

LOCAL

If you specify this field	and select this option
Mode machine	IBM 3164*
	IBM 3101
Mode d'utilisation	ECHO
	CAR
	BLOCS*
Interface	RS-232C*
	RS-422A
Contrôl de ligne	PRTS*
	CRTS
	IPRTS
Vitesse de ligne (bps)	50
	75
	110
	134.5
	150
	200

If you specify this field	and select this option
	300
	600
	1200
	1800
	2400
	3600
	4800
	7200
	9600*
	19200
Parité	IMPAIRE*
	PAIRE
	ESPACE
	REPERE
	NON

If you specify this field	and select this option
Caractère de retournement	ETX*
	EOT
	DC3
	CR
Bit d'arrêt	1*
	2
Longueur de mot (bits)	7*
	8
Temps de réponse (ms)	0
	100*
Signal d'interruption (ms)	170
	500*

Note: An asterisk (*) indicates the default value.

Select Menus (Canadian French)

SELECT: ENTREE=RETOUR RETOUR=CHAMP L.SUIV=CR TAB=CHAMP RET.MARGE AUTO=EF

LF AUTO=EF ENVOI=PAGE ENVOI NUL=EF INSER.=MODE PERIPH=TOUT PRO.TUBE=NON

DEFIL.=SAUT IMPR.=FENETRE INPR.NUL=EF INPR.FIN LIGNE=EF FIN LIGNE=CR-LF

If you specify this field	and select this option
ENTREE	RETOUR*
	ENVOI
RETOUR	CHAMP*
	L.SUIV
L.SUIV	CR*
	CR-LF
TAB	CHAMP*
	COL
RET.MARGE AUTO	EF*
	HF

If you specify this field	and select this option
LF AUTO	EF*
	HF
ENVOI	PAGE*
	LIGNE
ENVOI NUL	EF*
	HF
INSER	MODE*
	ESPACE
PERIPH	TOUT*
	RECEPT.
	ENVOI
PRO.TUBE	NON*
	5
	10
	15

If you specify this field	and select this option
DEFIL	SAUT*
	REGULIER
	HF
IMPR.	PAGE*
	ECRAN
	FENETRE
IMPR.NUL	EF*
	HF
IMPR.FIN LIGNE	EF*
	HF
FIN LIGNE	CR-LF*
	CR

Note: An asterisk (*) indicates a default setting.

Change Key Menus (Canadian French)

DEF.CLAV: Tapez No touche puis "Envoi". 1.INTER 2.COPIE 3.SUPPR. 4.DEFAUT 5.VERIF.

INTERVERSION: Entrez 2 "ID touche" puis appuyez sur "Envoi": et

COPIE: Entrez 2 "ID touche" puis appuyez sur "Envoi": de à

SUPPRESSION: Entrez "ID touche" puis appuyez sur "Envoi".

DEFAUT: Appuyez sur "Envoi" pour réinitialiser les touches.

VERIFICATION: Tapez la touche à vérifier. M: C: S:

Define Function Menu (Canadian French)

Déf F: Attn

Select Menu for IBM 3101 Emulation (Canadian French)

DEFIL=SAUT RETOUR=CR-LF RET.MARGE AUTO=EF LF AUTO=EF ENVOI=PAGE SUPP.NULL=EF

If you specify this field	and select this option
DEFIL	SAUT*
	HF
RETOUR	CR-LF*
	CR
RET.MARGE	EF* AUTO
	HF
LF AUTO	EF*
	HF
ENVOI	PAGE*
	LIGNE
SUPP.NUL	EF*
	HF

Note: An asterisk (*) indicates a default setting.

Selecting the character set (Canadian French)

The Select Character Set command is used for selecting two character sets out of four. The format for selecting this command is given below.

ESC < Pa
ESC > Pa

Parameter:

@: Character Set 1 (ASCII)
A: Special Graphics
B: Character Set 2
C: Alternate Character

For details on this command, refer to Chapter 5.

After a power-on-reset (POR) sequence, the G0 space is selected for Character Set 1 and G1 space for Character Set 2.

The method of selecting the two active spaces G0 and G1 depends on the Word Length option you are presently using; the 7-bit or the 8-bit word length. The figures on the following two pages illustrate how this works for the inbound and outbound operations.

7-bit Mode Operation

The figure below shows the character set selection for the outbound operation.

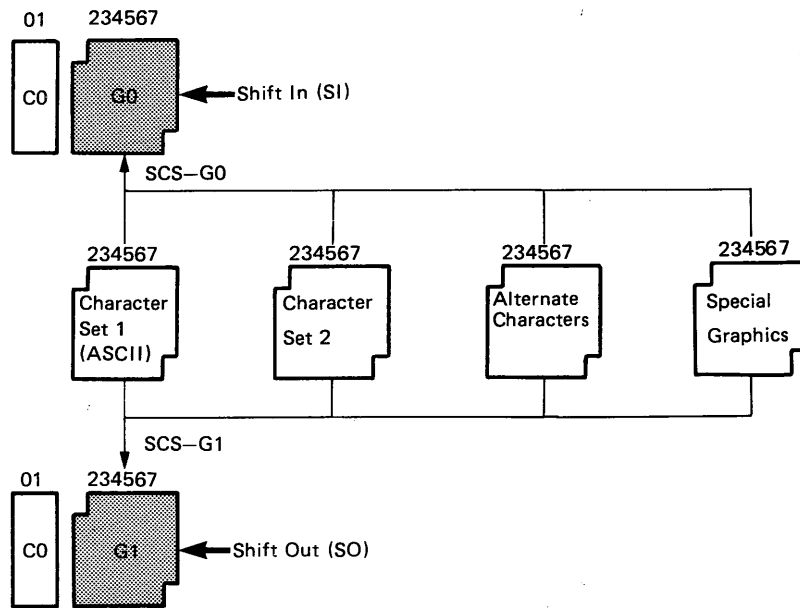

The figure below shows the character set selection for the inbound/keyboard operation.

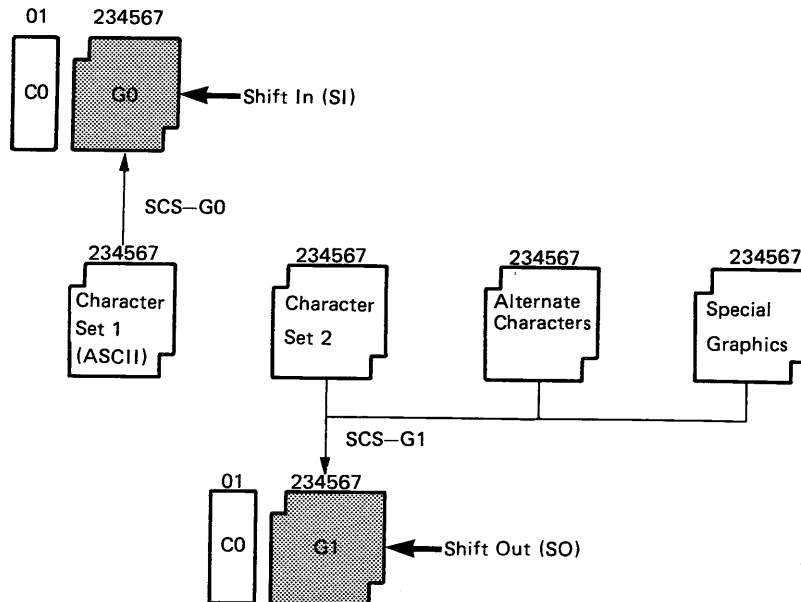

8-bit Mode Operation

The figure below shows the character set selection for the outbound operation.

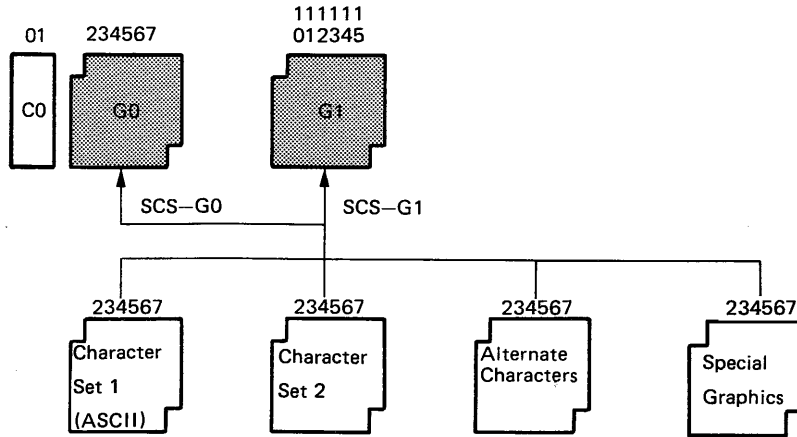

The figure below shows the character set selection for the inbound/keyboard operation.

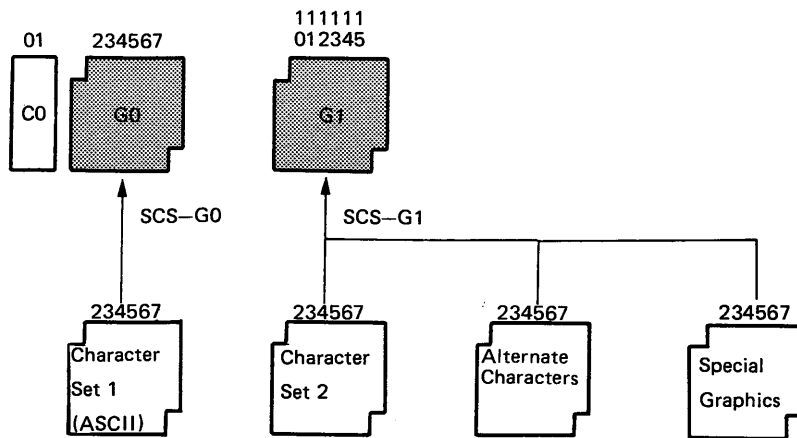

Character set 1 (ASCII Table)

Bits				b7	0	0	0	0	1	1	1	1
				b6	0	0	1	1	0	0	1	1
				b5	0	1	0	1	0	1	0	1
b4	b3	b2	b1	Hex 0	0	1	2	3	4	5	6	7
				Hex 1								
0	0	0	0	0	NUL	DLE	SP	0	@	P	`	p
0	0	0	1	1	SOH	DC1	!	1	A	Q	a	q
0	0	1	0	2	STX	DC2	"	2	B	R	b	r
0	0	1	1	3	ETX	DC3	#	3	C	S	c	s
0	1	0	0	4	EOT	DC4	\$	4	D	T	d	t
0	1	0	1	5	ENQ	NAK	%	5	E	U	e	u
0	1	1	0	6	ACK	SYN	&	6	F	V	f	v
0	1	1	1	7	BEL	ETB	'	7	G	W	g	w
1	0	0	0	8	BS	CAN	(8	H	X	h	x
1	0	0	1	9	HT	EM)	9	I	Y	i	y
1	0	1	0	A	LF	SUB	*	:	J	Z	j	z
1	0	1	1	B	VT	ESC	+	;	K	[k	{
1	1	0	0	C	FF	FS	,	<	L	\	l	
1	1	0	1	D	CR	GS	-	=	M]	m	}
1	1	1	0	E	SO	RS	.	>	N	^	n	~
1	1	1	1	F	SI	US	/	?	O	_	o	DEL

Character set 2

Bits				b7	0	0	0	0	1	1	1	1
				b6	0	0	1	1	0	0	1	1
				b5	0	1	0	1	0	1	0	1
b4	b3	b2	b1	Hex 0	0	1	2	3	4	5	6	7
				Hex 1								
0	0	0	0	0				°	À		à	
0	0	0	1	1								
0	0	1	0	2					Â		â	
0	0	1	1	3								
0	1	0	0	4						Ô		ô
0	1	0	1	5								
0	1	1	0	6								
0	1	1	1	7					Ç		ç	
1	0	0	0	8				,	È		è	
1	0	0	1	9					É	Ù	é	ù
1	0	1	0	A					Ê		ê	
1	0	1	1	B					Ë	Û	ë	û
1	1	0	0	C						Ü		ü
1	1	0	1	D								
1	1	1	0	E					Ï		ï	
1	1	1	1	F					İ		ı	

Appendix G. Information for Europe, the Middle East, and Africa

Power requirements

Requirements	Countries
	France Germany Italy Netherlands Portugal South Africa United Kingdom
KVA (Maximum)	0.28
Wattage	100
Phase	1
Frequency (Hz)	50
Amperage	1.2
Voltage (Vac)	200 - 240
Power Cord	2.8 m (9 ft)
	3-wire, with green and yellow grounding wire
Plug Type	See "Power Plug Types"

Power plug types

Country	Voltage Range		Country	Voltage Range	
	125V	250V		125V	250V
France		A	Portugal		A
Germany		A	South Africa		D
Italy		C	United Kingdom		B
Netherlands		A			

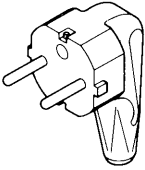
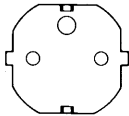
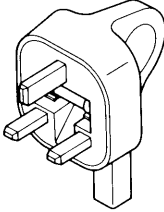
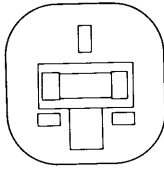
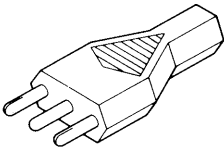
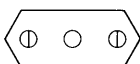
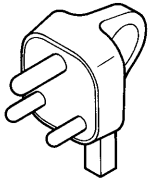
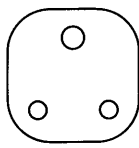
Plug Three-Dimensional View	Plug Pin Side View	Plug Three-Dimensional View	Plug Pin Side View
<p>(A)</p>  <p>Power Cord: Rating:</p>	 <p>P/N 6952317 6A/250V</p>	<p>(B)</p>  <p>Power Cord: Rating:</p>	 <p>P/N 6952353 6A/250V</p>
<p>(C)</p>  <p>Power Cord: Rating:</p>	 <p>P/N 6952371 6A/250V</p>	<p>(D)</p>  <p>Power Cord: Rating:</p>	 <p>P/N 6952344 6A/250V</p>

List of abbreviations

A

- ACK.** Acknowledge character.
- AID.** Attention identifier.
- ASCII.** American National Standard Code for Information Interchange.
- Aux.** Auxiliary interface.

B

- BA.** Buffer address.
- BEL.** Bell character.
- BS.** Backspace character.

C

- C.** Centigrade.
- CA.** Cursor address; character attribute.
- CAN.** Cancel character.
- CCA.** Current cursor address.
- CR.** Carriage return character.
- CRTS.** Controlled request-to-send.
- CTS.** Clear-to-send.

D

- DC2.** Device-control-2 character.
- DC4.** Device-control-4 character.
- DCD.** Data carrier detect.
- DEL.** Delete character.

DHDW. Set-double-height-double-width command/response.

DHSW. Set-double-height-single-width command/response.

DLE. Data-link-escape character.

DSR. Data-set-ready.

DTR. Data-terminal-ready.

E

EIA. Electronic Industries Association.

EM. End-of-medium character.

ENQ. Enquiry character.

EOF. End-of-field.

EOL. End-of-line.

EOL/F. End-of-line/end-of-field.

EOP. End-of-page.

EOS. End-of-screen.

EOT. End-of-transmission character.

ESC. Escape character.

ETB. End-of-transmission-block character.

ETX. End-of-text character.

F

F. Fahrenheit.

FA. Field attribute.

FF. The form-feed character.

FS. The file-separator character.

ft. Foot (feet).

G

GID. Page identifier.

GS. Group-separator character.

H

HT. Horizontal-tabulation character.

I

IC. Insert-cursor command.

in. Inch.

IPRTS. Induced permanent request-to-send.

ISO. International Organization for Standardization.

K

KBD. Keyboard.

kg. Kilogram.

KVA. Kilo-volt-ampere.

L

lb. Pound.

LE. Line end character(s).

LF. Line-feed character.

LRC. Longitudinal redundancy check.

LTA. Line turnaround character.

M

m. Meter.

mA. Milliampere.

MDT. Modified data tag.

mm. Millimeter.

ms. Millisecond.

MBS. Most significant bit.

msec. Millisecond.

N

NAK. Negative-acknowledge character.

NL. New-line character.

NUL. Null character.

NVM. Nonvolatile memory.

P

PID. Partition identifier.

P/N. Part number.

POR. Power-on-reset.

PRTS. Permanent request-to-send.

R

RIS. Reset to initial state.

RS. Record separator character.

RTS. Request to send

S

- SBA.** Set-buffer-address command/response.
- SCA.** Set-cursor-address command/response.
- SCS.** Select-character-set G0/G1 command/response.
- SFA.** Set-field-attribute command/response.
- SHDW.** Set-single-height-double-width command response.
- SHSW.** Set-single-height-single-width command response.
- SI.** Shift-in character.
- SO.** Shift-out character.
- SOH.** Start-of-header character.
- STX.** Start-of-text character.

- SUB.** Substitution character.
- SYN.** Synchronous character.

V

- VID.** Viewport identification.
- VT.** Vertical tabulation character.

X

- XOFF.** Transmission off.
- XON.** Transmission on.
- XSBA.** Extended-set-buffer-address command/response.
- XSCA.** Extended-set-cursor-address command/response.

This glossary defines terms and abbreviations that are used in this manual. If you do not find the term you are looking for, refer to the Index or to the *IBM Vocabulary for Data Processing, Telecommunications, and Office Systems*, GC20-1699.

Definitions from American National Standard Institute (ANSI) are identified with an asterisk. An asterisk between a term and the beginning of a definition indicates that the entire definition is taken from American National Dictionary for Information Processing.

The symbol "(ISO)" at the beginning of a definition indicates that it was developed by the International Standard Organization, Technical Committee 97, Subcommittee 1. Definitions from early working papers of ISO are identified by the symbol "(SCI)."

A

ASCII. American National Standard Code for Information Interchange. The standard code, using a coded character set consisting of 7/8-bit coded characters, used for information interchange among data processing systems, data communication systems, and associated equipment. The ASCII set consists of control characters and graphic characters.

attribute character. A code that defines the display attributes of the display field that follows. An attribute character is the first character in a display field, but it is not a displayable character.

audible alarm. An alarm that is activated when predetermined events occur that require operator attention or intervention for system operation.

B

block. (1) A string of records, a string of words, or a character string formed for technical or logic reasons to be treated as an entity. (2) A set of things, such as words, characters, or digits, handled as a unit.

block transfer. The process, initiated by a single action, of transferring one or more blocks of data.

buffer. An area of storage that is temporarily reserved for use in performing an input/output operation, into which data is read, or from which data is written. Synonymous with I/O area.

buffer address. The address of a location in the buffer at which one character can be stored.

buffer-print operation. An operation that prints the contents of the buffer from the IBM 3164 to an attached printer.

C

cathode ray tube (CRT). A vacuum tube display in which a beam of electrons can be controlled to form alphanumeric characters or symbols on a luminescent screen, for example, by use of a dot matrix.

character. (1) A member of a set of elements upon which agreement has been reached and that is used for the organization, control, or representation of data. Characters may be letters, digits, punctuation marks, or other symbols often represented in the form of a spatial arrangement of adjacent or connected strokes, or in the form of other physical conditions, in data media. (2) A letter, digit, or other symbol that is used as part of the organization, control, or representation of data.

character mode. An operating mode of the IBM 3164 in which data is transferred character by character in either half-duplex or duplex.

character position. Synonym for display position.

communication controller. A type of communication control unit whose operations are controlled by one or more programs stored and executed in the unit; for example, the IBM 3704/3705 and the 3725/3726 Communication Controllers.

control character. A character whose occurrence in a particular context initiates, modifies, or stops a control operation. A control character may be recorded for use in a subsequent action, and it may have a graphic representation in some circumstances.

controlled-request-to send (CRTS). A line control used on a half-duplex or duplex facility for an alternate one-way data transmission. When a terminal begins the data transmission to a host system, it turns on the request-to-send (RTS) signal which stays on until the terminal transmits a turnaround character.

cursor. In computer graphics, a movable marker that is used to indicate a position on a display space.

D

data stream. For the IBM 3164, all data transferred to the 3164 or printer through a telecommunication or auxiliary interface in a single read, write, or buffer-print operation.

direct connection. The attachment of a terminal or similar device directly to a host computer; that is, not through an interface, such as a modem.

display attribute. In computer graphics, a particular property that is assigned to all or part of a display; for example, underline, green color, blinking status.

display field. In computer graphics, an area in a display buffer or on a display space that contains a set of characters that can be manipulated or operated upon as a unit.

display position. In computer graphics, any position in a display space that can be occupied by a picture element or a display element.

display-station element. A functional element to which the user can isolate a fault and replace for maintenance purposes.

duplex. In data communication, pertaining to a simultaneous two-way independent transmission in both directions. Contrast with half-duplex.

E

escape command sequence. A two-character sequence that consists of ESC (hexadecimal code 1B in ASCII) and the command character that follows; specifies the IBM 3164 command.

F

field. (1) In a record, a specified area used for a particular category of data, for example, a group of card columns in which a wage rate is recorded. (2) In a data base, the smallest unit of data that can be referred to. (3) See display field.

formatted display. On a display device, a display in which the attributes of one or more display fields have

been defined by the user. Contrast with unformatted display.

Function (F) key. On a display device keyboard, a key that passes a signal to a program to call for a particular display operation.

G

graphic character. A character, other than a control character, that is normally represented by a graphic.

H

half-duplex. In data communication, pertaining to an alternate, one way at a time, independent transmission. Contrast with duplex.

host computer. (1) In a network, a computer that primarily provides services such as computation, data base access, or special programs or programming languages. (2) The primary or controlling computer in a multiple computer installation.

I

induced permanent-request-to send (IPRTS). A line control used on a duplex facility primarily for direct connection to a host system. The request-to-send (RTS) signal goes on at power-on and stays on until the terminal is powered-off.

input field. In computer graphics, an unprotected field on a display surface in which data can be entered, modified, or erased.

inquiry. A request for information from storage, or a machine statement to initiate a search of library documents.

intensified display. An attribute of a display field that causes data in that field to be displayed in red instead of green in Default Color mode.

interface. A shared boundary. An interface might be a hardware component to link two devices, or it might be a portion of storage or registers accessed by two or more computer programs.

L

local mode. In a telecommunication system, the operation of a terminal without interaction with the host program.

M

modem(modulator-demodulator). A device that modulates and demodulates signals transmitted over telecommunication facilities.

modified data tag (MDT). A bit in the attribute character of a display field that, when set, causes that field to be transferred to the channel during a read-modified operation. The MDT may be set by a keyboard input to the field, or by program control. It may be reset by program control or by the erase input (Er Inp) key.

N

nonswitched line. A telecommunication line on which connections do not have to be established by dialing.

null character (NUL). A control character that is used to accomplish media-fill or time-fill, and that may be inserted into or removed from a sequence of characters without affecting the meaning of the sequence; however, the control of equipment or the format may be affected by this character.

null suppression. The by-passing of all null characters to reduce the amount of data to be transferred.

O

operator information area. For the IBM 3164, the 25th row of data on the display surface in which the operator is supplied information concerning system status.

P

parity check. (1) A redundancy check that uses a parity bit. (2) For the IBM 3164, occurs when 3164 circuitry detects one or more characters with bad parity in a buffer.

permanent-request-to send (PRTS). A line control used on a duplex facility for a simultaneous data transmission. The request-to-send (RTS) signal goes on at power-on and stays on until the terminal is powered-off.

protected field. On a display device, a display field in which the user cannot enter, modify, or erase data. Data in this field is displayed in blue instead of green in Default Color mode.

R

remote attachment. The attachment of a terminal or other similar device to a host computer by means of a data link; for example, a modem.

reverse video. A form of highlighting a character, field, or cursor by reversing the color of the character, field, or cursor with its background; for example, changing a green character on a black background to a black character on a green background.

S

scrolling. In computer graphics, moving, vertically or horizontally, a display image in a manner such that new data appears at one edge as old data disappears at the opposite edge.

start-stop transmission. Asynchronous transmission such that a group of signals representing a character is preceded by a start element and followed by a stop element.

switched line. A telecommunication line in which the connection is established by dialing. Contrast with nonswitched line.

T

telecommunication administration. Any governmental department or service responsible for implementing the obligations undertaken in the International Telecommunication Convention and the Regulations annexed thereto.

telecommunication facility. (1) Transmission capabilities, or the means for providing such capabilities, made available by a communication common carrier or by a telecommunication administration. (2) For the IBM 3164, any medium that connects the 3164 with a computer.

typematic key. A key that, when held fully pressed, causes an action (such as typing of a character) to be repeated until the key is released.

U

unformatted display. A display screen on which no display field has been defined by the user. See also protected field.

unprotected field. On a display device, a display field in which the user can enter, modify, or erase data.

W

wrap. Synonym for wraparound.

wraparound. The continuation of an operation from the maximum addressable location in storage to the first addressable location.

A

accessories 1-9
 alphanumeric field 5-61
 alphanumeric keys 3-3
 alternate character 5-70
 alternate character (Alt Chr) key 3-3
 alternate cursor (Alt Csr) key 3-4
 angle adjustable legs 2-6
 ASCII control character keys 3-5
 attachment 1-6
 direct attachment 1-6
 remote attachment 1-6
 audible-alarm volume control knob 2-5
 auto send field 5-63
 auxiliary port 2-5

B

BA 5-69
 Backspace key 3-5
 blink character 5-64
 blink field 5-61
 Break key 3-5
 Brightness control knob 2-2
 buffer address 5-69, 5-81
 base format 5-80
 extended format 5-81

C

CA 5-64, 5-69
 Cancel key 3-6
 Caps Lock key 3-6
 cartridge slot 2-4
 CBA 5-69
 CCA 5-69
 Change Keys key 3-7
 character attribute 5-64
 Clear key 3-7
 coiled cable 2-6
 control (Ctrl) key 3-7
 current buffer address 5-69
 current cursor address 5-69
 cursor 3-4
 block 3-4

 high-intensity 3-4
 normal-intensity 3-4
 underline 3-4
 cursor address 5-69
 base format 5-80
 extended format 5-81
 cursor up/down/left/right keys 3-8

D

data stream 5-2
 default color mode 5-10, 5-65
 define function (Def F) key 3-9
 DEL key 3-9
 Delete key 3-9
 delete line (Del Ln) key 3-10
 double-height line 5-66
 double-width line 5-67
 Down key 3-26
 drawer for document 2-4

E

electrical requirements 6-6
 Enter key 3-10
 erase input (Er Inp) key 3-10
 erase to end-of-field (EOF) key 3-11
 erase to end-of-page (EOP) key 3-11
 escape (ESC) key 3-12

F

FA 5-61
 field attribute 5-61
 function (F1 - F24) keys 3-12

G

GID 5-55
 G0 5-76
 G1 5-76

H

high intensity character 5-64
Hold key 3-13
Home key 3-13

I

Insert key 3-13
insert line (Ins Ln) key 3-14
installation planning 6-1

J

Jump key 3-15

K

keyboard 2-6
keyboard cable connector 2-4
keyboard keys 3-2
keypad 3-17
keys 3-2

L

Left key 3-25
line attribute 5-66
Line Draw key 3-16
line feed (LF) key 3-15
Local key 3-16
logic element 2-4
Logic light 2-4

M

main port 2-5
MDT 5-62
message (Msg) key 3-16
messages 3-30
model 11 1-2, 1-5

model 12 1-2, 1-5
modem cable C-2
modified data tag 5-62
must enter field 5-62
must fill field 5-62

N

non-display character 5-64
non-display field 5-61
numeric field 5-61
numeric keypad keys 3-17

O

operator information area 3-30
original mode 4-3, 5-10

P

packing material 1-9
page 5-55
Page key 3-18
partition 5-55
PID 5-55
power-cord socket 2-3
Power-on light 2-2
power-on reset 5-10
power switch 2-2
Print key 3-18
Print Line key 3-18
print message (Pr Msg) key 3-19
problem solving 1-8
program attention (PA1 - PA3) keys 3-17
program color mode 5-10, 5-65
protected field 5-61

R

Reset key 3-19
Return key 3-20
reverse character 5-64
reverse field 5-61
right justified with zero or space field 5-62
Right key 3-25

S

Select key 3-21
Send key 3-21
Send Line key 3-21
send message (Sn Msg) key 3-22
setting up 1-7
Setup key 3-20
Shift keys 3-22
stand 1-5
subscript (Sub) key 3-23
superscript (Super) key 3-23

T

Tab (back tab) key 3-24
Tab key 3-23
test mode 2-4
 offline 2-4
 online 2-4
Test/Normal switch 2-4
Trace key 3-25

U

underline field 5-61
underlined character 5-64
unprotected field 5-61
Up key 3-26

V

VID 5-51
video cable 2-3
video cable connector 2-3, 2-5
video element 2-2
viewport 5-51

W

window 5-55
word length 4-4, 5-4

Statement of Limited Warranty

DEFINITIONS

The term "Machine" as used herein refers to machines and/or their features, model conversions, machine elements and accessories unless the context requires individual reference.

The terms "Machines" and "machines" are used in substitution for the terms "Products" and "products," respectively. Such latter terms appear in selected IBM agreements.

The term "failing machine" refers to machine or machine element requiring warranty service. The term "exchange machine" refers to a machine or machine element provided by IBM to the Customer under an Exchange Type of Service.

The term "programming" shall mean such programming as IBM may make generally available, without separate charge, for machines of the types ordered by the Customer.

WARRANTIES

Machines purchased from IBM under an agreement for purchase of IBM machines or from an IBM approved Remarketer, or an IBM Authorized Dealer, Distributor or Wholesaler will be 1) newly manufactured by or for IBM from new and serviceable used parts which are equivalent to new in performance in these Machines, 2) assembled by or for IBM from serviceable used parts, or 3) Machines which have been previously installed.

IBM warrants that on the Date of Installation each Machine will be in good working order and will conform to IBM's official published specifications which are available upon request.

The Warranty Period for each Machine commences on its Date of Installation.

Warranty service as described herein may be provided by IBM, an applicable IBM Authorized Dealer, or an IBM selected independent contractor, as indicated in the applicable Exhibit.

IBM will not provide warranty service hereunder for Machines or programming located outside the United States and Puerto Rico.

Service and Parts Warranty

Commencing on the Date of Installation of each machine, model upgrade and feature addition, and continuing for the duration of the Warranty Period, IBM agrees to provide the availability of warranty service at no additional charge except as set forth in this subsection or in the subsection entitled "Travel Expense," to keep the machines, model upgrades and feature additions in, or restore them to, good working order. Warranty service will be provided by repairing the machines, model upgrades or feature additions or exchanging the machines under one of the Types of Service described in the subsection entitled "Types of Service." The specific Type of Service for each machine, model upgrade or feature addition will be indicated in the applicable Exhibit. Warranty options that provide alternate Types of Service are available for certain Machines under an IBM maintenance agreement.

It is the Customer's responsibility to determine when a machine or machine element requires warranty service. Before requesting warranty service, the Customer will perform any problem determination procedures provided by IBM, and if service is required, the Customer will follow the service request procedures provided by IBM.

When the Customer presents a failing machine to IBM under a Repair Type of Service, IBM will provide warranty service to restore the failing machine to good working order. Repair Types of Service include remedial maintenance and may include preventive maintenance based on the specific needs of individual machines as determined by IBM. Repair Types of Service may also include lubrication, adjustments and replacement of parts, all as deemed necessary by IBM. Parts, which may be used parts, will be furnished on an exchange basis, and the replaced parts become the property of IBM. When a failing machine is to be repaired under a Repair Type of Service, the Customer is responsible to remove or implement other safeguards to protect all programming, programs, data and removable storage media before such repair.

When the Customer presents a failing machine to IBM under an Exchange Type of Service, it becomes the property of IBM at the time of exchange. An exchange machine may not be new, but will be in

good working order, and becomes the Customer's property at the time of exchange. IBM reserves the right to verify that warranty service for a failing machine is required prior to providing an exchange machine. When a failing machine is exchanged, the Customer will remove all programming, programs, data and removable storage media, and all non-IBM parts, options, alterations and attachments before such exchange. The Customer agrees that all such items not removed will be deemed to have been discarded by the Customer. The Customer will not present to IBM a failing machine for exchange which is defaced, altered or damaged beyond repair. (Repair is as described in the preceding paragraph.) However, if upon inspection IBM determines it has received in exchange a failing machine in such condition, the exchange will be nullified and each party will return to the other the machine or machine element in its possession.

The Period of Warranty Service Availability for IBM On-Site Repair and IBM On-Site Exchange Types of Service are specified in the applicable Exhibit. Outside such Period, warranty service, if requested by the Customer and provided by IBM, will be subject to charge for travel expense plus travel, waiting and service time at IBM's then applicable hourly service rates and minimum charges; however, there will be no additional charges for parts.

The Period of Warranty Service Availability for Customer On-Site Exchange, Customer Carry-In Exchange and Customer Carry-In Repair Types of Service are specified in the applicable Exhibit.

Warranty service described herein does not assure uninterrupted operation of the Machines. IBM may, at its option, store on the Customer's premises maintenance equipment and/or parts that IBM deems necessary to fulfill this warranty.

During the Warranty Period, engineering changes, determined applicable by IBM, will be controlled by IBM and installed as specified by IBM on the Machines. The Customer may, by providing notice subject to written confirmation by IBM, elect to have only mandatory changes, as determined by IBM, installed on Machines so designated.

IBM shall have full, free and safe access to the Machines to provide IBM On-Site Types of Service thereon. The Customer shall promptly inform IBM of any change in a Machine's location during the Warranty Period.

In respect to warranty service provided by IBM, the Customer is responsible for all risk of loss of, or damage to, Machines owned by other than IBM during the period such Machines are in transit to and from IBM, except for loss or damage caused by IBM's negligence. However, IBM is responsible for risk of loss of, or damage to, Machines owned by other than IBM while in possession of IBM or in transit from IBM by an IBM selected carrier whose expenses were prepaid by IBM.

The Customer represents and warrants that, at the time a failing machine becomes IBM's property, it will be free of any outstanding liens, security interests or other encumbrances held by any third party.

If the Warranty Period expires on a Friday or Saturday, it will be extended so that the last day of such Warranty Period will be on the following Sunday.

Types of Service

IBM On-Site Repair (IOR)

IBM will provide warranty service for the failing machine at the Customer's location.

IBM On-Site Exchange (IOE)

IBM will 1) deliver the exchange machine to the Customer's location, 2) disconnect the failing machine, 3) connect the exchange machine, 4) verify its operation, and 5) remove the failing machine from the Customer's location.

Customer On-Site Exchange (COE)

IBM will have an exchange machine delivered to the Customer's location. The Customer will 1) disconnect the failing machine and prepare it for shipment to IBM, 2) connect the exchange machine, and 3) verify its operation. The Customer will follow IBM's instructions regarding the shipment of the failing machine to IBM. Such shipment will be at IBM's expense.

Customer Carry-In Exchange (CCE)

The Customer will 1) deliver the failing machine to an IBM Service/Exchange Center or other IBM designated location, 2) pick up the exchange machine and take it to the Customer's location, 3) connect it, and 4) verify its operation.

The Customer, in lieu of such delivery and pick up, may ship the failing machine prepaid, in the original shipping container or equivalent, to one of the designated IBM Service/Exchange Centers designated for this delivery method. IBM will then ship the exchange machine to the Customer's locations, prepaid, within the United States and Puerto Rico.

Customer Carry-In Repair (CCR)

The Customer will 1) deliver the failing machine to an IBM Service/Exchange Center or other IBM designated location, 2) when the failing machine is repaired, pick it up and return it to the Customer's location, 3) connect it, and 4) verify its operation.

The Customer, in lieu of such delivery and pick up, may ship the failing machine prepaid, in the original shipping container or equivalent, to one of the IBM Service/Exchange Centers designated for this delivery method. IBM will ship the repaired machine to the Customer's location, prepaid, within the United States and Puerto Rico.

Programming

IBM warrants that, when shipped to the Customer, programming designated by IBM for use with a Machine and for which programming services are available will conform to IBM's official published specifications which are available upon request.

IBM does not warrant that functions contained in programming will operate in the combinations which may be selected for use by the Customer or will meet the Customer's requirements.

ALL OTHER PROGRAMMING IS DISTRIBUTED ON AN "AS IS" BASIS.

Additional Provisions for Features and Model Conversions

IBM's warranty for each feature addition or model upgrade requires that the machine on which it is installed is at the then current engineering-change level, is the specific serial-numbered machine for which it was ordered and has been modified only with changes obtained from IBM specifically for that serial-numbered machine. If these conditions are not met, IBM will attempt to install non-Customer set-up feature additions and model upgrades on the machine, and, if such attempt results in an incorrectly functioning machine, upon Customer request and at IBM's then applicable hourly service rates and minimum charges, parts and material prices and travel expense, IBM will remove the features and/or model upgrades and restore the machine to its prior condition. If such features or model upgrades did not involve the removal of parts which became the property of IBM, such features and model upgrades remain the property of the Customer. If such features and model upgrades did involve the removal of parts which became the property of IBM, such features and model upgrades become the property of IBM and the restored parts become the property of the Customer.

For a feature removal, model downgrade or reinstallation of a previously purchased feature or model conversion, a three-month parts warranty will apply to additional parts, if any, supplied by IBM.

Additional Provisions for Accessories

Accessories have a three-month Warranty Period unless otherwise specified by IBM. During the Warranty Period, the Customer will remove any defective or failing accessory and ship it prepaid to the designated IBM location. IBM will replace such accessory and ship the replacement to the Customer without charge.

Additional Provisions for Machines Containing Funds

The Customer is responsible for removing, controlling and replacing or reloading funds contained in the Machines. IBM will service Machines containing funds only when the cash container cannot be opened prior to repair by IBM, in which case the Customer will remove the funds as soon as the container has been opened.

Services for Additional Charge During the Warranty Period

The services for additional charge described in this subsection are not warranty services. However, unless such services are provided

under another written agreement between the Customer and IBM, during the Warranty Period, the following services, if available, will be provided by IBM to the Customer at IBM's i) then generally available hourly service rates and minimum charges for IBM service time, including travel and waiting time, ii) parts and material prices then generally in effect, and iii) charges for travel and shipping expense, all as applicable;

- 1) Repair of Machine damage, replacement of parts or increase in service time caused by --
 - a) failure to continually provide a suitable environment prescribed by IBM including adequate space, electrical power, air conditioning and humidity control;
 - b) neglect; misuse, including use of the Machines for purposes other than for which designed;
 - c) accident; disaster, including water, wind and lightning, transportation; vandalism or burglary;
 - d) alterations, including any deviation from IBM's Machine design;
 - e) attachments, including any interconnection to the Machine of non-IBM equipment or devices not under an IBM maintenance agreement;
 - f) IBM Machines, other Machines or accessories, except those IBM Machines, other Machines or accessories that are owned by IBM, under warranty from IBM or under an IBM maintenance agreement;
 - g) conversions from one IBM model to another or installation or removal of an IBM feature whenever any of these activities was performed by other than IBM, except that this item (g) will apply only during the first three-month period subsequent to such Machine modification; and
 - h) maintenance or repair of the Machine not performed by IBM.
- 2) Repair of Machine damage, replacement of maintenance parts (due to other than normal wear) or repetitive service calls caused by the use of, inadequate use of, or failure to use, supplies;
- 3) Service for accessories other than as provided in the subsection entitled "Additional Provisions for Accessories" of this Section;
- 4) Inspection of altered Machine;
- 5) Replacement or addition of parts and increase in service time associated with the installation by IBM of an engineering change, required due to the conversion of one IBM model to another or installation or removal of an IBM feature whenever any of these activities was performed by other than IBM;
- 6) Rearrangement or relocation of Machines and provision of necessary materials; and
- 7) Replacement of a part not furnished for the Machine by IBM with a directly interchangeable IBM maintenance part, and any increase in service time associated with such activity, except that IBM will not replace any part which is included in an alteration.

Travel Expense

There will be no charge for travel expense associated with warranty service or programming service during the applicable Period of Warranty Service Availability except that actual travel expense will be charged when the site at which the Machine is located is normally inaccessible by both private automobile and scheduled public transportation.

Exclusions

The warranties stated herein do not include 1) furnishing supplies, painting or refinishing the Machines or furnishing material therefor, 2) electrical work external to the Machines, 3) installation, maintenance or removal of alterations or attachments to the Machines, and 4) any service which is impractical for IBM to render because of alterations in, or attachments to the Machines. IBM does not warrant that the operation of Machines or programming will be uninterrupted or error free or that all programming errors will be corrected.

THE FOREGOING WARRANTIES ARE IN LIEU OF ALL OTHER WARRANTIES, EXPRESS OR IMPLIED, INCLUDING, BUT NOT LIMITED TO THE IMPLIED WARRANTIES OF MERCHANTABILITY AND FITNESS FOR A PARTICULAR PURPOSE.

IBM 3164 ASCII Color Display Station Description

**READER's
COMMENT
FORM**

GA18-2317-1

This manual is part of a library that serves as a reference source for systems analysts, programmers, and operators of IBM systems. This form may be used to communicate your views about this publication. They will be sent to the author's department for whatever review and action, if any, is deemed appropriate. Comments may be written in your own language; use of English is not required.

IBM may use or distribute any of the information you supply in any way it believes appropriate without incurring any obligation whatever. You may, of course, continue to use the information you supply.

Note: *Copies of IBM publications are not stocked at the location to which this form is addressed.*

Please direct any requests for copies of publications, or for assistance in using your IBM system, to your IBM representative or to the IBM branch office serving your locality.

Possible topics for comment are:

Clarity Accuracy Completeness Organization Coding Retrieval Legibility

If you wish a reply, give your name and mailing address:

Note: Staples can cause problems with automated mail sorting equipment.
Please use pressure sensitive or other gummed tape to seal this form.

Cut or Fold Along Line

What is your occupation? _____

Number of latest Technical Newsletter (if any) concerning this publication: _____

Thank you for your cooperation. No postage stamp necessary if mailed in the U.S.A. (Elsewhere, an IBM office or representative will be happy to forward your comments.)

Reader's Comment Form

Cut or Fold Along Line

Fold and tape

Please Do Not Staple

Fold and tape



NO POSTAGE
NECESSARY
IF MAILED
IN THE
UNITED STATES

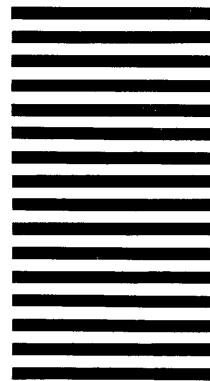

BUSINESS REPLY MAIL
FIRST CLASS PERMIT NO. 40 ARMONK, N.Y. U.S.A.

POSTAGE WILL BE PAID BY ADDRESSEE:

INTERNATIONAL BUSINESS MACHINES CORPORATION
DEPARTMENT 6R1 J
180 KOST ROAD
MECHANICSBURG, PA 17055

Fold and tape

Please Do Not Staple

Fold and tape

IBM 3164 ASCII Color Display Station Description Printed in U.S.A. GA18-2317-1



IBM 3164 ASCII Color Display Station Description

**READER's
COMMENT
FORM**

GA18-2317-1

This manual is part of a library that serves as a reference source for systems analysts, programmers, and operators of IBM systems. This form may be used to communicate your views about this publication. They will be sent to the author's department for whatever review and action, if any, is deemed appropriate. Comments may be written in your own language; use of English is not required.

IBM may use or distribute any of the information you supply in any way it believes appropriate without incurring any obligation whatever. You may, of course, continue to use the information you supply.

Note: *Copies of IBM publications are not stocked at the location to which this form is addressed.*

Please direct any requests for copies of publications, or for assistance in using your IBM system, to your IBM representative or to the IBM branch office serving your locality.

Possible topics for comment are:

Clarity Accuracy Completeness Organization Coding Retrieval Legibility

If you wish a reply, give your name and mailing address:

Cut or Fold Along Line

Note: Staples can cause problems with automated mail sorting equipment. Please use pressure sensitive or other gummed tape to seal this form.

What is your occupation? _____

Number of latest Technical Newsletter (if any) concerning this publication: _____

Thank you for your cooperation. No postage stamp necessary if mailed in the U.S.A. (Elsewhere, an IBM office or representative will be happy to forward your comments.)

Reader's Comment Form

Cut or Fold Along Line

Fold and tape

Please Do Not Staple

Fold and tape



NO POSTAGE
NECESSARY
IF MAILED
IN THE
UNITED STATES



BUSINESS REPLY MAIL
FIRST CLASS PERMIT NO. 40 ARMONK, N.Y. U.S.A.

POSTAGE WILL BE PAID BY ADDRESSEE:

INTERNATIONAL BUSINESS MACHINES CORPORATION
DEPARTMENT 6R1 J
180 KOST ROAD
MECHANICSBURG, PA 17055

Fold and tape

Please Do Not Staple

Fold and tape

IBM 3164 ASCII Color Display Station Description Printed in U.S.A. GA18-2317-1

